



Clark County, WA Bicycle and Pedestrian Master Plan

PREPARED BY:
Alta Planning + Design

October 2010



Acknowledgments

Clark County appreciates the efforts of the numerous residents who participated in the development of this Plan. Their creativity, energy, and commitment to the future of the County were the driving force behind this planning effort. In addition, the following citizens, County staff, and other agency and organization members significantly contributed to the development of the Bicycle and Pedestrian Master Plan.

Oliver Orjiako, Community Planning Director

The Clark County Bicycle Advisory Committee

Volunteers who assisted with the bicycle inventory: Phil Brown, Patricia McConaughy, Bill Maiden,

Steve Durspek, Joe Gruelich, Dennis Johnson

Bicycle and Pedestrian Advisory Committee

Laurie Lebowsky - Clark County Community Planning

Gary Albrecht - Clark County Community Planning

Phil Brown - Bike Advisory Committee

Ken Burgstahler, Washington Department of Transportation

Bill Byrd - Volksmarch

Jennifer Campos - City of Vancouver

Michael Derleth - Clark County Public Works

Scott Deutsch - Evergreen School District

Steve Durspek - Bike Advisory Committee

Chuck Frayer - Vancouver-Clark Parks Board

Richard Gamble - Clark County Public Works

Lisa Goorjian - Vancouver-Clark Parks & Recreation

Brendon Haggerty - Community Health

Jennifer Halleck - Vancouver School District

Jonnie Hyde - Community Health

Leah Jackson - Bike Me

Steven Koch - Citizen

Sarah Lawler - Youth Commission

Patricia McCounaughy - Bike Advisory Committee

Tricia Mortell - Citizen

Sharon Pesut - Community Choices

Steve Schulte - Clark County Public Works

Charlene Welch - Citizen

Technical Advisory Committee

Mike Butts-Clark County Development Services

Jennifer Campos-City of Vancouver Transportation

Curleigh Carothers-City of Camas Public Works

Dale Miller-La Center Planning

Debbie Elven-Snyder- C-Tran

Michael Derleth-Clark County Public Works

Tom Grange-Clark County Public Works

Ejaz Khan-Clark County Public Works

Gary Albrecht-Clark County Community Planning

Lisa Goorjian-Vancouver-Clark Parks Department

Mark Herceg-City of Battle Ground

Ali Safayi-Clark County Development Engineering

Steve Wall-City of Ridgefield

Will Noonan-City of Washougal

Alta Planning + Design

Mia Birk, Principal-in-Charge

Mike Tresidder, Project Manager

Hannah Kapell, Planner



This page intentionally left blank

Table of Contents

Executive Summary	i
Chapter 1. Introduction	1
Purpose	1
Public Involvement	2
Vision, Goals, and Actions.....	3
Policy Considerations for Non-motorized Future Planning Efforts	4
Plan Organization and Use	4
Chapter 2. Existing Conditions	7
Jurisdictional Responsibilities.....	7
Pedestrian Infrastructure Overview	7
Bicycle Infrastructure Overview	8
Trails and Connections.....	13
Chapter 3. Recommended Policies	19
Chapter 4. Recommended Prioritized Network.....	27
Project Prioritization	28
Recommended Walkway Improvements	29
Recommended On-Street Bikeways.....	34
Recommended Regional Pathway Improvements.....	43
Chapter 5. Bicycle Parking Standards and Guidelines	49
Bicycle Parking Facility Types.....	49
Bicycle Parking Supportive Policies	55
Bicycle Parking Standards Best Practices	57
Chapter 6. Design Program.....	59
National and State Guidelines / Best Practices	60
Matrix of Best Practices	63
Chapter 7. Education and Outreach Strategies	81
Existing Education and Outreach Efforts	81
Program Recommendations	83
Chapter 8. Implementation Plan	87
Implementation Strategies.....	87

Table of Contents

Current Clark County Bicycle and Pedestrian Program Funding	90
Potential Funding Sources.....	92
Appendix A. Public Outreach Comments.....	99
Appendix B. Existing Conditions Tables	137
Appendix C. Prioritization Criteria	171
Appendix D. Walk Routes to School	177
Appendix E. Complete Project Lists.....	183
Appendix F. Funding Sources	207
Appendix G. Education and Encouragement Programs	219
Appendix H. Bicycle and Pedestrian Advisory Committee Work Program.....	241
Appendix I. Rapid Health Impact Assessment	247

List of Tables

Table 1. Summary of Public Involvement.....	2
Table 2. Shoulder Bikeways in Clark County	8
Table 3 Existing Bike Lanes in Clark County	12
Table 4. CTRAN Bicycle Parking Inventory	16
Table 5. Prioritization Criteria.....	28
Table 6. Priority Identified Sidewalk Projects	30
Table 7. Priority Sidewalk Project Connections.....	33
Table 8. Top Prioritized On-Street Bikeway Projects	35
Table 9. Priority On-Street Bikeway Project Connections	37
Table 10. Top Prioritized Roadway Restriping Projects.....	41
Table 11. Priority Roadway Restriping Project Connections.....	42
Table 12. Priority Trail Projects.....	45
Table 13. Priority Trail Project Connections	46
Table 14. Short-Term Bicycle Rack Placement Guidelines	52
Table 15. Vancouver Bicycle Parking Recommended Standards	56
Table 16. Minimum Required Bicycle Parking Spaces, DLCD	58
Table 17. Factors that Affect the Use of Bike Lanes or Shoulder Bikeways.....	62
Table 18. Sidewalk Issues.....	63

Table 19. Pedestrian Crossing Issues64

Table 20. Bike Lanes.....66

Table 21. Bicycle Boulevards.....68

Table 22. Crossing/Intersection Issues68

Table 23. Safety Design Guidelines70

Table 24. Bicycle Parking Design Guidelines.....71

Table 25. Trail Design Guidelines73

Table 26. Maintenance and Street Closures Design Guidelines77

Table 27. Clark County Sidewalk Network90

Table 28. Pedestrian and Bicycle Construction Funding91

Table 29. Sidewalk Infill Program91

Table 30. Bikeway Treatments.....92

Table 31. Summary of Funding Options.....96

Table 32. **Potential Local Funding Sources**97

Table 33 July 2010 Open House Comments.....99

Table 34. August 2010 Comments.....101

Table 35. Draft Plan Comments107

Table 36. Bicycle and Pedestrian Network Development Policies143

Table 37. Policies Related to Jurisdictional Cooperation146

Table 38. Traffic Management and Demand Management Policies.....147

Table 39. Policies Related to Supporting Programs148

Table 40. Policies Related to Parks.....150

Table 41. Policies Related to Funding154

Table 42. Regional Bicycle Facilities and Shared Use Paths.....155

Table 43. Battle Ground Bicycle Facilities and Shared Use Paths157

Table 44. Camas Bicycle Facilities and Shared Use Paths.....158

Table 45. La Center Bicycle Facilities and Shared Use Paths.....159

Table 46. Ridgefield Bicycle Facilities and Shared Use Paths.....160

Table 47. Vancouver Bicycle Facilities and Shared Use Paths162

Table 48. Vancouver Pedestrian Facilities162

Table 49. Project Prioritization Elements.....169

Table of Contents

Table 50. Project Criteria.....	171
Table 51. Project Criteria and Scoring.....	172
Table 52. Summary of Health Outcomes Points.....	173
Table 53. Socioeconomic Status Points.....	173
Table 54. Medium and Low Sidewalk Project List.....	183
Table 55. Medium and Low On-Street Bikeway Projects.....	187
Table 56. Prioritized Off-Street Trail Projects.....	191
Table 57. Additional Education and Encouragement Programs.....	239

List of Maps

Map 1. Bicycle Inventory.....	9
Map 2. Vancouver-Clark Park and Recreation Trails of Clark County Map.....	14
Map 3. Existing Transit Service in Clark County (map from C-TRAN).....	17
Map 4. Priority Sidewalk Projects.....	31
Map 5. Priority Bikeway and Trail Projects.....	39
Map 6. Aggregated Public Feedback Map, North.....	103
Map 7. Aggregated Public Feedback Map, South.....	105
Map 8. Clark County Major Roadway Classifications.....	140
Map 9. School District Boundary Map.....	181
Map 10. Existing and Recommended Bicycle, Pedestrian, and Trail Facilities, Southwest.....	197
Map 11. Existing and Recommended Bicycle, Pedestrian, and Trail Facilities, Southeast.....	199
Map 12. Existing and Recommended Bicycle, Pedestrian, and Trail Facilities, East.....	201
Map 13. Existing and Recommended Bicycle, Pedestrian, and Trail Facilities, Northeast.....	203
Map 14. Existing and Recommended Bicycle, Pedestrian, and Trail Facilities, Northwest.....	205

Introduction

A national surge in interest in alternative modes of transportation has resulted from increasing concerns with health, the cost of gas, or even finding a way to relieve stress. The Clark County Bicycle and Pedestrian Master Plan presents a 20-year vision and implementation strategy that seeks to increase the number of people walking and bicycling while improving walking and bicycling safety throughout the county.

Why Bicycling and Walking?

Bicycling and walking are low-cost means of transportation that are non-polluting, energy-efficient, versatile, healthy, and fun. Everyone is a pedestrian at some point, whether walking a dog, taking a lunch break, or accessing transit. Bicycling is an active choice for transportation that reduces vehicle miles traveled. The many advantages to walking and bicycling include:

- **Bicycling and walking are good for the economy.** Bicycling makes up \$133 billion of the US economy, funding 1.1 million jobs.¹
- **Walkable, bikeable neighborhoods are more liveable and attractive,** increasing home values and resulting in increased wealth for individuals and additional property tax revenue.²
- **Walking and bicycling increase spending on local goods and services.** By replacing short car trips, bicycling and walking can help families defray transportation costs.³

1 Flusche, Darren for the League of American Bicyclists. (2009). *The Economic Benefits of Bicycle Infrastructure Investments*.

2 Cortright, Joe for CEOs for Cities. (2009). *Walking the Walk: How Walkability Raises Home Values in U.S. Cities*.

3 Center for Neighborhood Technology. (2005). *Driven to Spend: Pumping Dollars out of Our Households and Communities*.

- **Walking and bicycling are good for public health.** Bicycling for exercise can reduce the cost of spending on health care by as much as \$514 a year.⁴
- **More people walking and bicycling increase safety for others.** In a community where twice as many people walk, an individual walking has a 66 percent reduced risk of being injured by a motorist.⁵

Clark County benefits from several popular trails, including the Lewis and Clark Discovery Greenway and the Padden Parkway Trail, as well as a number of planned trails, most notably the Chelatchie Prairie Greenway Trail. In addition, the County has 26 miles of shoulder bikeways and 43 miles of bike lanes developed.

Challenges

The County also faces several challenges to the development of the Bicycle and Pedestrian Master Plan. Interstates 5 and 205 are major barriers to pedestrian and bicycle travel. The existing bikeway, sidewalk and trail networks are discontinuous in places. In addition, the County has completed two bicycle plans but no pedestrian plan, and the County lacks information about existing facilities.

Most roads in Clark County have already been built, requiring bikeways, sidewalks, and trails to be developed within existing right-of-ways. In addition, steep topography and long distances are considerable barriers to increasing the number of county residents bicycling for transportation, exercise, or fun.

4 Feifei, W., McDonald, T., Champagne, L.J., and Edington, D.W. (2004). *Relationship of Body Mass Index and Physical Activity to Health Care Costs Among Employees*. Journal of Occupational and Environmental Medicine. 46(5):428-436

5 Jacobsen, P.L. (2003). Safety in numbers: more walkers and bicyclists, safer walking and bicycling. Injury Prevention 9:205-209.

When the spirits are low, when the day appears dark, when work becomes monotonous, when hope hardly seems worth having, just mount a bicycle and go out for a spin down the road, without thought on anything but the ride you are taking.

- Arthur Conan Doyle



Walking and bicycling are safe and healthy modes of transportation and recreation, which contribute to quality of life

The goals and objectives will guide the way the public improvements are made, where resources are allocated, how programs are operated, how department priorities are determined, and how private development is designed. The Plan goals and objectives will be adopted into the County's Comprehensive Plan when it is updated in 2014.

Goal 1: Developing a Bicycle and Pedestrian Network

Objective 1-1: Implement the Clark County Bicycle and Pedestrian Master Plan to expand travel opportunities for transportation and recreation.

Objective 1-2: Identify county-wide networks of bicycle and pedestrian facilities that augments local networks identified by each city.

Objective 1-3: Encourage large employers, developers, and other organizations to provide secure short and long-term bicycle parking in employment and commercial areas, in multifamily housing, at schools, and at transit facilities, including covered and/or attended parking.

Objective 1-4: Increase the number of bicycle transit trips and pedestrian access to transit.

Objective 1-5: Develop and improve trails within parks.

Goal 2: Jurisdictional Coordination

Objective 2-1: Facilitate coordination and cooperation among local jurisdictions in development of the bikeways and pedestrian facility recommendations.

Plan Organization and Use

The Plan is organized as follows:

- Chapter 1: Introduction provides an overview of this plan and its purpose.
- Chapter 2: Existing Conditions, summarizes the conditions of the county's pedestrian, bicycle, and trail network.
- Chapter 3: Recommended Policies, presents bicycle- and pedestrian-supportive policies and action items.
- Chapter 4: Recommended Prioritized Network, depicts the recommended system of bikeways, walkways, and trails.
- Chapter 5: Bicycle Parking Standards and Guidelines, provides an overview of parking design and policy best practices.
- Chapter 6: Design Program, outlines local, state and national best practices for pedestrian, bicycle, and trail facility types.
- Chapter 7: Education and Outreach Strategies, describes programs the County and/or local agencies could implement to promote walking and bicycling.
- Chapter 8: Implementation Plan, identifies potential funding strategies and supporting policies.



Bicycle parking can determine whether someone can choose to bicycle to work, the store, or to meet friends for coffee.

The Bottom Line: Where to Start

The recommended bikeways, walkways, and trails connect key destinations in and around Clark County. Improvements vary from low-cost measures yielding immediate results, such as re-stripping of streets to accommodate bike lanes, to longer-term strategies for transforming Clark County into a truly bicycle- and pedestrian-friendly community.

An inventory of existing on-street bikeways was conducted by volunteers for this Plan. The inventory identified locations where roadway shoulders are sufficiently wide to provide bike lanes through low-cost re-stripping efforts. Other bikeway recommendations will be implemented through a combination of roadway restriping, road diets (reducing or removing a parking, turn, or travel lane), or through shoulder widening.

Sidewalk project recommendations considered previously-identified, connected (non-cul-de-sac) facilities within the urban growth boundary. The recommended sidewalk project list is limited to previously-conducted inventories and is distinct from the existing sidewalk infill program. As the County accumulates additional data, the projects and priorities will shift.



Implementation of the Clark County Bicycle and Pedestrian Master Plan will encourage and enable residents of all ages to walk and bicycle.

Priority Infrastructure Projects

This Plan focuses recommendations on walkways, bikeways, and trails that connect key destinations in and around Clark County. Recommendations are designed to overcome barriers to walking and bicycling, providing access where destinations are separated by major highways and thoroughfares. In many of these areas, residents and visitors have no choice but to drive to every destination.

The top-priority projects provide expanded options for transportation and recreation and are projects that could be implemented in the near future. The map below shows the priority projects identified in this Plan.

The priority projects fell into four categories:

- **Priority sidewalk projects** are identified from sidewalk inventories that have been conducted in some sub-areas. This list will be updated as additional information is available.
- **Priority road restriping projects** are on-street bicycle facilities on roadways with sufficient width to strips bike lanes.
- **Priority bikeway projects** are on-street bicycle facilities on roadways that would require additional treatments to accommodate bicyclists.
- **Priority trail projects** are shared-use trails, side paths, and primitive trails that have been identified as priorities by the Vancouver-Clark Parks Department.

Goal 3: Traffic Management/ Demand Management

Objective 3-1: Encourage use of alternative types of transportation, particularly those that reduce mobile emissions (bicycle, walking, carpools, and public transit) by implementing Transportation Demand Management Strategies aimed at reducing the number of drive alone trips.

Objective 3-2: Ensure bicycle and pedestrian facilities are designed to the most recent federal, state and local design guidelines and best practices.

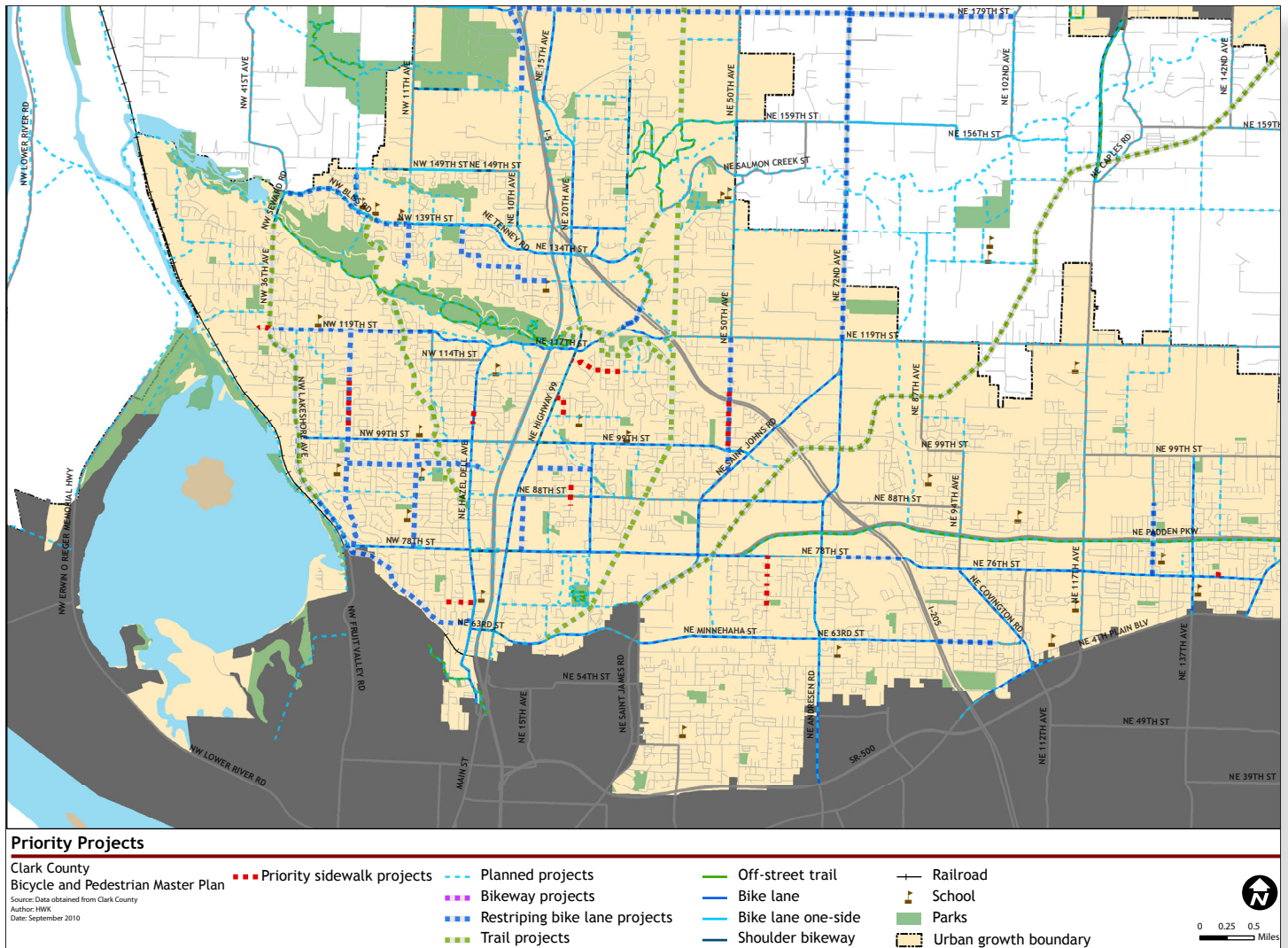

The top-tier projects focus on routes that provide the best connectivity benefits, improving nonmotorized routes to parks, schools, and community centers throughout Clark County.

Goal 4 Education, Encouragement and Safety Programs

Objective 4-1: Promote bicycle and pedestrian safety and increased bicycling and walking through education and encouragement activities.

Objective 4-2: Promote increased bicycling and walking for transportation.

Objective 4-3: Promote bicycle and pedestrian safety and increased bicycling and walking through enforcement activities.

Objective 4-4: Maintain and improve the quality, operation, and integrity of bikeway and walkway network facilities.

Goal 5 Funding

Objective 5-1: Work to fund construction of the bicycle and pedestrian improvements in this Plan and maximize the amount of local, state, and federal funding for bikeway and walkway facilities that can be received by agencies in Clark County.

Objective 5-2: Pursue voluntary and private funding sources for bicycle improvements.

Goal 6 Active Transportation Planning and Bicycle- and Pedestrian-Supportive Land Uses

Objective 6-1: Increase development practices that are supportive of walking and cycling.

Objective 6-2: Improve bicycle and pedestrian access to nutritious food.

Recommended Programs

Partnerships between the County, municipalities, community advocacy/advisory groups and businesses could create and enhance programs to enable pedestrians and cyclists to safely and easily travel through the county.

- **Revise the current Bicycle Advisory Committee (BAC) to include pedestrian issues.** The BPAC will advise the county and individual jurisdictions on technical issues related to walking and bicycling.
- **Create a school education/encouragement program.** In partnership with municipalities and community organizations Clark County should build on successful SRTS programs found at both Washington and Daybreak elementary and primary schools.
- **Establish a ‘Clarklovia’ or Ride (and Walk) the Drive.** In partnership with neighborhoods, the County could sponsor an event where residents can bike, walk, and run in the streets without auto traffic.



Safe Routes to School and other educational programs improve safety and encourage students to walk and bicycle

Implementation

Most bicycle facilities and sidewalks in the county are developed through capital road projects or private development. Capital road projects are funded by gas tax revenues augmented by multiple state and federal grants, including several SAFTEA-LU programs. County code also requires that development projects upgrade street frontage to current standards. Infill projects or “spot” improvements in the sidewalk network are filled in via an ongoing program that is allocated County Road Fund money during annual updates to the county Transportation Improvement Program (TIP).

Implementation of this Plan will occur through the following strategies:

- Continue funding bicycle and pedestrian projects with the capital budget.
- Leverage local funds to pursue grant opportunities.
- Establish public/private funding opportunities and other partnership opportunities.
- Work with the Bicycle and Pedestrian Committee to pursue funding opportunities.

The project advisory committees reviewed many funding sources that have been used or proposed for bicycle and pedestrian improvements and maintenance. The newly-formed Bicycle and Pedestrian Advisory Committee will establish a working group to develop partnerships for identifying funding opportunities for bicycle and pedestrian projects. The BPAC also recommended the following funding action items:

- Create a Transportation Benefit District (TBD)
- Establish a voluntary fund for retrofitting streets with bike lanes
- Explore partnerships with the private sector to support the County’s Bicycle and Pedestrian Program

Chapter 1. Introduction

Increasing interest in alternative modes of transportation originates from concerns with public health, the cost of gas, environmental preservation, and transportation safety. Many people in Clark County choose to bicycle or walk for transportation and recreation, and the County wants to increase the number of people walking and bicycling.

The Clark County Bicycle and Pedestrian Master Plan provides a vision and implementation strategy for how Clark County can improve conditions for bicycling and walking over the next twenty years. The Plan envisions an interconnected bicycle and pedestrian network that provides routes to city centers, schools, transit, parks and recreational facilities. Once achieved, this Plan will improve Clark County residents' health, enhance their quality of life, help improve and protect the County's natural resources, and be a source of pride to the community.

Purpose

Two previous bicycle plans have been completed in Clark County: the 1972 Bicycle Plan and 1996 Clark County Bicycle Commute Plan. The first bicycle plan was a very basic plan addressing the modern trend of bicycling, which started in the early 1970's. The purpose of the 1996 Bicycle Commute Plan was to develop a strategy to encourage more people to use bicycling as a way to ride to work. Unfortunately, the County has never developed a plan to address pedestrians.

Until now, Clark County did not have a pedestrian and bicycle plan with goals and objectives for promoting bicycling and walking in Clark County. Although several county documents are supportive of bicycling and walking, no single document discusses the overall objectives of promoting bicycling and walking in Clark County.

The *Clark County Bicycle and Pedestrian Master Plan* will not be a comprehensive plan for pedestrians, but it will serve as a beginning. This Plan provides detailed guidelines about how to develop future action items to address pedestrian issues. Future sub-area plans will provide detailed inventories and pedestrian plans for unincorporated Clark County, including the Three Creeks Special Planning Area and areas around Hazel Dell, Felida, Lake Shore, Salmon Creek, and the fairgrounds. In addition, this Plan addresses walking routes to school, as well as establishing benchmarks for increasing the number of people walking in the county.

The Bicycle and Pedestrian Advisory Committee has developed a work program to begin implementation and continue bicycle and pedestrian



Figure 1. The Clark County Bicycle and Pedestrian Master Plan will encourage residents to travel by foot and by bicycle for transportation and recreation.



Figure 2. Everyone is a pedestrian at some point in the day, whether they take a walk for lunch or walk to transit.

planning efforts in the County. The existing sidewalk infill program will be integrated with the criteria and recommendations established in this Plan.

Public Involvement

Initially, the public process for developing the plan was comprised of two separate citizen's groups: the Pedestrian Advisory Committee, and the Clark County Bicycle Advisory Group. To improve efficiency, these committees were combined to form the Bicycle and Pedestrian Advisory Committee. The Technical Advisory Committee included staff from affected jurisdictions as well as a representative of the private development consulting community.

The existing Vancouver-Clark Parks Department's *Regional Trail and Bikeway Systems Plan* serves as a foundation for the Clark County Bicycle and Pedestrian Master Plan planning process by providing regional goals and proposing projects. The Bicycle and Pedestrian Master Plan builds on the *Regional Trail and Bikeway Systems Plan* and other previous planning efforts to provide clear direction to the county, developers, and residents regarding specific pedestrian or bicycle facility location and design.

The public involvement plan facilitated a shared vision of the non-motorized transportation system throughout Clark County. Community endorsement of any plan is critical to the long term success of the recommended system and to the ability of the County to implement the plan. Agencies, stakeholders, and the general public were encouraged to provide input as shown in Table 1.

Table 1. Summary of Public Involvement

Event/ Meeting	Timing
Open Houses	<ul style="list-style-type: none"> July 2009, Fisher's Landing Transit Center July 2009, Public Service Center July 2010, Battle Ground Community Center August 2010, Public Health Conference Room
Board of Commissioners Work Session	<ul style="list-style-type: none"> July 2009 August 2010
Planning Commission Work Session	August 2010
Planning Commission Hearing	October 2010
Board of Commissioners Work Session	November 2010
Board of Commissioners Hearing	November 2010



Figure 3. The Plan seeks to enhance alternative mode choice options.

Vision, Goals, and Actions

The Clark County Bicycle and Pedestrian Plan aims to provide a system complementary to the existing/future roadway and trail network for access to major destination points. The system plan promotes alternate mode choice; reduces pedestrian and bicycle travel times; seeks to improve pedestrian and cyclist safety via physical infrastructure, improvement and maintenance, enhanced design treatment; and promotes increases in walking and biking through education, encouragement and enforcement programs. The County partnered with schools, citizen groups, cities, state agencies and other public groups to identify opportunities to enhance non-motorized transportation opportunities throughout Clark County.

Vision

The Clark County Bicycle and Pedestrian Plan envision an interconnected transportation system where:

- People can bicycle or walk safely and conveniently to all destinations within reasonable walking or bicycling distance;
- Schoolchildren will have safe routes to walk and cycle to school;
- People can walk or ride to and from their transit stops and have a comfortable and convenient place to wait or transfer;
- Bicyclists and pedestrians can enjoy Clark County's natural beauty;
- Appropriate transportation choices are available to all;
- Transportation facilities are designed to encourage active transportation; and
- Clark County will promote the economic development opportunities related to bicycling.

Plan Actions

In order to achieve this vision, the *Clark County Bicycle and Pedestrian Master Plan* undertook the following action items:

- Develop a prioritized list of bicycle and pedestrian improvements that provides access to bicycle and pedestrian destinations, including cities, schools, parks, employment centers, transit centers, and regional trails.
- Update existing pedestrian and bicycle design standards, and apply new design standards for pedestrians and bicyclists to provide routes usable by pedestrians and cyclists of all ages and skill levels.
- Encourage active transportation through high-quality design and supporting programs and events.

- Promote economic development opportunities related to bicycling by developing a scenic county route and coordinating with other groups to sponsor events.
- Develop guidelines for secure bicycle storage facilities and racks in activity centers, large employment centers, colleges and universities, and at major transit stops.
- Develop recommendations that provide Clark County, community partners and local agencies the tools and guidance necessary to implement bicycle- and pedestrian-specific improvements within their specific jurisdiction.

Policy Considerations for Non-motorized Future Planning Efforts

The following actions represent concerns that were raised through the *Clark County Bicycle and Pedestrian Plan* process, but that were outside of the purview of this plan. These considerations will be addressed in the future as funding permits.

- Provide plans for “20 minute neighborhoods:” circulation plans that provide walking and bicycling routes for residents within 20 minutes of key attractions.
- Study key populations such as the elderly and low-income individuals and use the information to assist in developing pedestrian and bicycle circulation plans.
- Provide pedestrian amenities, such as benches, mid-block crossing pedestrian refuge islands, and pedestrian illumination.
- Provide bicycle and pedestrian amenities, such as street trees and landscaping, and any other amenities that would increase the perceptions of safety for walking and bicycling.
- Conduct a corridor study to identify semi-continuous, safe, predictable pedestrian and bike routes that parallels the I-5 and I-205 corridors.

Plan Organization and Use

The Clark County Bicycle and Pedestrian Master Plan is organized as follows:

- Chapter 1: Introduction provides an overview of this plan and its purpose.
- Chapter 2: Existing Conditions, provides an overview of Clark County’s existing pedestrian, bicycle, and shared-use path network.
- Chapter 3: Recommended Policies presents policies that facilitate development of a bicycle and pedestrian network, jurisdictional



Figure 4. Bicycling is increasing as an activity for active transportation and recreation.

coordination, traffic management, education, encouragement and safety programs, and funding.

- Chapter 4: Recommended Prioritized Network, depicts the recommended system of on-street bikeways and walkways, and off-street shared-use paths.
- Chapter 5: Bicycle Parking Standards and Guidelines, provides an overview of parking design and policy best practices.
- Chapter 6: Design Program, outlines local, state and national best practices for various pedestrian, bicycle, and trail facility types.
- Chapter 7: Education and Outreach Strategies, describes education, encouragement, enforcement and evaluation measures Clark County and/or other local agencies should implement to promote walking and bicycling, increase safety, and increase the awareness of walking and bicycling as viable travel modes.
- Chapter 8: Implementation Plan, identifies potential funding strategies and supporting policies.

Appendices at the end of this document provide additional detailed information as follows:

- Appendix A. Existing Conditions Tables, provides existing conditions for physical infrastructure as well as policies and prioritization guidelines for the individual jurisdictions.
- Appendix B. Prioritization Criteria, outlines the methodology used to identify the recommended network.
- Appendix C. presents information about walk routes to schools.
- Appendix D. County Sidewalk Infill Program outlines the policy used to determine priority for infilling sidewalks in the county.
- Appendix E. Bicycle Planning Maps contains the detailed maps with recommended bicycle, pedestrian and trail projects.
- Appendix F. Rapid Health Impact Assessment, outlines the health impacts of adopting the proposed bicycle and pedestrian plan. The work on the health impact assessment was funded by a grant from the Robert Wood Johnson Foundation.

This page intentionally left blank.

Chapter 2. Existing Conditions

This chapter presents an overview of existing pedestrian and bicycle facilities in Clark County, including sidewalks, intersections, shared-use paths, on-street bicycle facilities, and bicycle parking.

Jurisdictional Responsibilities

Clark County is responsible for the planning, construction, maintenance, operations, rehabilitation, and improvements to rural roadways (excluding state highways), urban roadways outside of incorporated cities, and bridges, as well as planning and maintenance of urban streets. Clark County also develops policies and guidelines for implementing pedestrian and bicycle improvements, which can aid jurisdictions in development of nonmotorized transportation facilities.

Pedestrian Infrastructure Overview

Pedestrian travel is accommodated and enhanced by sidewalks, shared use paths, crosswalks, curb ramps and other infrastructure that provides separated space and enhances visibility for pedestrians.

The County's policy is to construct sidewalks on one side of most streets, although several main streets through areas with pedestrian destinations have sidewalks on both sides, such as NE 99th Street and SW Eaton Boulevard. Other roads outside the centers often do not have sidewalks, such as NE 10th Avenue, NE 19th Street. In rural areas, pedestrian travel commonly occurs along the shoulder of the roadway, which is often unpaved. Walking through rural areas of unincorporated Clark County can be challenging, particularly for pedestrian in wheelchairs, and even where sidewalks exist, proximity to major roads leads to an walking uncomfortable environment.

Existing sidewalk conditions were provided from the following inventories:

- Highway 99 Sidewalk Inventory
- Salmon Creek Sidewalk Inventory
- 2010 Walkway Rankings – 2009 Reported Locations

The existing pedestrian network was also guided by the Clark County Citizen ADA Advisory Committee *ADA Transition Plan* (2006).

Existing sidewalks were not mapped; rather, locations with missing, partial, or obstructed sidewalks were mapped in order to apply the selection criteria and make recommendations.



Figure 5. Many Clark County residents currently walk for transportation and recreation.

Bicycle Infrastructure Overview

The existing bicycle system within Clark County is currently laid out as part of the *Regional Trail and Bikeway Systems Plan*, which was last updated in 2006. In addition, the Highway 99 bike lane inventory identified existing on-road bikeway facilities in the unincorporated areas in urban growth areas.

Bikeways are distinguished as preferential roadways accommodating bicycle travel. Accommodation primarily takes the form of bicycle route designation (signage) and/or bicycle lane striping. Bicycles are permitted on all roads in Clark County, with two exceptions through the Vancouver area: bicycles are not allowed on Interstate 5 from the Colombia River to the junction with Interstate 205 or on Interstate 205 from state line to SR 14 (exit 27).

While dedicated bicycle facilities are not required to accommodate bicycles, the existing traffic speeds and volumes on roads in Clark County often warrant additional separation. While some dedicated cyclists may feel comfortable riding on any street, the majority of people need bike lanes at a minimum to feel comfortable enough to consider bicycling as a viable mode of transportation. While speed and volume data are not available for every road in Clark County, the street typology indicates the bicycling environment and is described in Appendix B: Existing Conditions.

Shoulder Bikeways

Typically found in rural areas, shoulder bikeways are paved roadways with striped shoulders wide enough for bicycle travel (Figure 6). Shoulder bikeways often, but not always, include signage alerting motorists to expect bicycle travel along the roadway. Shoulder bikeways in Clark County exist on portions of SR 500, NE 99th Street, Highway 99, and several others as shown in Table 2.

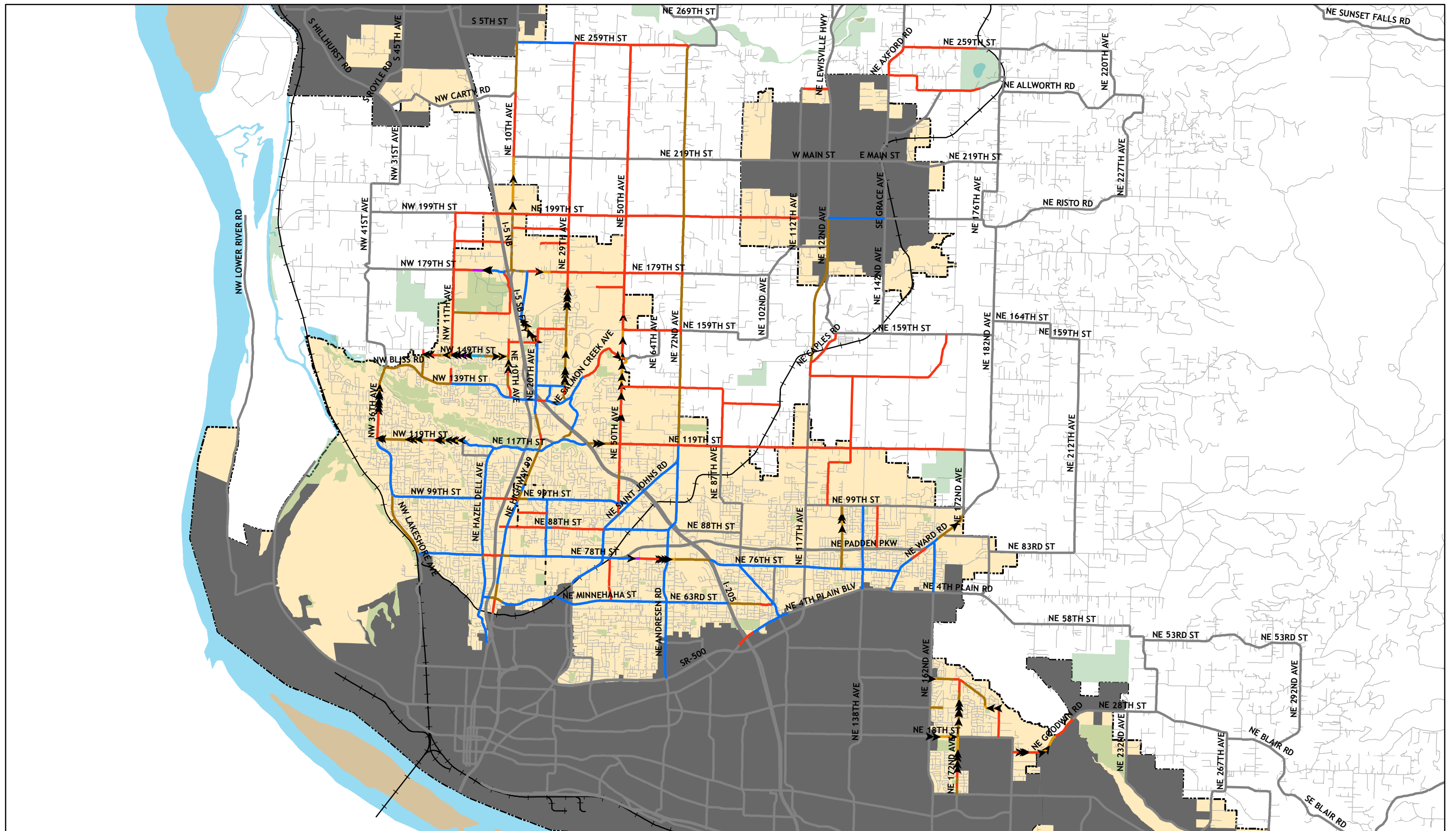

Figure 6. Shoulder bikeways accommodate cycling on rural roads without curbs and gutters.

Table 2. Shoulder Bikeways in Clark County









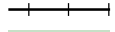

Route	From	To	Length (miles)
NE 10th Ave	NE 259th St	NE Carty Rd	0.89
NE 10th Ave	NE 184th St	NE 179th St	0.31
NE 10th Ave	NE Knowles Dr	S of NE 139th St	0.18
SR 503 (NE 117th Ave)*	Battle Ground city line	NE 149th St	1.53
NE 172nd St	NE 35th St	NE 31st St	0.11
NE 172nd St	NE 22nd St	NE 18th St	0.21

* This portion of SR 503 also has a shared-use path along the east side, which is separated from the highway and is also used by bicyclists.



Map 1: On-Street Bikeways Inventory

Clark County
 Bicycle and Pedestrian Master Plan
 Source: Data obtained from Clark County
 Author: HWK
 Date: April 2010

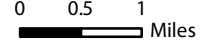
 Full Bike Lane	 Shared Lane	 No or Difficult Bicycle Facilities	 Railroad
 One-Way Bike Lane	 Difficult Shared Lane, Difficult Shared Lane	 Proposed Road	 Parks
 Shared Lane/Bike Lane	 One-Way Shared Lane	 Urban Growth Boundary	 0 0.5 1 Miles



This page intentionally left blank.

Shoulder Bikeways in Clark County (continued)

Route	From	To	Length (miles)
NE 28th St	NE 162nd Ave	NE 166th Pl	0.23
NE 29th Ave	NE 166th St	NE 53rd Cir	0.70
NE 29th Ave	NE 150th St	NE 145th St	0.22
NE 39th St	NE 164th Ave	NE 169th St	0.28
NE 50th Ave	NE 159th St	S of NE 159th St	0.22
NE 50th Ave	NE 137th St	NE 135th St	0.09
NE 63rd St	I-205	NE 102nd Ave	0.55
NE 72nd Ave	NE 259th St	NE 119th St	6.98
NE 78th St	NE Hwy 99	NE 13th Ave	0.14
NE 78th St	NE 72nd Ave	I-205	0.61
NE 78th St	I-5 ramp	NE 13th Ave	0.20
NE 99th St	NE Hwy 99	NE 19th Av	0.18
NE Edmunds Rd	NE 174th Ct	NE 29th St	0.57
NE Hazel Dell Ave	NW 78th St	NE 77th St	0.05
NE Highway 99	NE 129th St	NE 122nd St	0.34
NE Highway 99	NE 68th St	NE Minnehaha St	0.25
NE Hwy 99	NE 119th St	NW 104th St	0.85
NE Hwy 99	NE 102nd St	NE 15th Ave	0.21
NE Minnehaha St	I-5	NE 11th Ave	0.27
NE Salmon Creek Ave	NE 125th St	NE 117th St	0.45
NE Ward Rd	NE 162nd St	City Line	0.13
NE Ward Rd	NE 162nd Ave	NE 162nd Ave	0.09
NW 119th St	NW 36th Ave	NW 21st Ave	0.75
NW 119th St	NW 16th Ave	NW 7th Ave	0.50
NW 149th St	W of NE 2nd Ave	NE 5th Cir	0.19
NW 149th St	NW 16th Ave	NW 11th Ave	0.26
NW 164th St	NW 11th Ave	Vancouver city line	0.44
NW 21st Ave	NE 149th St	NW Bliss Rd	0.37
NW 36th Ave	NW Bliss Rd	NW 138th St	0.33
NW Bliss Rd/NW Hathaway Rd/NW 139th St	NW Seward Rd	NW 11th Ave	1.26
NW Lakeshore Ave	NW 99th St	NW 78th St	1.17
NE 130th Ave	NE 89th St	NE 78th St	0.67
SR 502 (NE 219 th St)	E of NE 10 th Ave	Battle Ground	0.47
SR 503 (NE Lewisville Hwy)	NE 318 th St	NE 269 th St	2.84
Total Existing Shoulder Bikeways			26.08

Bicycle Lanes

Designated exclusively for bicycle travel, bicycle lanes are separated from vehicle travel lanes with striping and also include pavement stencils (Figure 7). Bicycle lanes are most appropriate on arterial and collector streets in both urban and rural areas where higher traffic volumes and speeds warrant greater separation. Bike lanes help to define the road space for bicyclists and motorists, reduce the chance that motorists will stray into the cyclists' path, discourage bicyclists from riding on the sidewalk, and remind motorists that cyclists have a right to the road. There are 43 miles of existing bike lanes in Clark County, as shown in Table 2.



Figure 7. Bike lanes provide separated roadway space for cyclists.

Table 3 Existing Bike Lanes in Clark County

Route	From	To	Length (miles)
NE 117 th St	NW 7th Ave	NE Hazel Dell Ave	0.58
NE 119th St	NE Hazel Dell Ave	I-205 NB	1.71
NE 134th St	NE 23rd Ave	NE Salmon Creek Ave	0.47
NE 137th Ave	NE 99th St	NE 4th Plain Blvd	1.45
NE 139th St	NE 20th Ave	NE 29th Ave	0.50
NE 139th St/NE Tenney Rd/ NE 134th St	NW 11th Ave	NE 20th Ave	1.59
NE 15th Ave	NE 179th St	NE Union Rd	0.88
NE 162nd Ave	NE Ward Rd	NE 4th Plain Rd	0.87
NE 179th St	NE 10th Ave	W of I-5	0.28
NE 20th Ave	NE 154th St	NE 129th St	1.25
NE 23rd Ave	NE 139th St	NE 134th St	0.28
NE 259th St	NE 10th Ave	NE 41st Ave	0.99
NE 25th Ave	NE 99th St	NE 78th St	1.00
NE 4th Plain Blvd	NE 54th St	NE 112th Ave	0.70
NE 72nd Ave	NE 119th St	SR-500	4.15
NE 76th St	I-204	NE Ward Rd	3.32
NE 78th St	NE 13th Ave	NE 58th Ave	2.27
NE 88th St	NE 25th Ave	NE 26th Ave	0.09
NE 88th St	St. Johns Rd	NE Andresen Rd	1.13
NE 99th St	NE 19th Ave	NE St. Johns Rd	1.77
NE Covington Rd/NE 107th Ave	NE 63rd St/NE 76th St	NE 4th Plain Blvd	1.18
NE Hazel Dell Ave	NE 119 th St	NW 99 th	0.96
NE Hazel Dell Ave	NW 99th St	NE 78th St	0.99
NE Hazel Dell Ave	NE 77th St	Vancouver City Line	1.42
NE Highway 99	NE 15th Ave	NE 68th St	1.49
NE Hwy 99	NE 104th St	NW 102nd St	0.11
NE Minnehaha St	NE 11th Ave	Vancouver City Line	0.92

Route	From	To	Length (miles)
NE Minnehaha St	NE Hazel Dell Ave	I-5	0.11
NE Minnehaha St/NE 63rd St	NE Saint Johns Rd	I-205	2.76
NE Saint Johns Rd	NE 50th Ave	NE 72nd Ave	1.37
NE Saint Johns Rd	NE 68th St	NE 78th St	0.71
NE Salmon Creek Ave	NE Betts Rd	I-205	0.45
NE Ward Rd	NE 162nd Ave	NE 4th Plain Rd	1.17
NW 78th St	NW Bacon Rd	NW 8th Ave	0.64
NW 78th St	W of NW Anderson Ave	NE Hazel Dell Ave	0.43
NW 99th St	NW Lakeshore St	NW 9th Ave	1.60
NW Lakeshore Ave	NE 119th St	NW 99th St	1.06
Total Existing Bike Lanes			42.66



Figure 8. Shared lane markings are used to indicate a bicycle route, and to show cyclists where they should be riding in the road.

Shared Roadways

The most common type of bikeway, shared roadways accommodate vehicles and bicycles in the same travel lane. The most suitable roadways for shared vehicle/bicycle use are those with low posted speeds (25 MPH) or low traffic volumes (3,000 ADT or less). Curb-to-curb widths range between 40' and 50' and the typical street cross-section includes two vehicle travel lanes with on-street parking.

Most of the County's local streets and many neighborhood circulator streets can be classified as shared roadways, as they accommodate bicyclists without the need for separated bicycle facilities (e.g., bicycle lanes). Shared lane marking treatments, also called "sharrows," benefit cyclists by improving visibility (Figure 8).

Trails and Connections

Pathways (also referred to as "trails," "multi-use paths," and shared-use paths) are used by pedestrians, cyclists, in-line skaters, and runners. Pathways are typically paved (asphalt or concrete) but may also consist of an unpaved smooth surface that meets county standards.

In general, pathways are desirable for slower-speed recreational cycling, particularly by families and children. They are also used extensively by commuters for at least part of their commute within Clark County. Every jurisdiction within Clark County has at least one pathway as shown in the Vancouver-Clark Parks Department's Trails of Clark County Map.



Figure 9. The path along SR 503 receives heavy use from bicyclists and pedestrians alike.

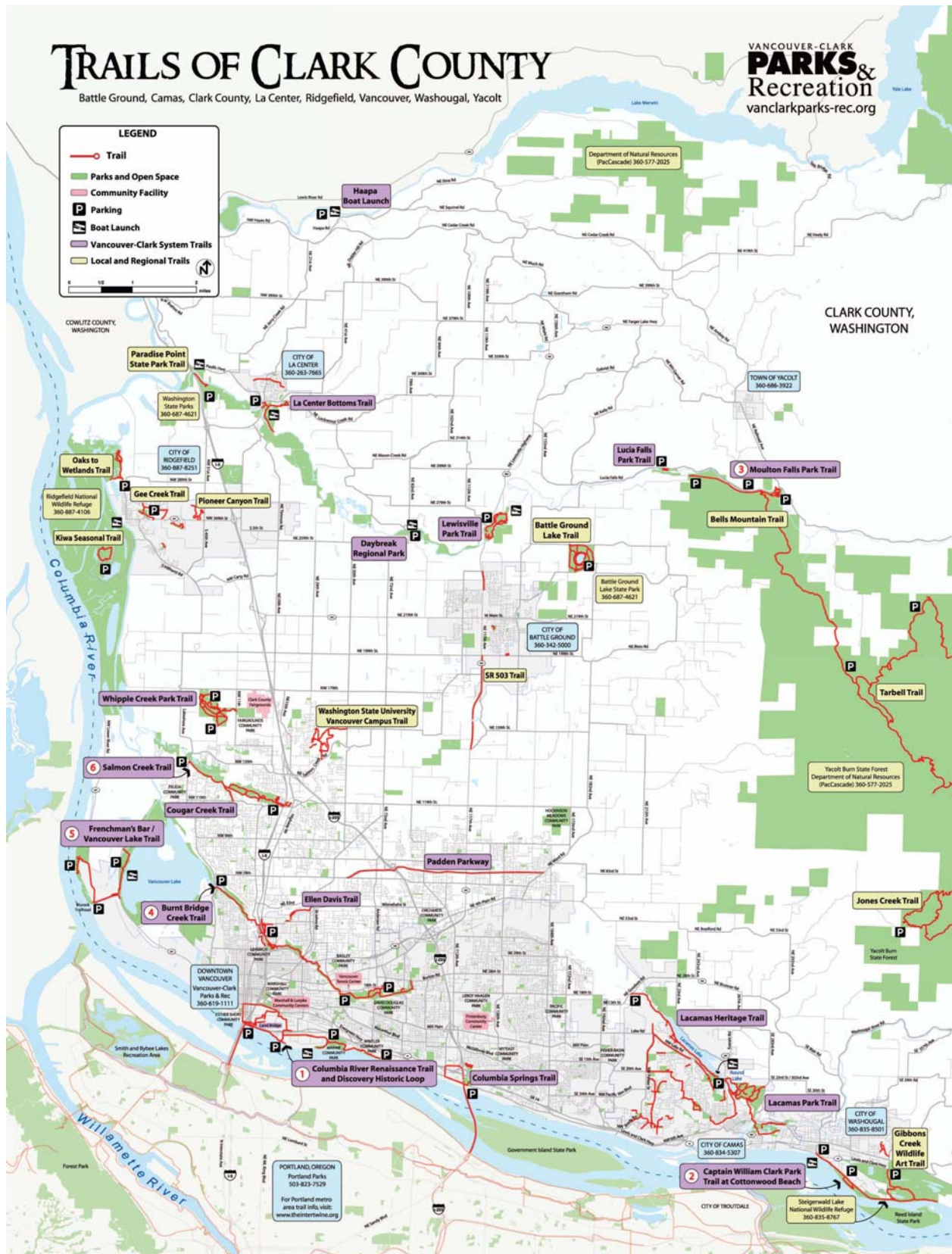



Figure 10. 'Share the Road' signage can be used along roadways to indicate preferred cycling routes.

While pathways are important to the overall circulation network for non-motorized transportation, the focus of this plan is the on-street network. Using the 2006 adopted *Clark County Trails and Bikeway System Plan*, the *Clark County Bicycle and Pedestrian Master Plan* identifies where new on-street bicycle and pedestrian facilities can connect and leverage with existing and proposed trails.

Signage

Implementing a well-designed, attractive, and functional system of network signage greatly enhances bikeway facilities by promoting their presence to both potential and existing users. Clark County currently indicates bicycle routes through the use of 'Bike Lane' signs (MUTCD sign R3-17) and 'Share the Road' signs (W16-1) with a bicycle sign (W11-1; see Figure 10).

End of Trip Facilities

End of trip facilities include a reasonably secure location and appropriate type of bicycle parking, as well as a location to change from bicycling clothing into to work appropriate clothing.

Bike Racks (Short-Term)

Short-term bicycle parking facilities are best used to accommodate bicycles of visitors, customers, messengers, and others expected to depart within two hours. This parking is provided by bicycle racks, which provide support for the bicycle but do not have locking mechanisms. Within Clark County, bike racks are frequently located at schools, commercial locations, and activity centers such as parks, libraries, and other retail locations.

Bike Lockers (Long Term)

Long-term bicycle parking facilities accommodate bicycles of employees, students, residents, and others expected to park more than two hours. This parking is provided in a secure, weather-protected manner and location, such as a bicycle locker or a secure area like a 'bike corral' that may be accessed only by bicyclists.

According to the Southwest Washington RTC MTP (2008), C-TRAN also provides bicycle lockers and/or racks facilities at Fisher's Landing, 99th Street, and Vancouver Mill Transit Centers. In addition, the Battle Ground, Evergreen and Salmon Creek Park-and-Ride facilities have bicycle lockers or racks. Existing CTRAN bicycle parking facilities in Vancouver are listed in Table 4.

Table 4. CTRAN Bicycle Parking Inventory

Location	Bike Locker ^{*4}	Bike Bank	Bike Rack
Administrative Offices	4	2	2
BPA Park & Ride	N/A	2	N/A
Camas (Burgerville)	2	N/A	N/A
Evergreen Park & Ride	4	8	1
Fisher's Landing Transit Center	6	N/A	2
99 th Street Transit Center	12	N/A	1
Salmon Creek Park & Ride	6	4	1
Vancouver City Center	5	9	N/A
Vancouver Mall Transit Center	6	6	N/A

* Each bike locker has a capacity for two bicycles.

Changing Facilities

Other end-of-trip facilities for bicyclists include changing areas, clothes lockers, and showers, which allow bicyclists to clean up after riding. These facilities are often located at places of employment, so that an employee can bicycle in, then shower and change before starting work. Shower and locker facilities may exist in some office buildings and other employment centers in Clark County, but they do not appear to be very common. Health and fitness clubs can offer an alternative place to shower/change for commuter cyclists, but only function for commuter cyclists if the facilities are located conveniently close to the place of employment.

Multi-Modal Connections

Southwest Washington Regional Transportation Council is the regional transportation planning authority for Clark County. C-TRAN is the local transit authority and is based in Vancouver Washington and offers the following public transportation services:

- Bus service includes 18 routes operating in Clark County
- Seven Express commuter routes into downtown Portland
- Four Limited routes with service to downtown Vancouver and MAX light rail
- Three reservation-based Connector routes serving Camas, Ridgefield and La Center



Figure 11. Pedestrians and bicyclists of all ages and abilities benefit from a comprehensive system of off-road paths.

All buses are equipped with a bicycle rack on the front of the bus that will hold two bikes. Bicycles are allowed in the bus at the discretion of the driver, if there is room in the front. Map 3 shows the existing transit service in Clark County provided by C-TRAN.

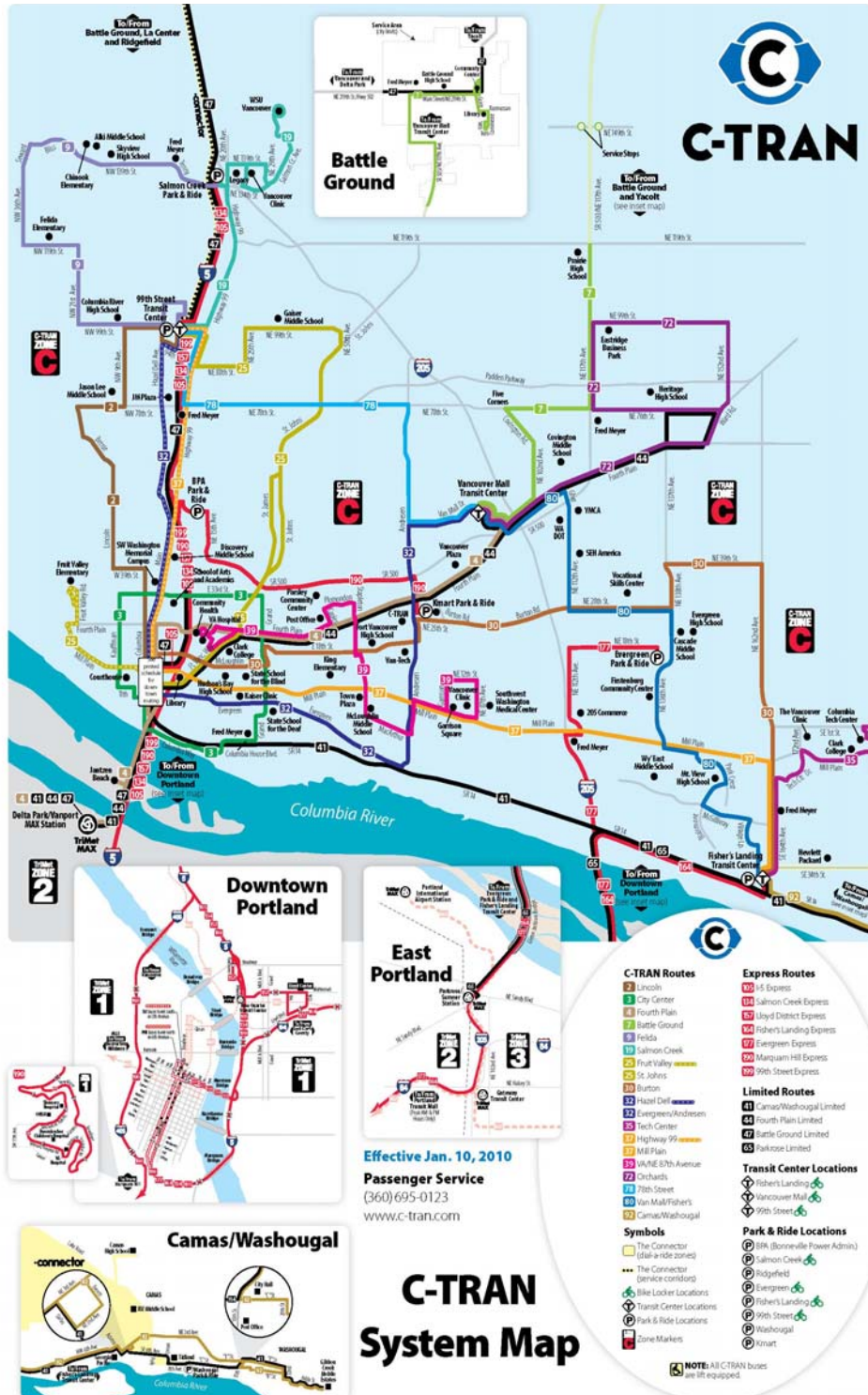

Map 3. Existing Transit Service in Clark County (map from C-TRAN)

This page intentionally left blank.

Chapter 3. Recommended Policies



Figure 12. Bicyclists enjoying a scenic trail.

This chapter lays out a vision of how to continue and expand improvements to increase and promote walking and bicycling in Clark County. The recommended goals, objectives and actions provided below are based on existing policies relevant to pedestrian and bicycle travel from previously adopted plans in Clark County and the individual jurisdictions, and will be adopted into the County's Comprehensive Plan when it is updated in 2014.

The objectives and actions are designed to guide the way the public improvements are made, where resources are allocated, how programs are operated, how department priorities are determined, and how private development is designed. Policies are organized into the categories of:

- Developing a Bicycle and Pedestrian Network
- Jurisdictional Coordination
- Traffic Management/Demand Management
- Education, Encouragement and Safety Programs
- Funding
- Bicycle- and Pedestrian-Supportive Land Uses

The policies proposed here are not proscriptive and have no fees or specific penalties associated with noncompliance. County level policies do not take the place of individual City bicycle and pedestrian policies. Rather, they should augment the policies of each city and provide appropriate county-level support for cycling and walking.

Goal 1. Developing a Bicycle and Pedestrian Network

Objective 1.1 Implement the Clark County Bicycle and Pedestrian Master Plan to expand travel opportunities for transportation and recreation.

Action 1.1.1 Complete the recommended bikeway and walkway network by closing existing gaps and considering innovative design solutions for constrained locations to provide accessible bicycling and walking corridors throughout Clark County.

Action 1.1.2 Install signage along all local and regional bikeways to assist with wayfinding and to increase awareness of bicyclists.

Action 1.1.3 Integrate bicycle and pedestrian facilities into new construction and reconstruction (including overlays) of roadway projects where bikeways have been designated, using optimum designs and practices.

- Action 1.1.4 Provide technical assistance and encouragement to local jurisdictions to implement local bicycle and pedestrian plans and projects.
 - Action 1.1.5 Design a variety of bikeway facility types that provide transportation and recreation opportunities for all levels of cyclists with a focus on meeting the needs of inexperienced cyclists.
 - Action 1.1.6 Include health and equity in bicycle and pedestrian project prioritization criteria.
- Objective 1.2 Identify county-wide networks of bicycle and pedestrian facilities that augment local networks identified by each city.
- Action 1.2.1 Implement a continuous network of bike lanes, bicycle boulevards, and bike routes that are integrated with current and future trails that support bicycle use and that serve commuting, recreation, and utilitarian trips.
 - Action 1.2.2 Provide safe and accessible bicycle and pedestrian facilities that link with local and regional community centers (downtowns, schools, parks, neighborhood centers) and pathway systems, as well as regional facilities and destinations.
 - Action 1.2.3 Implement a continuous network of sidewalks, pedestrian pathways and shared use facilities that serve all pedestrian user groups, including commuting, recreation and utilitarian trips.
 - Action 1.2.4 Provide sidewalks on both sides of streets that are within activity centers, as identified as high-priority projects in this Plan.
 - Action 1.2.5 Complete the recommended bikeway and pedestrian networks by closing existing gaps and by integrating innovative design solutions for constrained locations to provide accessible bicycling corridors – when appropriate - throughout Clark County.
 - Action 1.2.6 Provide adequate bicycle and pedestrian facilities on county bridges, especially those that pass through urban areas.
- Objective 1.3 Encourage large employers, developers, and other organizations to provide secure short- and long-term bicycle parking in employment and commercial areas, in



Figure 13. Shared-use trails are used by all types of cyclists, for all types of trips.

multifamily housing, at schools, and at transit facilities, including covered and/or attended parking.

- Action 1.3.1 Develop bicycle parking standards and minimum quantities of short-term and long-term bicycle parking tied to land uses.
- Action 1.3.2 Incentivize the development of bicycle parking by offering reduced automobile parking minimums for developments that include bicycle parking.
- Objective 1.4 Increase the number of bicycle-transit trips and pedestrian access to transit.
 - Action 1.4.1 Provide on-street bicycle and pedestrian connections to transit centers and bus stops.
- Objective 1.5 Develop and improve trails within parks.
 - Action 1.5.1 Provide on-street bicycle and pedestrian connections to trails in parks.
 - Action 1.5.2 Change Title 40 to include a Park Code which guides development standards for parks and provides specific development guidelines supporting trail construction.

Goal 2. Jurisdictional Coordination

- Objective 2.1 Facilitate coordination and cooperation among local jurisdictions in development of the bikeways and pedestrian facility recommendations.
 - Action 2.1.1 Develop recommendations that provide Clark County community partners and local agencies the tools and guidance necessary to implement bicycle- and pedestrian- specific improvements within their specific jurisdiction.
 - Action 2.1.2 Establish and maintain regular communications between Clark County, constituent cities, Clark County Bicycle and Pedestrian Advisory Committee, CTRAN, Friends of Clark County-Active Transportation Committee, Vancouver-Clark Parks Department, Southwest Washington Regional Transportation Council (RTC), Washington State Department of Transportation and other affected agencies, and other affected agencies regarding bicycle and pedestrian planning issues.



Figure 14. Dog walking along the Padden Parkway Trail.

- Action 2.1.3 Work with jurisdictions to identify bicycle and pedestrian routes throughout the county, and ensure that they connect with city facilities.

Goal 3. Traffic Management/Demand Management

Objective 3.1. Encourage use of alternative types of transportation, particularly those that reduce mobile emissions (bicycle, walking, carpools, and public transit) by implementing Transportation Demand Management Strategies aimed at reducing the number of drive alone trips.

- Action 3.1.1 Publicize the availability of bicycling and pedestrian maps and other bicycling resources as well as connections to public transit through the Clark County website, bicycle shops, schools, employers, and other locations.

Objective 3.2 Ensure bicycle and pedestrian facilities are designed to the most recent federal, state and local design guidelines and best practices.

- Action 3.2.1 Ensure compliance with the Americans with Disabilities Act (ADA).
- Action 3.2.2 Support excellence among staff by ensuring exposure to innovative, tested new designs, such as those documented by the National Association of City Transportation Officials Cities for Cycling project.¹
- Action 3.2.3 Develop and implement a county-wide training program to educate engineers, planners, and public decision-makers about the needs of bicyclists and pedestrians.

Goal 4. Education, Encouragement and Safety Programs

Objective 4.1 Promote bicycle and pedestrian safety and increased bicycling and walking through education and encouragement activities.

- Action 4.1.1 Continue existing and pursue new adult and youth bicycle and pedestrian education and safety programs, such as workshops on bicycle commuting and pedestrian safety.

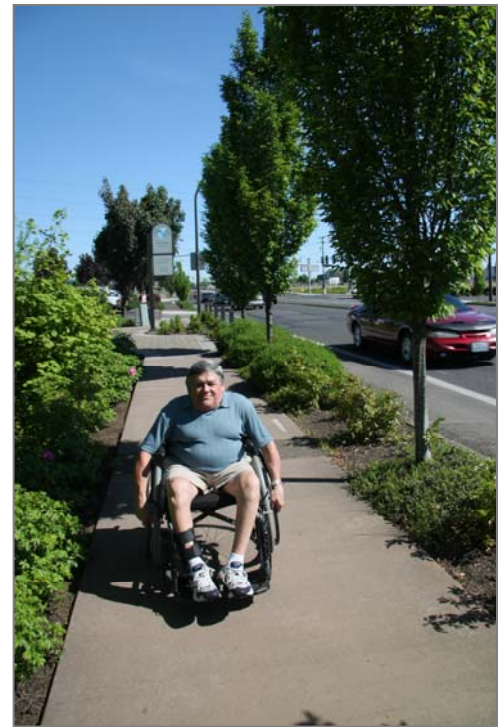

Figure 15. Sidewalks and intersections should be designed to the most recent state and federal accessibility standards.

¹ www.nacto.org/citiesforcycling.html

- Action 4.1.2 Collaborate with schools to utilize federal and state transportation funds to provide walking facilities near schools and support educational and incentive programs to encourage more students to bicycle or walk to school.
- Action 4.1.3 Include temporary street closures (ciclovias) as an encouragement program proposal.
- Objective 4.2 Promote increased bicycling and walking for transportation.
 - Action 4.2.1 Encourage employers to provide incentives and support facilities for employees that commute by walking or bicycling
 - Action 4.2.2 Encourage jurisdictions to provide incentives to businesses and residents completing new and re-development of properties that include bicycle- and pedestrian-friendly facilities and design.
- Objective 4.3 Promote bicycle and pedestrian safety and increased bicycling and walking through enforcement activities.
 - Action 4.3.1 Establish and maintain stricter law enforcement of traffic violations by all parties, particularly in high activity zones (urban areas, intersections, near schools and universities, along popular bicycling routes, etc.), and emphasize positive enforcement for safe bicycling and walking behavior by children.
 - Action 4.3.2 Recognize increasing numbers of cyclists and pedestrians as a safety strategy.
- Objective 4.4 Maintain and improve the quality, operation, and integrity of bikeway and walkway network facilities.
 - Action 4.4.1 Develop and implement a bikeway and walkway maintenance program, including sweeping, pot hole repair, and hazard removal along bicycle routes and sidewalks, as funding and priorities allow.
 - Action 4.4.2 Install continuous counting devices to track ridership goals.
 - Action 4.4.3 Establish policies and protocols to ensure that repair and construction of transportation facilities minimizes disruption to the cycling and walking environment to the extent practical.



Figure 16. Children can learn bicycle safety from an early age

- Action 4.4.4 Use available crash data to monitor bicycle- and pedestrian-related crash levels related to public transportation or public activities/exercise annually, and target a 10 percent reduction on a per capita basis over the next twenty (20) years.

Goal 5. Funding

- Objective 5.1 Work to fund construction of the bicycle and pedestrian improvements in this Plan and maximize the amount of local, state, and federal funding for bikeway and walkway facilities that can be received by agencies in Clark County.
 - Action 5.1.1 Seek funding for bicycle and pedestrian transportation projects through current local, regional, state, and federal funding programs while seeking to form local partnerships to leverage those funds to maximize the use of available dollars.
 - Action 5.1.2 Include cost of short-term projects in Clark County's Capital Improvement Plan to prioritize future funding.
 - Action 5.1.3 Aggressively pursue grants to fund the top-priority bicycle and pedestrian projects.
 - Action 5.1.4 Maintain current information regarding regional, state, and federal funding programs for bikeway, walkway, and trail facilities along with specific funding requirements and deadlines.
 - Action 5.1.5 Partner with other agencies to pursue funding for bicycle and pedestrian projects as stand-alone grant applications or as part of larger transportation improvements.
 - Action 5.1.6 Coordinate with all jurisdictions in development of the transportation benefit district to create a source of funding for stand-alone bicycle and pedestrian projects.
- Objective 5.2 Pursue voluntary and private funding sources for bicycle improvements.
 - Action 5.2.1 The newly-created Bicycle and Pedestrian Advisory Committee will pursue options for implementing a voluntary fund.



Figure 17. The Pacific Community Park trail provides a buffer from NE 17nd Ave.

Action 5.2.2 The Bicycle and Pedestrian Advisory Committee will work to develop partnerships with the private sector to promote this fund.

Goal 6. Active Transportation Planning and Bicycle- and Pedestrian-Supportive Land Uses

Objective 6.1 Increase development practices that are supportive of walking and cycling.

Action 6.1.1 Ensure consistent review of road projects & development proposals in the planning stage by the Bicycle and Pedestrian Advisory Committee.

Action 6.1.2 Include low-speed roadway designs as bicycle and pedestrian projects.

Action 6.1.3 Prioritize projects and adopt policies that increase measures of walkability.

Action 6.1.4 Change title 40 and/or road standards to limit the construction of new cul-de-sacs and connect existing cul-de-sacs with bicycle and/or pedestrian accessways.

Action 6.1.4 Change title 40 and/or road standards to promote pedestrian- and bicycle-friendly design through human-scale development and providing comfortable and attractive places.

Action 6.1.5 Change title 40 and/or road standards to encourage a dense mix of uses and higher-density residential land uses that include provisions for sidewalk and bicycle routes.

Objective 6.2 Improve bicycle and pedestrian access to nutritious food.

Action 6.2.1 Prioritize bicycle and pedestrian improvements that provide routes to grocery stores and farmers’ markets.

Action 6.2.2 Encourage grocery stores and farmers’ markets to locate along existing bicycle and pedestrian corridors.



Figure 18. Pacific Park and 18th Street frontage.

This page intentionally left blank.

Chapter 4. Recommended Prioritized Network

As discussed in Chapter 2, Clark County has many existing bicycle and pedestrian facilities; however the networks are not complete throughout the county and are often discontinuous. A sidewalk with a gap or without a curb ramp can be inaccessible for a pedestrian in a wheelchair, while a bike lane that ends suddenly can be uncomfortable and challenging for cyclists. Furthermore, several major roads act as barriers to bicycle and pedestrian travel in Clark County; in addition to the interstates, Highways 14, 99, 500, 501, 503, and 509 are multi-lane, fast-moving corridors where limited crossings are provided.

This Plan focuses recommendations on walkways, bikeways, and trails that connect key destinations in and around Clark County. Recommendations are designed to overcome the barriers, providing access where destinations are separated by major highways and thoroughfares. In many of these areas, residents and visitors have no choice but to drive to every destination. These recommendations provide expanded options for transportation and recreation.

The Three Creeks Special Planning Area is made up of the unincorporated urban areas around Hazel Dell, Felida, Lake Shore, Salmon Creek and the fairgrounds and benefits from many pedestrian and bicyclist destinations, but also has many major roads that bar nonmotorized travel. Many of the recommendations in this Plan focus on that area.

Projects have been ranked so that the high-priority projects will substantially improve the bicycling and walking environment within the first five years of plan implementation. The top ten projects from each category that are unlikely to occur as part of a development project were selected as short-term projects to focus implementation on projects that have the highest capacity to improve walking and bicycling. Other projects should occur with road construction or other development projects, or when funding becomes available. The sidewalk project list is not a comprehensive list of all sidewalk gaps in the County; the data is not currently available county-wide, but the sidewalk lists will be updated as sidewalk inventories are completed throughout the county. Pedestrian and bicycle facility design will be subject to relevant design guidelines (e.g. Washington DOT) and also depending on their location.

Many constraints impede the construction of bicycle and pedestrian facilities; topography, right-of-way availability, presence of utilities, traffic and safety issues are among the barriers to development of the bicycle and



Figure 19. The Padden Parkway Trail provides significant connectivity for bicyclists and pedestrians.

pedestrian network. These issues apply to county facilities, as well as state facilities. These concerns can be addressed by implementing bicycle and pedestrian improvements in conjunction with other roadway resurfacing or construction projects. Sidewalks can also be required as part of development applications.

Project Prioritization

The Clark County Bicycle and Pedestrian Master Plan focuses implementation efforts where they will provide the greatest community benefit. While all projects represent important steps for improving Clark County's bicycle and pedestrian environment, limited financial resources require a prioritization mechanism.

The prioritization criteria are shown in Table 5. The criteria were applied to bicycle, pedestrian, and trail projects in the same way. Project prioritization methodology is provided in Appendix B. Projects received a score out of 100 and were subsequently divided into 'High Priority' (score over 50 points) and 'Low Priority' (score below 50 points). The top-10 recommended improvements in each category were the highest-scoring projects for sidewalks, on-street bicycle facilities, and trails.

Table 5. Prioritization Criteria

Criteria	Comments
Closing Gaps	To what degree does the project fill a missing gap or overcome a barrier in the current system? Does it improve significant crossings?
Safety & Comfort	Can the project improve walking and bicycling conditions at locations with perceived or documented safety issues? Does the project make cycling and walking appealing to all users?
Access & Mobility/Land Use	How many user generators does the project connect within a reasonable walking or cycling distance? Are adjacent land uses supportive of walking and bicycling? To what degree will the project generate users?
Multi-modal Connections	To what degree does the project integrate walking and cycling into the existing transit system? Does the project enable the use of multiple active transportation modes?
Implementation	What is the ease of implementation? Is funding available? Is additional right-of-way required? Are negotiations required over parking availability, signage, etc.?
Community Benefit	To what degree does the project offer potential benefits to the regional community by offering opportunities for increased connectivity to parks, natural scenic beauty, and activity centers?
Health Outcomes	To what extent does the project increase physical activity, regardless of travel purpose? To what extent does the project improve other determinants of health?

The Project Team evaluated almost 300 project ideas originating from previous local and regional planning efforts, the bicycle and sidewalk inventories, resident input at community workshops, and other sources. Map 4 shows the top-tier proposed projects.

Recommended Walkway Improvements

Sidewalk projects considered in this analysis include projects from the following inventories:

- Highway 99 Sidewalk Inventory
- Salmon Creek Sidewalk Inventory
- 2010 Walkway Rankings – 2009 Reported Locations

Sidewalks not considered in this analysis include:

- Sidewalk gaps in areas that do not have completed sidewalk inventories
- Sidewalks that would be provided by developers as an area is built out
- County funded roadway projects with sidewalks
- Proposed sidewalks on cul-de-sac streets

As the Clark County Bicycle and Pedestrian Plan covers the entire county, the recommended pedestrian network focuses on pedestrian improvements within unincorporated Clark County. While many of the potential improvements benefitting pedestrians fall under the individual cities' jurisdictions, the recommendations focus on how Clark County can support their actions while providing appropriate regional connectivity.

The sidewalk list is incomplete because several areas in the county have not inventoried sidewalk gaps. As the sidewalk inventory of the county is completed, projects will be added to this list. In addition to the corridor recommendations recommended in Table 6 Clark County should focus pedestrian improvements on providing ADA-accessible curb extensions and providing traffic calming.

Table 6 lists the top ten sidewalk projects that were identified through the prioritization analysis. Map 4 shows the project locations, while Table 7 following outlines key connections each of these projects provides.

Table 6. Priority Identified Sidewalk Projects*

Street	From - To	Length (miles)	Closing Gaps	Land Uses	Safety and Comfort	Community Benefits	Implementation	Multi-Modal	Health Outcomes	Planning-Level Cost Estimate [†]
Hazel Dell Ave	NE 105 th Ave - NE 102 nd St	0.12	25	4	6	1	4	15	15	\$57,000
NE 142 nd Ave	Little Prairie Park - NE 76 th St	0.09	25	10	8	10	4	15	10	\$43,000
NW 119 th St [‡]	NW 36 th Ave - NW 38 th Ave	0.23	25	4	6	4	4	15	15	\$110,000
NE 19 th Ave/ /NE 107 th St	NE 104 th St – Hwy 99	0.16	25	10	12	4	4	15	10	\$76,000
NE 21 st Ave	NE 91 st St - NE 86 th Cit	0.24	25	10	8	8	4	15	10	\$115,000
NE 50 th Ave	NE 99 th St - NE 109 th St	0.54	25	10	6	8	4	15	10	\$258,000
NE 58 th Av	NE 78 th St – NE 69 th St	0.44	25	10	6	10	4	15	12	\$210,000
NE Parkview Dr/ NE 113 th St	NE Hwy 99 - NE 30 th Ave	0.51	25	10	12	4	4	15	10	\$244,000
NW 21 st Ave	NW 111 th St - NW 101 st St	0.47	18	7	6	8	4	15	15	\$4225,000
NW 68 th St	NW 3 rd Ave - Hazel Dell Ave	0.25	25	10	6	8	4	15	10	\$119,000
Total Sidewalk Projects		3.05								\$1,457,000

* Note that these projects do not represent the most important sidewalk projects county-wide; rather, they are the previously-inventoried projects that received the highest scoring based on the criteria outlined in Appendix C.

[†] Sidewalk cost estimates include standard concrete curb and gutter, 6' sidewalk, 12" storm sewer pipe (10' deep), storm manhole, and standard catch basin, as well as a proportion for engineering/construction, mobilization, A and E fees, and contingency. Assumes sidewalk on one side of street only.

[‡] To be constructed after pending development.

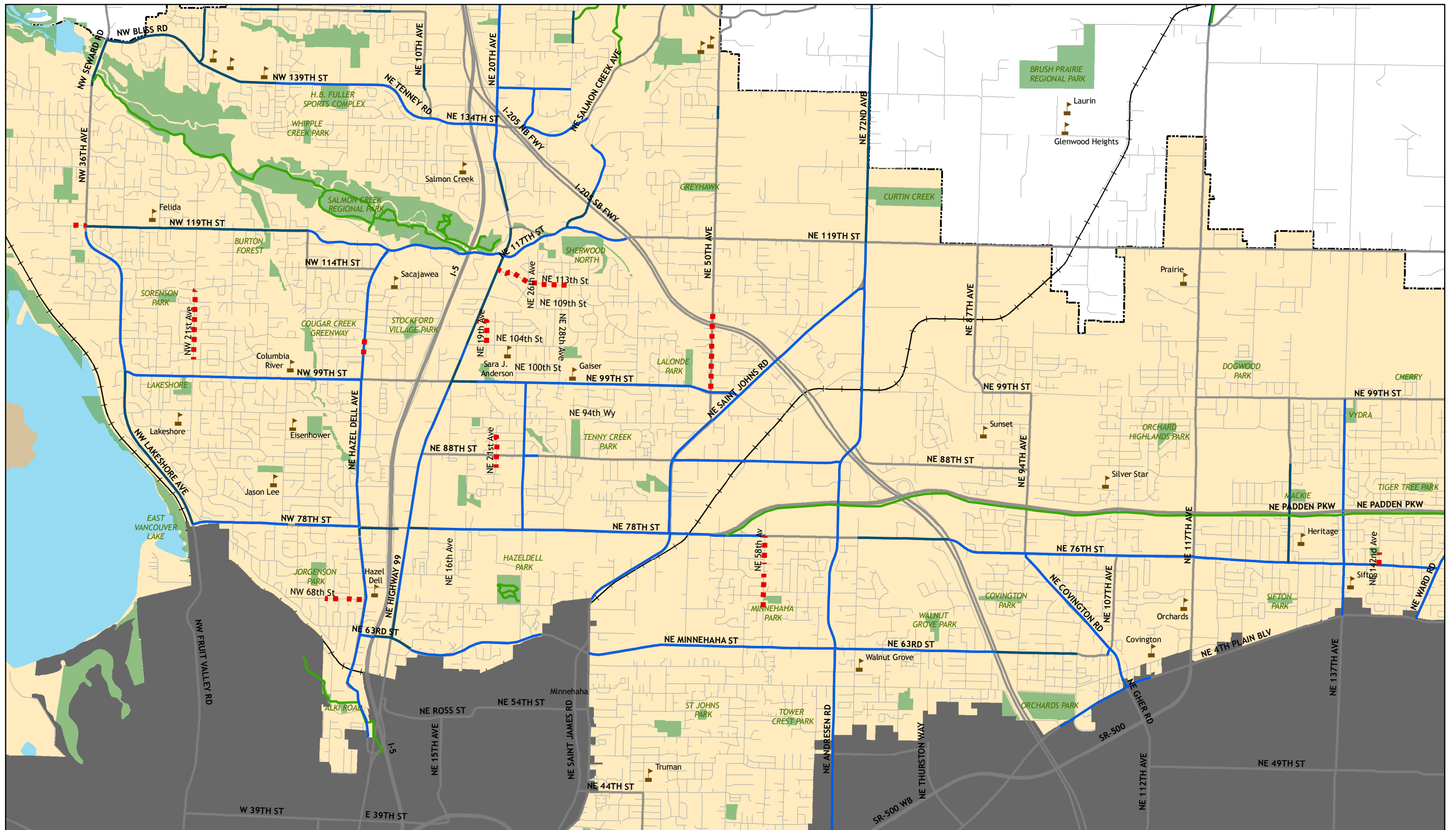

Map 4. Priority Sidewalk Projects

Clark County
 Bicycle and Pedestrian Master Plan
 Source: Data obtained from Clark County
 Author: HWK
 Date: September 2010

- ■ ■ Priority Sidewalk Projects
- Off-Street Trail
- Shoulder Bikeway
- Bike Lane
- Railroad
- Parks
- ▲ School
- Urban Growth Boundary



0 0.25 0.5
 Miles

This page intentionally left blank.

Table 7. Priority Sidewalk Project Connections

Street	From - To	Schools	Parks	Transit	Other
Hazel Dell Ave	NE 105 th Ave to NE 102nd St	<ul style="list-style-type: none"> • Columbia River • Heritage High • Sifton Elem 	<ul style="list-style-type: none"> • Cougar Creek Greenway • Stockford Village Park • Little Prairie Park • Felida Park • Erickson Park • Tenney Creek Park • Open space • Lalonde Park • Minnehaha Park • Salmon Creek Park • Sorenson Park • Lakeshore Park • Jorgenson Park 	<ul style="list-style-type: none"> • NW 99th St • Hazel Dell Ave • NE 76th St • Hwy 99 • NE 88th St • NE 99th St • NE 78th St • Hwy 99 • NW 21st Ave • Hazel Dell Ave 	<ul style="list-style-type: none"> • Will connect to sidewalk constructed by developer • I-205 crossing • Few alternative streets • Vancouver
NE 142nd Ave	Little Prairie Park - NE 76th St				
NW 119th St*	NW 38th – NE 36 th Ave	<ul style="list-style-type: none"> • Felida Elem 			
NE 19th Ave/NE 107 th St	NE 104th St – Hwy 99	<ul style="list-style-type: none"> • Sara J. Anderson Elem 			
NE 21st Ave	NE 91st St - NE 86th Cit				
NE 50th Ave	NE 99th St - NE 109th St	<ul style="list-style-type: none"> • Gaiser Jr. High 			
NE 58th Av	NE 78th St – NE 69 th St				
NE Parkview Dr/ NE 113th St	NE Hwy 99 - NE 30th Ave				
NW 21st Ave	NW 111th St - NW 101st St	<ul style="list-style-type: none"> • Lakeshore Elem 			
NW 68th St	NW 3 rd Ave - Hazel Dell Ave	<ul style="list-style-type: none"> • Hazel Dell Elem 			

* To be constructed after pending development.

It should be noted that, while young or inexperienced cyclists may ride on sidewalks, the use of sidewalks by bicyclists should be discouraged. Washington State Law does allow riding on sidewalks:

RCW 46.61.755: Traffic laws apply to persons riding bicycles.

- (1) *Every person riding a bicycle upon a roadway shall be granted all of the rights and shall be subject to all of the duties applicable to the driver of a vehicle by this chapter, except as to special regulations in RCW 46.61.750 through 46.61.780 and except as to those provisions of this chapter which by their nature can have no application.*
- (2) *Every person riding a bicycle upon a sidewalk or crosswalk must be granted all of the rights and is subject to all of the duties applicable to a pedestrian by this chapter.*

However, when cyclists travel on the sidewalks, parked cars impede visibility between the cyclist and motorists. In addition, drivers are less likely to expect bicyclists at intersections, and many crashes nationally are caused by sidewalk riding.²

Recommended On-Street Bikeways

The recommended bicycle network builds upon the system of previously proposed improvements and projects that connect to existing bikeways. The network has been developed to fill system gaps, continue expansion of the regional trail network, formalize existing routes used by bicyclists, and improve access between residential, employment, civic, and commercial destinations.

Depending on their location and context, Clark County's on-street bikeway network will include the following facilities:

- **Shoulder Bikeways** are paved roadways with striped shoulders wide enough for bicycle travel (four feet or wider). There should be little or no parking allowed on the pavement when the shoulder is intended to be used as a bikeway.
- **Bike Lanes** are separated from vehicle travel lanes with striping and include pavement stencils and signing. Bike lanes are appropriate on streets where higher traffic volumes and speeds indicate a need for greater separation. Bike lanes can be provided in

² *Pedestrian and Bicycle Crash Types of the Early 1990's*, Publication No. FHWA-RD-95-163, W.H. Hunter, J.C. Stutts, W.E. Pein, and C.L. Cox, Federal Highway Administration, Washington, DC, June, 1996.

the uphill direction on hilly streets where cyclists can match automobile speeds travelling downhill.

- **Shared Lane Markings** are high-visibility pavement markings that help position bicyclists within a shared travel lane. These markings are typically used on streets where dedicated bike lanes are desirable but are not possible due to physical or other constraints. Shared lane markings may be supplemented by signing.
- **Bicycle Boulevards** are developed through a combination of signing, striping, traffic calming measures and other streetscape treatments, and are intended to slow vehicle traffic while facilitating safe and convenient bicycle travel.

Table 8 lists the top-priority on-street bikeway projects, and Table 9 following provides an overview of the connections provided by the projects.

Table 8. Top Prioritized On-Street Bikeway Projects*

Street	From - To	Length (miles)	Closing Gaps	Land Uses	Safety and Comfort	Community Benefits	Implementation	Multi-Modal	Health Outcomes	Type	Planning-Level Cost Estimate [†]
NE 13th Ave	NE 88th St - NE 78th St	0.50	25	10	6	8	4	15	16	Shared Lane Markings	\$116,000
NE 179th St	NE 29th Ave - NE 102nd Ave	4.61	25	10	6	8	4	15	16	Bike Lane	\$1,071,000
NE 50th Ave	NE 119th St - NE Saint Johns Rd	1.23	25	10	6	10	4	15	16	Bike Lane	\$286,000
NE 94th St	NE 15th Ave - NE 25th Ave	0.50	25	10	8	10	4	15	19	Shared Lane Markings	\$116,000
NE 94th St	NW 21st Ave - NE 5th Ave	1.28	25	10	6	10	4	15	19	Shared Lane Markings	\$297,000
NE Delfel Rd	NE 199th St - NE 179th St	1.02	25	10	6	8	4	15	16	Bike Lane	\$237,000
NE/ NW 199th St	NW 11th Ave - NE 112th Ave	6.01	25	10	8	10	4	15	12	Bike Lane	\$1,396,000
NW 11th Ave [‡]	NW 199th St - Salmon Creek Greenway	3.56	25	10	6	10	4	15	16	Bike Lane	\$827,000
NW 21st Ave	NW 119th St - NW 78th St	2.01	25	10	6	10	4	15	14	Bike Lane	\$467,000
NW 2nd Ave/ NE 132nd St /	NW 139th St - NE 16th Ave	1.28	25	10	6	10	4	15	11	Shared Lane Markings	\$297,000

Street	From - To	Length (miles)	Closing Gaps	Land Uses	Safety and Comfort	Community Benefits	Implementation	Multi-Modal	Health Outcomes	Type	Planning-Level Cost Estimate [†]
NE 129th St											
NW 9th Ave	NW 99th St - NE 78th St	0.98	25	10	6	10	4	15	14	Bike Lane	\$228,000
NW Sluman Rd/ NW Overlook Dr/ NW Hazel Dell Way	NW 78th St/ NW Bacon Rd - NE Hazel Dell Ave	1.46	25	10	6	10	4	15	16	Bike Lane	\$339,000
NE 10 th Ave	NE Carty Rd – NE 179 th St	3.11	25	10	6	8	4	15	12	Bike Lane	\$723,000
Total On-Street Bikeways		27.55								\$6,400,000	

* Although WSDOT facilities are listed on this project list, WSDOT is not obligated to complete these projects.

† Costs for bikeway projects average the typical cost for roadway re-striping and shoulder construction, as the application is undetermined. Costs include striping removal or curb sawcut and aggregate base, striping, pavement markings, and signage, as well as engineering/construction, mobilization, A and E fees

‡ The on-street project would end at NW 131st Way and continue as a trail project, including a creek crossing, to connect with the Salmon Creek Greenway. The County should work with the Parks Department to plan and implement the trail portion of this corridor.

Table 9. Priority On-Street Bikeway Project Connections

Street	From - To	Bikeways	Schools	Parks	Transit	Other
NE 13th Ave	NE 88th St - NE 78th St	NE 78 th St NE 88 th St Hwy 99		Open space	NE 88 th St NW 78 th St	<ul style="list-style-type: none"> • Low-speed street • Alternative to Hwy 99
NE 179th St	NE 29th Ave - NE 102nd Ave	<ul style="list-style-type: none"> • NE 179th St • NE 15th Ave 	<ul style="list-style-type: none"> • Meadow Glade • Columbia Academy 	<ul style="list-style-type: none"> • Stanon Park • Fairgrounds 	<ul style="list-style-type: none"> • NE 10th Ave • NE 99th St 	<ul style="list-style-type: none"> • Access to Battle Ground
NE 50th Ave	NE 119th St - NE Saint Johns Rd	<ul style="list-style-type: none"> • St. Johns Rd • NE 99th St 	<ul style="list-style-type: none"> • Gaiser Middle School 	<ul style="list-style-type: none"> • Lalonde Park 	<ul style="list-style-type: none"> • St. Johns Rd 	<ul style="list-style-type: none"> • Connection across I-205
NE 94th St	NE 15th Ave - NE 25th Ave	<ul style="list-style-type: none"> • NE 15th Ave 		<ul style="list-style-type: none"> • Tenny Creek 		
NE 94th St	NW 21st Ave - NE 5th Ave	<ul style="list-style-type: none"> • NE Hazel Dell Ave 	<ul style="list-style-type: none"> • Eisenhower Elem • Lakeshore Elem 	<ul style="list-style-type: none"> • Lakeshore park • Eisenhower Park 	<ul style="list-style-type: none"> • NW 9th Ave 	
NE Delfel Rd	NE 199th St - NE 179th St	<ul style="list-style-type: none"> • NE 179th St 	<ul style="list-style-type: none"> • Southridge Elem 	<ul style="list-style-type: none"> • Fairgrounds 	<ul style="list-style-type: none"> • NE 10th Ave 	<ul style="list-style-type: none"> • Access along the I-5 corridor
NE/NW 199th St	NW 11th Ave - NE 112th Ave	<ul style="list-style-type: none"> • NE 72nd Ave 	<ul style="list-style-type: none"> • Southridge Elem 		<ul style="list-style-type: none"> • NE 10th Ave 	<ul style="list-style-type: none"> • Connection across I-5 and NE 10th Ave • Connection to Battle Ground
NW 11th Ave	NW 199th St - Salmon Creek Greenway	<ul style="list-style-type: none"> • Salmon Creek Greenway 	<ul style="list-style-type: none"> • Skyview High • Southridge Elem • Alki Jr. High • Chinook Elem 	<ul style="list-style-type: none"> • Salmon Creek Greenway 	<ul style="list-style-type: none"> • NW 139th St 	<ul style="list-style-type: none"> • Crossing over Whipple Creek
NW 21st Ave	NW 119th St - NW 78th St	<ul style="list-style-type: none"> • NW 119th St • NW 99th St • NW 78th St 	<ul style="list-style-type: none"> • Lakeshore Elem 	<ul style="list-style-type: none"> • Lakeshore Park 	<ul style="list-style-type: none"> • NW 21st Ave • NW 78th St 	
NW 2nd Ave/NE 132nd St/NE 129th St	NW 139th St - NE 16th Ave		<ul style="list-style-type: none"> • Skyview High • Salmon Creek Elem • Columbia River High 	<ul style="list-style-type: none"> • H.B. Fuller Sports Complex 	<ul style="list-style-type: none"> • NW 139th St • I-5 	<ul style="list-style-type: none"> • Potential future connection to Salmon Creek Greenway
NW 9th Ave	NW 99th St - NE 78th St	<ul style="list-style-type: none"> • NW 99th St • NW 78th St 	<ul style="list-style-type: none"> • Eisenhower Elem • Jason Lee Jr. High 	<ul style="list-style-type: none"> • Eisenhower Park 		
NW Sluman Rd/ NW Overlook Dr/ NW Hazel Dell Way	NW 78th St/NW Bacon Rd - NE Hazel Dell Ave	<ul style="list-style-type: none"> • NW 78th St • NE Hazel Dell Ave • NE 63rd St 				<ul style="list-style-type: none"> • Alternative to Hwy 99/NW 78th St
NE 10 th Ave	NE Carty Rd – NE 179 th St	<ul style="list-style-type: none"> • NE 179th St • NE 259th St 		<ul style="list-style-type: none"> • Fairgrounds 	<ul style="list-style-type: none"> • I-5 • NE 219th St 	

This page intentionally left blank

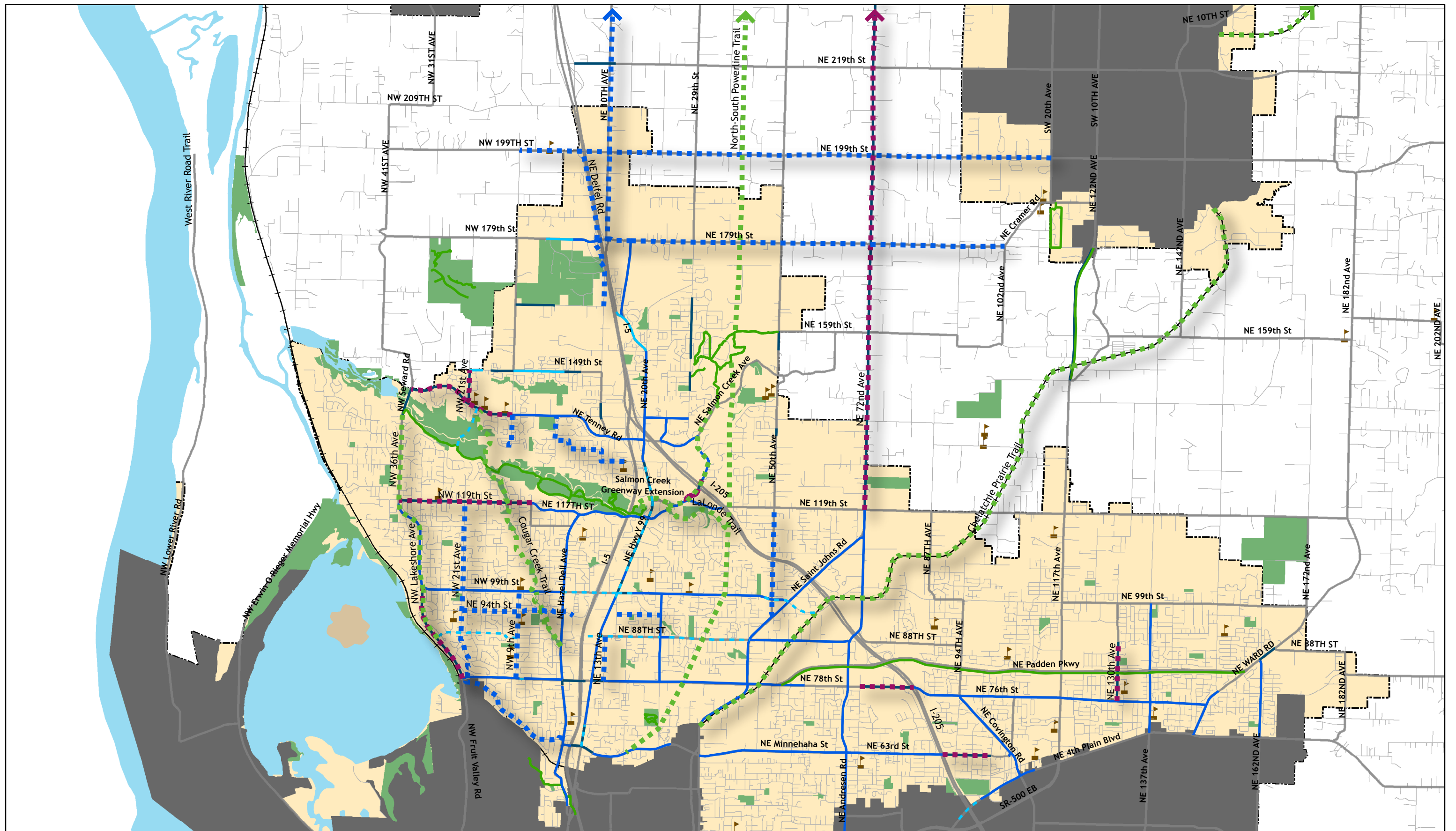

Map 5. Top Tier Bikeway and Trail Projects

Clark County
Bicycle and Pedestrian Master Plan

Source: Data obtained from Clark County
Author: HWK
Date: September 2010

- | | | |
|-------------------------------|--------------------------------|-----------------------|
| Planned projects | Off-Street trails and pathways | Railroad |
| Bikeway projects | Bike lane | School |
| Restriping bike lane projects | Bike lane one-side | Parks |
| Trail and pathway projects | Shoulder bikeway | Urban growth boundary |



0 0.5 1 Miles

This page intentionally left blank.

Determination of appropriate treatments on each street depends on traffic volumes, vehicle and bicycle circulation patterns, street connectivity, street width, physical constraints, and other parameters. In addition to specific locations provided in Table 8, Clark County should seek to improve intersections for bicyclists by calibrating signal loop detectors for actuation by bicycles. Other intersection improvements could include bike boxes and other turn lane treatments.

In addition to bikeway projects that require roadway reconstruction, shoulder widening, travel, parking, or turn lane reduction, some bike lanes can be provided through simple roadway re-striping. The projects in Table 10 were identified in the bike lane inventory as having shoulders with sufficient width to accommodate bicyclists (four feet or wider) on both sides of the road.

Table 10. Top Prioritized Roadway Restriping Projects

Street	From - To	Length (miles)	Closing Gaps	Land Uses	Safety and Comfort	Community Benefits	Implementation	Multi-Modal	Health Outcomes	Planning-Level Cost Estimate*
NE 10 th Ave	NE 259 th St – NE Carty Rd	0.89	25	10	8	1	5	1	10	\$282,000
NE 130 th Ave	NE 89 th St - NE 78 th St	0.67	25	10	8	10	5	15	13	\$212,000
NE 63 rd St	I-205 - NE 102 nd Ave	0.55	25	10	6	4	5	15	16	\$174,000
NE 78 th St	NE 72 nd Ave - I-205	0.61	25	10	6	15	5	4	16	\$2,211,000
NE 72 nd Ave	NE 259 th St - NE 119 th St	6.98	25	10	6	10	5	15	10	\$193,000
NE Edmunds Rd	NE 174 th Ct - NE 29 th St	0.57	25	10	12	10	5	15	10	\$181,000
NE Salmon Creek Ave	NE 125 th St - NE 117 th St	0.45	25	10	6	10	5	15	19	\$143,000
NW 119 th St	NW 36 th Ave - NW 21 st Ave	1.50	25	10	6	10	5	15	12	\$475,000
NW 21 st Ave	NE 149 th St - NW Bliss Rd	0.37	25	10	6	10	5	15	14	\$117,000
NW Bliss Rd/ NW Hathaway Rd/ NW 139 th St	NW Seward Rd - NW 11 th Ave	1.26	25	10	6	10	5	15	14	\$399,000
NW Lakeshore Ave	NW 99 th St - NW 78 th St	1.17	25	7	6	10	5	15	14	\$371,000
Total Roadway Restriping Projects:		13.31								\$4,476,000

* Costs for roadway re-striping projects include striping removal, re-striping, pavement markings, and signage, as well as engineering/construction, mobilization, A and E fees, and contingency.

Table 11. Priority Roadway Restriping Project Connections

Street	From - To	Bikeways	Schools	Parks	Transit	Other
NE 130th Ave	NE 89th St - NE 78th St	<ul style="list-style-type: none"> ● Padden Parkway Trail ● NE 76th St 	<ul style="list-style-type: none"> ● Heritage High 	<ul style="list-style-type: none"> ● Mackie Park 	<ul style="list-style-type: none"> ● NE 99th St 	<ul style="list-style-type: none"> ● Connection over Padden Parkway
NE 72nd Ave	NE 259th St - NE 119th St		<ul style="list-style-type: none"> ● Pacific Jr. High ● Harmony Elem 	<ul style="list-style-type: none"> ● Lower Daybreak Park ● Maple Crest Park 	<ul style="list-style-type: none"> ● SR 502 	<ul style="list-style-type: none"> ● Connection to Vancouver
NE Edmunds Rd	NE 174th Ct - NE 29th St					
NE Salmon Creek Ave	NE 125th St - NE 117th St	<ul style="list-style-type: none"> ● NE 117th St 				<ul style="list-style-type: none"> ● Connection over I-205
NW 119th St	NW 36th Ave - NW 21st Ave	<ul style="list-style-type: none"> ● Salmon Creek Greenway ● NE 117th St 	<ul style="list-style-type: none"> ● Felida Elementary 	<ul style="list-style-type: none"> ● Salmon Creek Greenway 	<ul style="list-style-type: none"> ● NW 36th Ave ● NW 21st Ave 	
NW 21st Ave	NE 149th St - NW Bliss Rd	<ul style="list-style-type: none"> ● NW 149th St ● NW Bliss Rd/ NW Hathaway Rd 	<ul style="list-style-type: none"> ● Skyview High ● Southridge Elem ● Alki Jr. High ● Chinook Elem 		<ul style="list-style-type: none"> ● NW Bliss Rd/ NW Hathaway Rd 	
NW Bliss Rd/NW Hathaway Rd/NW 139th St	NW Seward Rd - NW 11th Ave	<ul style="list-style-type: none"> ● Salmon Creek Greenway 	<ul style="list-style-type: none"> ● Skyview High ● Alki Jr. High ● Chinook Elem 	<ul style="list-style-type: none"> ● Salmon Creek Greenway 		
NE 63 rd St	I-205 - NE 102 nd Ave	<ul style="list-style-type: none"> ● NE 63rd St ● NE Covington Rd 		<ul style="list-style-type: none"> ● Walnut Grove Park ● Orchards Park 	<ul style="list-style-type: none"> ● NE 63rd St ● NE Covington Rd 	
NE 78 th St	NE 72 nd Ave - I-205	<ul style="list-style-type: none"> ● NE 76th St ● NE 72nd Ave 				<ul style="list-style-type: none"> ● Alternative (more direct) to Padden Parkway
NW Lakeshore Ave	NW 99th St - NW 78th St	<ul style="list-style-type: none"> ● NW 78th St ● NW 99th St 	<ul style="list-style-type: none"> ● Lakeshore Elem 		<ul style="list-style-type: none"> ● NW 78th St 	
NE 10 th Ave	NE 259 th St – NE Carty Rd	<ul style="list-style-type: none"> ● NE 259th St 		<ul style="list-style-type: none"> ● Lewis River Greenway 	<ul style="list-style-type: none"> ● NE 219th St 	<ul style="list-style-type: none"> ● Connection to Ridgefield



Figure 20. Path users combining recreation and working.

Clark County’s entire street network is effectively the community’s bicycle network, regardless of whether or not a bikeway stripe, stencil, or sign is present. The designation of certain roads as bike routes is not intended to imply that these are the only roadways intended for bicycle use, or that bicyclists should not be riding on other streets. Rather, the designation of a network of on-street bikeways recognizes that certain roadways are preferred bicycle routes for most users, for reasons such as directness or access to significant destinations, allowing the county to focus on building the primary network.

Recommended Regional Pathway Improvements

This Plan incorporates the sixteen regional land trails identified in the adopted 2006 *Clark County Trails and Bikeway System Plan* and the six Greater Clark Parks District trails. These identified trails inform where on-street bicycle and pedestrian improvements can seamlessly connect the proposed on-street system to existing and planned trails throughout unincorporated Clark County. The trails identified in these plans are regional in nature, meaning they extend across and through communities to link local and regional destinations such as schools, commercial areas and parks. As identified by Clark County they can be organized into three categories: shared-use pathways, primitive trails, and side-pathways and are described below to better understand how they function.

This plan evaluated the planned trails identified in the *Clark County Trails and Bikeway System Plan* and the six Greater Clark Parks District trails and prioritized ten that have sections that meet this plan’s identified criteria for recommended improvements.

Side Path Parkways

Side paths parkways are directly adjacent to roadways and within the street right-of-way. Examples in Clark County include the Padden Parkway and the SR 503 Pathway. They serve both bicyclists and pedestrians and are wider than a standard sidewalk. Side paths provide commuter routes between residential areas and employment centers, as well as to retail areas.

Recommended side path pathways include:

- Salmon Creek Greenway Trail- the portion between HWY 99 and WSU including improvements to 119th St. and Salmon Creek Ave.
- NW 36th Ave- the portion between 78th St. and Bliss Rd.

Shared-Use Paths

Shared-use paths (also referred to as “trails” and “multi-use paths”) are dedicated off-street paved facilities that accommodate walkers, bicyclists



Figure 21. The SR 503 Pathway is a side path that provides a continuous nonmotorized route.

and sometimes equestrians. In Clark County they are primarily located along and within parks, greenways and utility corridors and span three to eight miles.

Recommended shared-use paths include:

- Chelatchie Prairie Rail Trail
 - Vancouver City Line to Battle Ground City Line
 - Battle Ground City Line to Yacolt City Line
 - Yacolt City line to County line
- Salmon Creek Greenway Trail – section between the eastern Klineline pond and Klineline Bridge and 119th St.
- North South Power-line Trail

Primitive Trails

Primitive trails identified in this Plan are dedicated off-street non-paved facilities that largely accommodate walkers. Because they are located within close proximity to stream courses, wetlands and other sensitive lands, development is anticipated to be limited to soft surfaces. However they still provide valuable connections within and across neighborhoods.

Recommendations for primitive trails were identified in the Greater Clark Parks District and include the following:

- Cougar Creek Trail
- LaLonde Trail



Figure 22. Paved regional trails accommodate all types of cyclists and pedestrians.



Figure 23. Cougar Creek Trail at Eisenhower Elementary School.



Figure 24. The LaLonde Creek Trail would be a rustic footpath providing pedestrian access.

Table 12. Priority Trail Projects*

Trail	From - To	Type	Length (miles)	Closing Gaps	Land Uses	Safety and Comfort	Community Benefits	Implementation	Multi-Modal	Health Outcomes	Planning-Level Cost Estimate [†] (millions)
NE 119 th St/ NE Salmon Creek Ave	Highway 99 - WSU	Side Path	1.7	25	10	10	10	3	15	19	\$2.0
NW 36th Ave	Salmon Creek Greenway Trail - NW 88th St	Side Path	2.7	25	10	15	10	1	15	17	\$3.3
Chelatchie Prairie Trail	Vancouver City Line - Battle Ground City Line	Shared -use	9.3	25	10	15	8	3	15	20	\$11.2
Chelatchie Prairie Trail	Yacolt City Line - Battle Ground City Line	Shared -use	11.5	25	10	15	10	3	1	13	\$13.8
Chelatchie Prairie Trail	Yacolt City line - county line	Shared -use	19.5	8	10	15	10	3	1	13	\$23.2
Salmon Creek Greenway	Eastern Klineline pond - 119 th St	Shared -use	0.3	25	10	15	10	1	15	20	\$0.4
North South Powerline Trail	NE Cedar Creek Rd - NE 63 rd St	SUP	17.9	25	10	15	10	1	15	16	\$8.4
Cougar Creek Trail	NW 139th St - NE Hazel Dell Ave	Trail	3.2	25	10	15	10	1	15	20	\$3.8
LaLonde Trail	NE Hwy 99 - North-South Powerline Trail	Trail	1.6	25	10	15	10	1	15	20	\$0.7
Total Trail Projects			66.7								\$80.1

* Development of off-street trail projects will be funded primarily by the Vancouver-Clark Parks Department, with the aid of federal grant monies.

† Costs for off-street trails depend on critical areas, topography, wetland, right-of-way acquisition, and other factors. This analysis uses a common cost of \$1.2 million per mile of off-street trail, as provided by VCPRD for planning purposes. As development is initiated for each project, the trail will undergo more thorough review and estimates are expected to be refined to reflect the unique environmental conditions and resulting compatible trail profile.

Table 13. Priority Trail Project Connections

Trail	From - To	Bikeways	Schools	Parks	Transit	Other
NE 119 th St/ NE Salmon Creek Ave	Highway 99 - WSU	<ul style="list-style-type: none"> NE 29th Ave WSU Trail Salmon Creek Greenway 	<ul style="list-style-type: none"> WSU Pleasant Valley Elem & Jr. High 	<ul style="list-style-type: none"> Pleasant Valley Park Salmon Creek Park 	<ul style="list-style-type: none"> Hwy 99 	<ul style="list-style-type: none"> Provides on-street connection from regional trail to WSU
NW 36 th Ave	Salmon Creek Greenway Trail - NW 88 th St	<ul style="list-style-type: none"> NW Lakeshore Ave NW 119th St NW 99th St 	<ul style="list-style-type: none"> Felida Elem Lakeshore Elem 		<ul style="list-style-type: none"> NW 199th St 	
Chelatchie Prairie Trail	Vancouver City Line -Battle Ground City Line	<ul style="list-style-type: none"> NE St. Johns Rd NE 72nd Ave SR 509 Trail 	<ul style="list-style-type: none"> Laurin Elem 	<ul style="list-style-type: none"> Brush Prairie 	<ul style="list-style-type: none"> NE St. James Rd NE 78th St NE 117th Ave/NE Caples 	<ul style="list-style-type: none"> Connection to Vancouver, Battle Ground,
Chelatchie Prairie Trail	Yacolt City Line - Battle Ground City Line	<ul style="list-style-type: none"> Battle Ground Lake trails 	<ul style="list-style-type: none"> Yacolt Elem 	<ul style="list-style-type: none"> Battle Ground Lake Lucia Falls Park Moulton Falls Park 		<ul style="list-style-type: none"> Connection to Battle Ground, Yacolt
Chelatchie Prairie Trail	Yacolt City line - county line		<ul style="list-style-type: none"> Yacolt Elem 	<ul style="list-style-type: none"> Siouxon Regional Park 		<ul style="list-style-type: none"> Connection to Yacolt
Salmon Creek Greenway	Eastern Klineline pond - 119 th St	<ul style="list-style-type: none"> Salmon Creek Greenway 			<ul style="list-style-type: none"> Salmon Creek Greenway 	<ul style="list-style-type: none"> Across Hwy 99
North South Powerline Trail	NE Cedar Creek Rd - NE 63 rd St	<ul style="list-style-type: none"> NE Minnehaha St NE 88th St, NE 99th St, NE 119th St 	<ul style="list-style-type: none"> Gaiser Jr. High Pleasant Valley Jr. High 	<ul style="list-style-type: none"> East Fork Lewis River Greenway 	<ul style="list-style-type: none"> NE 99th St 	<ul style="list-style-type: none"> Provides north-south connectivity across the county
Cougar Creek Trail	NW 139 th St - NE Hazel Dell Ave	<ul style="list-style-type: none"> Salmon Creek Greenway 	<ul style="list-style-type: none"> Columbia River High Eisenhower Elem 	<ul style="list-style-type: none"> Salmon Creek Greenway 	<ul style="list-style-type: none"> Transit station on Hazel Dell Ave 	<ul style="list-style-type: none"> crossing over Salmon Creek
LaLonde Trail	NE Hwy 99 - North-South Powerline Trail	<ul style="list-style-type: none"> NE 117th St Salmon River Greenway 		<ul style="list-style-type: none"> Sherwood North Park Salmon Creek 	<ul style="list-style-type: none"> NE Hwy 99 	<ul style="list-style-type: none"> Will connect to proposed North-South Powerline Trail

Active Transportation and Regional Trails Network: The Intertwine

In addition to improving bicycle and pedestrian mobility throughout Clark County, the plan also contributes to the ever-growing regional parks, active transportation, natural areas, and conservation coalition, coined The Intertwine in 2009. The *Clark County Bicycle and Pedestrian Plan* provides a vested regional planning document that can be leveraged as part of the Intertwine to develop partnerships, seek funding and provide weight to advocate for realizing the walking and bicycling facilities and programs recommended in this plan.³

Consideration for Trails and Railroads

Clark County purchased the Chelatchie Prairie railroad right-of-way in 1985. Also known as the Lewis and Clark Railroad, the existing rail line extends thirty-three miles diagonally through the county from Burnt Bridge Creek at Interstate 5, to the site of an old paper mill a few miles from Yale Reservoir. Clark County acquired the right-of-way both for commercial transportation use and as a trail corridor. The county is currently leasing the rail corridor to several rail operators who are using the corridor for light-industrial rail commerce and passenger excursion trips. Clark County acquired the corridor to maintain commercial freight and passenger rail service and to establish a non-motorized trail across the county. The Chelatchie Prairie Rail-with-Trail (RWT) is envisioned as a 33-mile multi-use trail within the railroad right-of-way where possible. In some areas the trail alignment will use existing trails

In 2008 the Clark County Board of Commissioners adopted the Chelatchie Rail with Trail Feasibility Study to guide future development of the rail with trail. The following highlights identified in the feasibility study specifically address railroad and trail compatibility considerations for the future trail.

- New at-grade crossing are prohibited and new trails that may cross the railroad will need to be designed to utilize existing crossings.
- Planning and engineering of the trail should involve close collaboration with railroad operations and maintenance staff and the Washington Utilities and Transportation Commission (WUTC) to achieve a suitable rail with trail design.

³ Additional information about the Intertwine project available at: www.theintertwine.org/

- The trail development should reflect standards set by adjacent railroads for crossings and other design elements with emphasis on signage to reflect behavior around the tracks.
- The trail must be designed to meet both the operational needs of the railroad and the safety of the trail users.

Chapter 5. Bicycle Parking Standards and Guidelines

Bicycle parking is an important component in planning bicycle facilities and encouraging people to use their bicycles for everyday transportation. Bicycles are one of the top stolen items in most communities, with components often being stolen even when the bicycle frame is securely locked to a rack. Because many of today's bicycles are often high-cost and valuable items, many people will not use a bicycle unless they are sure that there is secure parking available at their destinations.

This chapter outlines bicycle parking facility types and the requirements of short- and long-term parking, as well as other types of end-of-trip facility options. It outlines the existing policies addressing the development of bicycle parking within Clark County and the six cities. Best practices of supportive policies, both locally and internationally, are then discussed, and changes are recommended to ensure that Clark County policy is supportive of developing the most appropriate bicycle parking facilities possible.

Bicycle parking facilities that are conveniently located and adequate in both quantity and quality can help to reduce bicycle theft and to eliminate inappropriate parking, benefiting everyone. Bicycle parking is highly cost-effective compared to automobile parking. One way to incentivize the development of bicycle parking is to offer reduced automobile parking minimums for developments that include bicycle parking.

Bicycle Parking Facility Types

Bicyclists need parking options that can provide security against theft, vandalism, and weather. Like automobile parking, bicycle parking is most effective when it is located close to trip destinations, is easy to access, and is easy to find. Where quality bicycle parking facilities are not provided, determined bicyclists lock their bicycles to street signs, parking meters, lampposts, benches, or trees. These alternatives are undesirable as they are usually not secure, may interfere with pedestrian movement, and can create liability or damage street furniture or trees.

In a nationwide Harris Poll conducted in 1991, almost half the respondents stated that they would sometimes commute to work by bicycle, or commute more often, if there were showers, lockers, and secure bicycle storage at work. Cyclists' needs for bicycle parking range from simply a convenient piece of street furniture, to storage in a bicycle locker that affords weather, theft and vandalism protection, gear storage space, and 24-hour personal access. Most bicycles today cost 350 dollars to over 2,000 dollars and are

one of the top stolen items in all communities, with components being stolen even when a bicycle is securely locked. Theft can be a serious deterrent to riding, especially for low-income riders or those with particularly expensive or rare bicycles. Where a cyclist's needs falls on this spectrum is determined by several factors:

Bicycle parking can be broadly defined as either short-term or long-term parking:

- Short-term parking: Bicycle parking meant to accommodate visitors, customers, messengers and others expected to depart within two hours; requires approved standard rack, appropriate location and placement, and weather protection.
- Long-term parking: Bicycle parking meant to accommodate employees, students, residents, commuters, and others expected to park more than two hours. This parking is to be provided in a secure, weather-protected manner and location.

Short-Term Bicycle Parking

Short-term bicycle parking facilities are intended to provide short-term (under 2 hours) bicycle parking, and include racks which permit the locking of the bicycle frame and one wheel to the rack and support the bicycle in a stable position without damage to wheels, frame or components (Figure 25). Wherever possible, bicycle parking should be covered to protect the bike from rain, snow and other elements. Covered parking areas should have at least six or seven feet of clearance, but not so high as to allow rain and snow to easily blow under the roof. Short-term bicycle parking is currently provided at no charge at most locations. Such facilities should continue to be free, as they provide minimal security, but encourage cycling and promote proper bicycle parking.

Recommendations for short-term bicycle parking include the following:

- Bicycle parking spaces should be at least six feet long and two-and-a-half feet wide, and overhead clearance for covered spaces should be at least seven feet.
- A five-foot aisle for bicycle maneuvering should be provided and maintained beside or between each row of bicycle parking.
- Bicycle racks or lockers should be securely anchored to the surface or structure.



Figure 25. On-street bicycle parking 'corrals' have been used in downtown Vancouver to increase parking capacity.

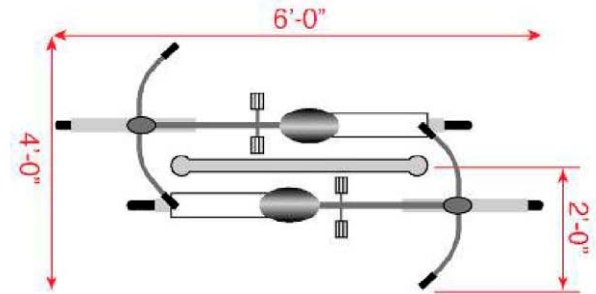

Figure 26. Inverted 'U' rack.

Where sidewalks are too narrow or obstructed, bicycle parking can be placed in the street in lieu of on-street vehicle parking. Clustered racks can be installed in a car parking space protected by bollards or curbs (Figure 25). Alternatively, racks can be installed on sidewalk curb extensions where adequate sight distance can be provided. Installing bicycle parking directly in a car parking space incurs only the cost of the racks and bollards or other protective devices.

A curb extension is more expensive to install, and can be prohibitively expensive if substantial drainage and/or utility work is necessary. Costs may be less if the curb extension is installed as part of a larger street or pedestrian improvement project.

While on-street bicycle parking may reduce automobile parking, auto parking loss can be mitigated by: adding auto parking spaces by consolidating driveways, moving fire hydrants, or otherwise finding places where auto parking can be allowed where it is currently prohibited. Bicycle and motorcycle parking can also be combined.

On-street bicycle parking may be installed at intersection corners or at mid-block locations. Mid-block on-street parking may be closer to cyclists' destinations, although it could force cyclists to dismount and walk to the parking site if access from the street is difficult or dangerous. Combining a mid-block pedestrian crossing with mid-block on-street parking facilities could mitigate this situation.



Figure 27. A local bicycle advocacy group, Bike Me!, provides bicycle parking at public events in Vancouver.

Table 14. Short-Term Bicycle Rack Placement Guidelines

Design Issue	Recommended Guidance
Minimum Rack Height	To increase visibility to pedestrians, racks should have a minimum height of 33 inches or be indicated or cordoned off by visible markers.
Signing	Where bicycle parking areas are not clearly visible to approaching cyclists, signs at least 12 inches square should direct them to the facility. The sign should give the name, phone number, and location of the person in charge of the facility, where applicable.
Lighting	Lighting of not less than one foot-candle illumination at ground level should be provided in all bicycle parking areas.
Frequency of Racks on Streets	In popular retail areas, two or more racks should be installed on each side of each block. This does not eliminate the inclusion of requests from the public which do not fall in these areas. Areas officially designated or used as bicycle routes may warrant the consideration of more racks.
Location and Access	Access to facilities should be convenient; where access is by sidewalk or walkway, curb ramps should be provided where appropriate and ADA compliant. Parking facilities intended for employees should be located near the employee entrance, and those for customers or visitors near the main public entrances. (Convenience should be balanced against the need for security if the employee entrance is not in a well traveled area). Bicycle parking should be clustered in lots not to exceed 16 spaces each. Large expanses of bicycle parking make it easier for thieves to operate undetected.
Locations within Buildings	Provide bike racks within 50 feet of the entrance. Where a security guard is present, provide racks behind or within view of a security guard. The location should be outside the normal flow of pedestrian traffic.
Locations near Transit Stops	To prevent bicyclists from locking bikes to bus stop poles - which can create access problems for transit users, particularly those who are disabled - racks should be placed in close proximity to transit stops where there is a demand for short-term bike parking.
Locations within a Campus-Type Setting	Racks are useful in a campus-type setting at locations where the user is likely to spend less than two hours, such as classroom buildings. Racks should be located near the entrance to each building. Where racks are clustered in a single location, they should be surrounded by a fence and watched by an attendant. The attendant can often share this duty with other duties to reduce or eliminate the cost of labor being applied to the bike parking duties; a cheaper alternative to an attendant may be to site the fenced bicycle compound in a highly visible location on the campus. For the long-term parking needs of employees and students, attendant parking and/or bike lockers are recommended.
Retrofit Program	In established locations, such as schools, employment centers, and shopping centers, the City should conduct bicycle parking audits to assess the bicycle parking availability and access, and add in additional bicycle racks where necessary.

Long-Term Bicycle Parking

Long-term bicycle parking facilities are intended to provide secure long-term bicycle storage. Long-term facilities protect the entire bicycle, its components and accessories against theft and against inclement weather, including snow and wind-driven rain (Figure 28). Wherever possible, bicycle parking should be covered to protect the bike from rain, snow and other elements. Examples include lockers, check-in facilities, monitored parking, restricted access parking, and personal storage.



Figure 28. Bike lockers, such as this one in downtown Vancouver, are a standard form of long term bicycle parking.

Long-term parking facilities are more expensive to provide than short-term facilities, but are also significantly more secure. Although many bicycle commuters would be willing to pay a nominal fee to guarantee the improved safety of their bicycle, long-term bicycle parking should be free wherever automobile parking is free. Potential locations for long-term bicycle parking include large employers and institutions where people use their bikes for commuting, and not consistently throughout the day. An advantage of lockers is that they can be configured to more easily accommodate different styles of bicycles, such as recumbent bicycles.

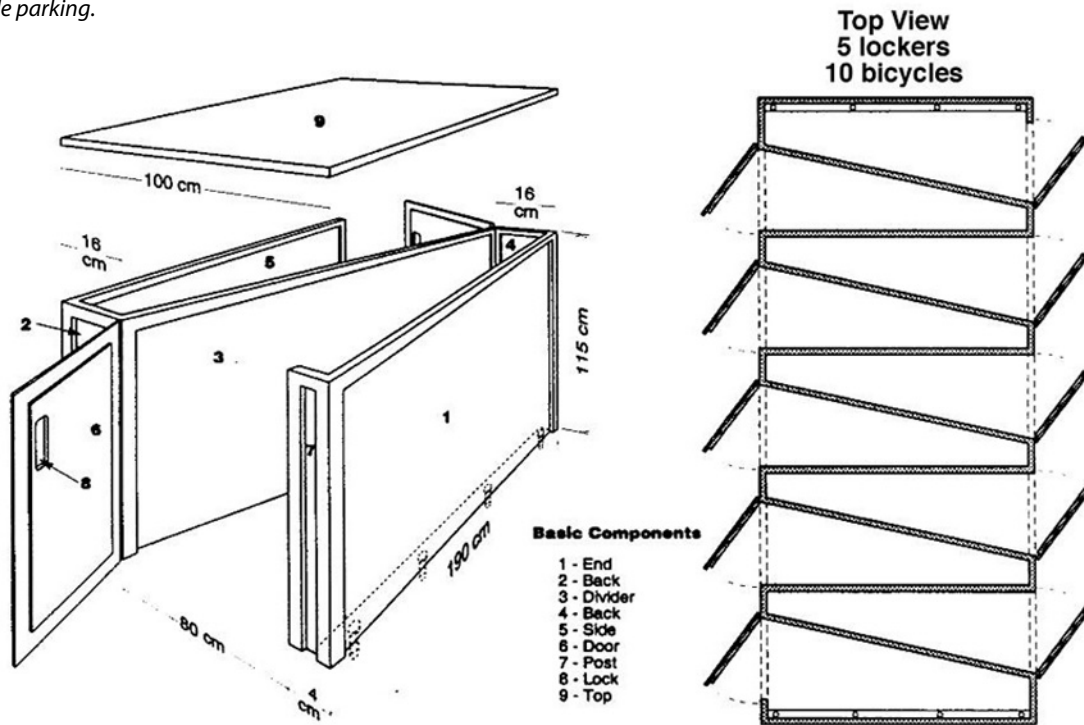

Figure 29. Cycle Safe Lockers

Attendant Bicycle Parking

Attendant parking is practical where there is a heavy demand for secure bicycle parking. College campuses and high schools are obvious locations, as are employment locations with a large commuter bicycling population. Bicycle attendant duties become more cost-effective when shared with other duties, such as garage attendant, security guard, or private bicycle maintenance and repair operator (Figure 30). Attendant parking should be particularly considered for locations with heavy demand for bike parking but no existing bike parking facilities.

Bikestations

A Bikestation offers secure, attended bicycle parking in a centrally-located hub of transit-oriented activity. Bikestations allow cyclists to park their bicycle while they shop or commute nearby. The look, location, and design details differ from city to city and station to station; some Bike stations are located in their own buildings, offering a café atmosphere to cyclists, while others are located within a transit station, offering free overnight bike storage (Figure 31).

Bikestation operating costs include staffing, data processing (such as a computer system to track bikes), security, marketing, materials, utilities, business fees, and other overhead. Funding sources can include the usual local, state and federal non-motorized transportation funds, as well as user fees, local development fees, and income from associated retail establishments.

Changing Facilities

Aside from bicycle parking, other end-of-trip facilities for bicyclist include changing areas, clothes lockers and showers, which allow bicyclists to clean up after riding. For encouraging cycle commuting by more middle- and upper-income residents, who are likely to have professional office jobs, there will need to be a place for them to quickly change into work clothes. In order to best encourage bicycle commuting, these facilities need to be located at places of employment, so that an employee could bicycle in, then shower and change before starting work. Shower and locker facilities may exist in some office buildings and other employment centers in Clark County, but they do not appear to be very common. Health and fitness clubs can offer an alternative place to shower/change for commuter cyclists, but only function for commuter cyclists if the facilities are located conveniently close to the place of employment. In encouraging the new demographic of riders to try cycle commuting, facilities such as showers, lockers, and bike parking becomes nearly as important as providing the bicycle facilities themselves. Clark County can support local efforts to



Figure 30. Racks in Bikestation, Freiburg (Germany)



Figure 31. Bikestation in Long Beach (CA)

strengthen development ordinances that require shower and locker facilities based on employment densities.

Bicycle Parking Supportive Policies

This section outlines existing policies that guide the development of bicycle parking. It considers best practices of short-term and long-term parking, both locally and internationally. Finally, specific recommendations are provided for Clark County to support the development of bicycle parking.

Bicycle Parking Standards in Clark County

The 2008 Washington State Bicycle Facilities and Pedestrian Walkways Plan states that approximately \$80,000 of unfunded bicycle parking needs have been identified in local transportation improvement plans. With the exception of Vancouver, none of the Comprehensive Plans for the local jurisdictions mention bicycle parking as a consideration for encouraging bicycling in the communities.

The City of Vancouver published Bicycle Parking Standards and Guidelines, which provides information about desired quantity and requirements for bicycle parking facilities. It outlines what are unacceptable styles of racks, and provides diagrams and examples. The City of Vancouver maintains all bicycle parking facilities within the public right-of-way.

Table 15 shows the parking standards recommended by the City of Vancouver for minimum recommended number of bicycle parking spaces on differing land uses. The term “Class I” is for short-term and “Class II” for long-term parking facilities. It is recommended to provide sheltered parking if more than ten Class II spaces are available. These standards are based on Vancouver’s Parking Standards.

Table 15. Vancouver Bicycle Parking Recommended Standards

Use	Recommended Bicycle Parking	Class and Percent of Bicycle Parking
Multi-Dwelling Units	1 space per 2 units except elderly, which is 1 space per 20 units	100% Class II
Emergency Services	1 space per 3,000 sq. ft. of floor area	20% Class I; 80% Class II
Human Services Facilities	1 space per 3,000 sq. ft. of floor area	20% Class I; 80% Class II
Neighborhood Parks	4 spaces per acre	100% Class II
Community Parks	5% of auto spaces	20% Class I; 80% Class II
Elementary Schools	1 space per 25 students	20% Class I; 80% Class II
Middle Schools	1 space per 40 students	20% Class I; 80% Class II
High Schools	1 space per 60 students	20% Class I; 80% Class II
Commercial Lodging	1 space per 20 rooms	100% Class I
Restaurants with drive-thru	1 space per 1,000 sq. ft. of floor area	20% Class I; 80% Class II
Restaurants without drive thru	1 space per 1,000 sq. ft. of floor area	20% Class I; 80% Class II
General Retail Sales	1 space per 4,000 sq. ft. of floor area	20% Class I; 80% Class II
Office Campus	1 space per 3,000 sq. ft. of floor area	20% Class I; 80% Class II
Light Industrial	1 space per 10,000 sq. ft. of floor area	20% Class I; 80% Class II
Heavy Industrial	1 space per 10,000 sq. ft. of floor area	20% Class I; 80% Class II

City of Vancouver Municipal Code 20.945.050 states that bicycle parking must meet the following standards:

- Bicycle parking must be provided at the ground level, and may be provided in floor, or wall racks that must hold bicycles securely by the means of the frame. Bicycles may be tipped vertically for storage, but not hung above the ground. If the bicycle parking is placed in the public right-of-way, it shall not obstruct pedestrian walkways and shall meet all of the requirements outlined in obtainment of the street use permit.
- Where required bicycle parking is provided with racks, the racks must meet the following standards:
 - The parking spaces shall be at least 2' wide and 6' long with an overhead clearance of at least 7', and with a 5' access aisle
 - The rack must hold the bicycle securely by means of the frame. The frame must be able to be supported so that the bicycle cannot be pushed or fall to one side in a manner that will damage the wheels

- The bicycle frame and one wheel can be locked to the rack with a high-security, U-shaped shackle lock if both wheels are left on the bicycle; and
- The rack must be securely anchored with theft resistant hardware
- Where bicycle parking is provided with lockers, such lockers must meet the following standards:
 - An area of at least 6' of horizontal distance shall be provided around the entrance of each locker that is free from obstructions, an overhead clearance of at least 7', and with a 5' access aisle; and
 - The lockers must be securely anchored

The City of Vancouver Comprehensive Plan also outlines bicycle parking guidelines under the Community Design heading. Policy 12.2.4 reads, “Establish development standards for higher densities and intensities of development along priority and high capacity transit corridors that encourage pedestrian, bicycle, and public transit usage.”

Bicycle Parking Standards Best Practices

Best practices in bicycle parking standards outline specific guidelines for minimum quantities of parking spaces at different land uses. An example is from the Oregon Department of Land Conservation and Development (DLCD) guidelines, shown in Table 16.

Table 16. Minimum Required Bicycle Parking Spaces, DLCD

Use Categories	Specific Uses	Long-Term Spaces	Short-Term Spaces
Residential Categories			
Household Living	Multifamily	1 per 4 units	2, or 1 per 20 units
Group Living		2, or 1 per 20 bedrooms	None
	Dormitory	1 per 8 bedrooms	None
Commercial Categories			
Retail Sales and Service		2, or 1 per 12,000 sq. ft. of floor area	2, or 1 per 5,000 sq. ft. of floor area
	Lodging	2, or 1 per 20 rentable rooms	2, or 1 per 20 rentable rooms
Office		2, or 1 per 10,000 sq. ft. of floor area	2, or 1 per 40,000 sq. ft. of floor area
Commercial Outdoor Recreation		8, or 1 per 20 auto spaces	None
Major Event Entertainment		8, or 1 per 40 seats or per CU review	None
Industrial Categories			
Manufacturing and Production		2, or 1 per 15,00 sq. ft. of floor area	None
Warehouse and Freight Movement		2, or 1 per 40,000 sq. ft. of floor area	None
Institutional Categories			
Basic Utilities	Bus transit center	8	None
Community Service		2, or 1 per 10,000 sq. ft. of floor area	or 1 per 10,000 sq. ft. of floor area
	Park and ride	8, or 5 per acre	None
Parks (active recreation areas only)		None	8, or per CU review
Schools	Grades 2-5	1 per classroom, or per CU review	1 per classroom, or per CU review
	Grades 6-12	2 per classroom, or per CU review	2 per classroom, or per CU review

Chapter 6. Design Program

Clark County has been working for the past decade to implement on-street bikeway, sidewalk, and trail projects in order to encourage walking and cycling, improve safety, and improve the quality of active transportation so that it becomes an integral part of daily life. While Clark County is growing rapidly, it also contains a built urban environment, so many future projects will involve retrofitting existing streets and intersections. The county has significant changes in topography, a high demand for on-street parking, a roadway system heavily reliant on arterial roadways, and many other complex situations.

The Clark County Bicycle and Pedestrian Master Plan design program is based on current federal and state bikeway and walkway design guidelines for typical bikeway situations provided in the Washington Department of Transportation *Design Manual*, American Association of State Highway and Transportation Officials (AASHTO) *Guide for the Development of Bicycle Facilities*, the *Manual of Uniform Traffic Control Devices (MUTCD): Part 9 Traffic Controls for Bicycle Facilities*, and United States Access Board *Public Rights-of-Way Accessibility Guidelines (PROWAG)*, 2007. The Clark County Bicycle and Pedestrian Master Plan guidelines use these documents as a baseline for minimum conditions, and are intended to find creative solutions to a wide range of bicycle facility types. These treatments draw upon creative solutions in use in other states as well as European cities. Some of these designs are conceptual at this stage, and must be reviewed further before being applied to actual situations.

Strong design guidelines will allow Clark County to improve the quality of the bicycle network by identifying the highest standard of bicycle safety, comfort, and convenience. This design program also can be used by bicycle and pedestrian committees as a reference when reviewing road and development plans, to ensure adequate consideration of bicycle and pedestrian accommodation.

The following are key principles for this program:

- All roads in Clark County are legal for the use of bicyclists, except limited access interstates which specifically prohibit bicyclists, including I-5 through Vancouver and part of the Lewis and Clark Highway.
- Bicyclists have a range of skill levels, from “Type B/C” inexperienced / recreational bicyclists (especially children and seniors) to “Type A” experienced cyclists (adults who are capable of sharing the road with motor vehicles). These groups are not always

exclusive – some elite level athletes still like to ride on shared-use paths with their families, and some recreational bicyclists will sometimes use their bicycles for utilitarian travel.

- Facilities will be designed for the use of Type “A” cyclists and for Type “B” cyclists to the greatest extent possible. In areas where specific needs have been identified (for example, near schools) the needs of appropriate types of bicyclists will be accommodated.
- Design guidelines are intended to be flexible and can be applied with professional judgment by designers. Specific national and state guidelines are identified in this document, as well as design treatments that may exceed these guidelines.
- Clark County will have a complete network of on-street bicycling facilities to connect seamlessly to the existing and proposed off-street pathways.

National and State Guidelines / Best Practices

The following is a list of references and sources utilized to develop design guidelines for the Roadways to Bikeways Supplemental Design Guidelines. Many of these documents are available online and are a wealth of information and resources available to the public.

- *AASHTO Guide for the Development of Bicycle Facilities*, 1999. American Association of State Highway and Transportation Officials, Washington, DC. www.transportation.org
- *AASHTO Policy on Geometric Design of Streets and Highways*, 2001. American Association of State Highway and Transportation Officials, Washington, DC. www.transportation.org
- *Manual on Uniform Traffic Control Devices (MUTCD)*, latest edition. Federal Highway Administration, Washington, DC. mutcd.fhwa.dot.gov
- *WSDOT Design Manual, Division 15*, latest edition. <http://www.wsdot.wa.gov/Publications/Manuals/M22-01.htm>
- *Bicycle Facility Selection: A Comparison of Approaches*. Michael King, for the Pedestrian and Bicycle Information Center. Highway Safety Research Center, University of North Carolina – Chapel Hill, August 2002 www.bicyclinginfo.org/pdf/bikeguide.pdf
- *Bicycle Parking Design Guidelines*. www.bicyclinginfo.org/pdf/bikepark.pdf
- *City of Chicago Bike Lane Design Guide*. www.bicyclinginfo.org/pdf/bike_lane.pdf
- *The North Carolina Bicycle Facilities Planning and Design Guidelines*, 1994. NCDOT Division of Bicycle and Pedestrian Transportation.

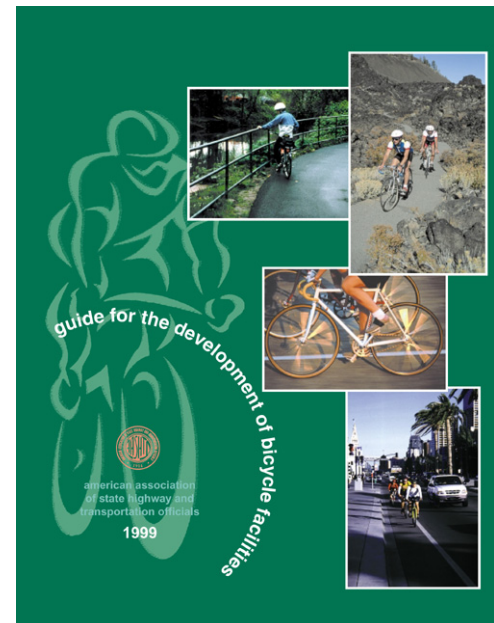

Figure 32. The AASHTO Guide for the Development of Bicycle Facilities

www.ncdot.org/transit/bicycle/projects/resources/projects_facilitydesign.html

- *Wisconsin Bicycle Facility Design Handbook*. 2004. Wisconsin Department of Transportation. www.dot.wisconsin.gov/projects/bike.htm
- *Florida Bicycle Facilities Planning and Design Handbook*. 1999. Florida Department of Transportation. www.dot.state.fl.us/safety/ped_bike/ped_bike_standards.htm#Florida%20Bike%20Handbook
- *Oregon Bicycle and Pedestrian Plan*. 1995 Oregon Department of Transportation. www.oregon.gov/ODOT/HWY/BIKEPED/planproc.shtml
- City of Portland (OR) *Bicycle Master Plan*. 1998. City of Portland (OR) Office of Transportation. www.portlandonline.com/shared/cfm/image.cfm?id=40414
- ITD Manual
- *Public Rights-of-Way Accessibility Guidelines (PROWAG)*, 2007. United States Access Board, Washington, D.C. <http://www.access-board.gov/PROWAC/alterations/guide.htm>

Bicycle Facility Selection Criteria

The appropriate bicycle facility for any particular roadway whether new or existing should be primarily dictated by vehicle volume and speed of the roadway. However, there are no ‘hard and fast’ rules for determining the most appropriate type of facility for a particular location; engineering judgment and planning skills are critical elements of this decision.

A study by the Pedestrian and Bicycle Information Center and Highway Safety Research Center at the University of North Carolina surveyed the various requirements available and provided a best practices approach for providing bicycle facilities. Figure 33 shows a summary of their results, combining bikeway dimension standards for ten different communities in North America.

Average daily traffic (ADT) is presented along the left side of the figure and along the bottom is the speed of travel lane. The different colors represent the type of bikeway facility prescribed given the volume and speed of the travel lane. Depending on the speed and volume characteristics of the roadway, this table indicates the level of separation required for bicycle travel. However, the graphic accounts for only bike lane/shoulders, wide lanes, and normal lanes, which does not cover the range of bikeway facility types currently used throughout the country. Cycle tracks, shared lane markings, and bicycle boulevards are frequently used, and bike lanes can be improved through coloration, buffering, or additional striping.

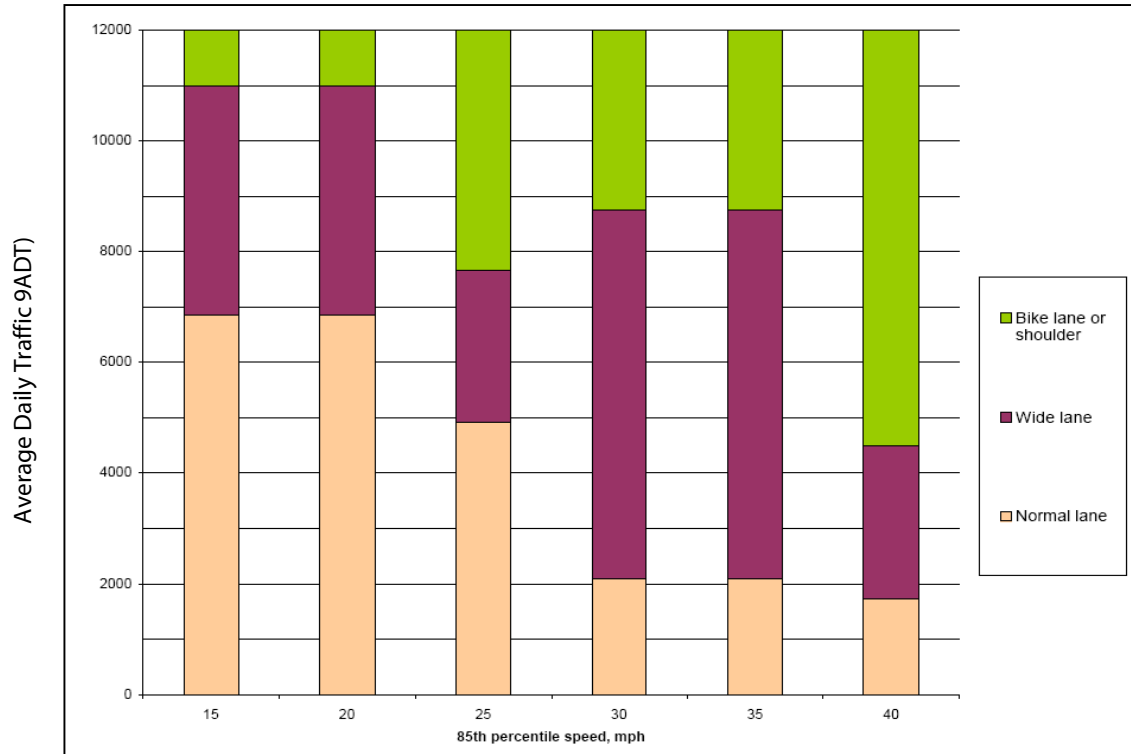

Figure 33. Bicycle Facility Selection Based on Roadway Speeds and Volumes
 Source: Michael King for the UNC-HSRC Pedestrian and Bicycle Information Center

Factors that would increase the need for bike lanes, rather than shoulder bikeways, are shown in Table 17.

Table 17. Factors that Affect the Use of Bike Lanes or Shoulder Bikeways

Increases Need for Bike Lanes		Decreases Need for Bike Lanes	
1. Land Use indicators			
Suburban		Urban Center, CBD	
Buildings set back from roadway (parking lots front street)		Buildings at back of sidewalk	
Long block length		On Street Parking	
2. Traffic speed/volume indicators			
Signal coordination timed at higher than posted speeds		Signal coordination timed at lower than posted speeds	
Peak Hourly Traffic Volume > 10%			
3. Roadway characteristics			
Wide roadway / multiple travel lanes		Steep grades: downhill	
Steep grades: uphill			
4. Bicycling demand indicators			
Popular Route to School			
Provides continuity of bike lanes, routing or trail			

Source: Oregon Bicycle and Pedestrian Plan, 2008 Draft Update

Matrix of Best Practices

The following section presents a series of matrixes that outline best practices related to bicycle and pedestrian facility standards and related facilities and design guidelines. These are intended to be developed into actual guidelines by Clark County staff in coordination with the Bicycle and Pedestrian Advisory Committee and individual jurisdictions.

Pedestrian Design Program

Table 18. Sidewalk Issues

Issue	Solution	Source/Example
Sidewalk Obstructions		
Structural obstructions	Place obstructions between sidewalk and roadway to create a buffer	Can include sign posts, utility and signal poles, mailboxes, fire hydrants and street furniture
Parked vehicles overhanging sidewalk	Place wheelstops in parking area	
Sidewalks not feasible/appropriate (due to site conditions, e.g. trees, walls, hillsides etc.)	Soft Paths	
	Colored Shoulders	
	Install a retaining wall along a hillside	
Street Corners		
Cluttered/low visibility street corner	Define an Obstruction-Free Area	
	"No Private Use" Area	Prohibit private temporary uses including street vendors, sidewalk cafes, A-boards, newspaper vending machines, 1.5 m (5'-0") back from extension of property line
Inadequate Pedestrian Area at Street Corners	Reduce the curb radius	
	Use a lane for parking or bicycles that reduces the "effective" curb radius	
Cost/operational conditions preclude the use of perpendicular curb ramps	Construct diagonal Curb Ramps	

Table 19. Pedestrian Crossing Issues

Issue	Solution	Source/Example
Accessibility		
Sidewalk inaccessible from the roadway level of the crosswalk	Curb Ramps	
Wheelchair has difficulty accessing curb ramp	Perpendicular Curb Ramps	
Visually-impaired pedestrian entering the street or intersection	Tactile warnings (Truncated Domes)	Complex intersections, roundabouts, wide intersections, open plazas are areas where raised tactile devices could be considered
Visually-impaired pedestrian entering the street or intersection	Grooves	Indentations at the top of curb ramps that can be detected by canes in contact with the sidewalk.
	Audible Pedestrian Traffic Signals Crosswalk Pavement Markings	
Safety/Visibility		
Parked cars blocking sightlines	Parking control	
Vehicles entering the pedestrian right of way	Safety Barrels and Bollards	
Pedestrians difficult to see at a crossing	Curb Extensions	
Not clear where pedestrians should cross traffic	Crosswalk Pavement Markings	
Motorists not yielding at crosswalk	Crosswalk Pavement Markings	
	Raised Crosswalk	
	In-Street Yield to Pedestrian Signs	
	In-Pavement Crosswalk Lights Flashing Yellow Beacons	
Mid-Block Crossings		
High pedestrian volume at a mid-block location	Pedestrian-activated pedestrian-only traffic control signal	Manual on Uniform Traffic Control Devices (4C-5)
Pedestrians crossing mid-block	Median Refuge Island	
	Mid-block Crosswalk	Always indicated with pavement markings and warning signs
	Pelican Signal	Pedestrian Light Control Activated crossing
	Puffin Signal Hawk Signal	Pedestrian User Friendly Intelligent High-Intensity Activated Crosswalk

Issue	Solution	Source/Example
Dangerous Intersections		
Long crossing distance for pedestrians	Curb Extensions	Use with right turn slip lanes, modern roundabouts, "T" intersections between right-turning and left-turning travel lanes, etc.
	Median Refuge Island	
	Porkchop Refuge Island	
	Pedestrian Countdown Signals	
Especially dangerous pedestrian crossing	Grade separated crossing No pedestrian crossing	Examples include crossing freeway /waterway
Conflicting movements of pedestrians and vehicles	Leading Pedestrian Interval	Dedicated pedestrian-only phase of the signal
Vehicles encroaching into pedestrian crossing area	Stop and Yield Lines	
School-Zone Crossings		
Need for increased safety	School Zone Yellow Crosswalks	
	Flashing Yellow Beacons	
	Grade-Separated Overcrossings	
Other Pedestrian Crossing Issues		
Infrequent pedestrian crossings at a signalized intersection	Pedestrian Push Buttons	
High volume of pedestrians	Pedestrian Countdown Signals	
Grade changes from a pedestrian path	Raised Crosswalk or Raised Intersection	
Lack of information during pedestrian signal phase	Pedestrian Signal Indication ("Ped Head")	
Long pedestrian delay at crosswalk	Adjust signals at nearby intersections	
	Lighted call button to reassure pedestrians their call has been received	

Table 20. Bike Lanes

Issue	Solution	Source/Example
Installing Bike Lanes		
Insufficient space to stripe bike lanes on both sides of the street	Uphill bike lanes - lanes added to uphill side only	Portland, OR, Seattle, WA, and Madison, WI
Inadequate space for bike lanes	Shoulder Widening	Most feasible on streets lacking adjacent curbs or corridors with limited development immediately adjacent to the street.
	Reducing Travel Lane or On-Street Parking Lane Widths	Prior to implementing this measure, conduct a traffic analysis to identify overall transportation impacts, including transit and emergency vehicle circulation issues.
	Road Diet	Removing Travel Lanes: SF (Valencia Street), Santa Monica (Main St)
	Removing On-Street Parking	gauge demand with study
	Wide Curb Lanes	In addition to adjacent vehicle traffic, curb gutter pans, raised reflectors and drainage grates influence the usable width for bicyclists. Wide curb lanes should be at least 14 feet wide but no wider than 16 feet. They are less desirable due to motorists passing bicyclists in the same travel lane.
	Shared Lane Markings ("Sharrows")	San Francisco, CA, Denver, CO, Paris, France, Gainesville, FL
Peak hour parking restrictions prevent bike lanes on arterials	Floating or Off-Peak Bicycle Lanes	Designates a single lane (14-16 feet wide) to function as a parking lane, a designated bike lane, and then both, depending on the time of day. E.g. San Francisco, CA (Embarcadero)
Bike Lane Conflicts		
Transition from a left side bike lane to a right side bike lane.	Bike Box	Eugene, OR, Cambridge, MA, European cities
	Two Bike Lane Transition Option	Portland, OR
Allowing bicycles to access a bicycle boulevard or a designated bike route	Bike-Only Left-Turn Pockets: Scenario 1	Portland, OR
Direct access needed to a key destination	Contraflow Bicycle Lanes	Portland, OR, Madison, WI, San Francisco, CA and Cambridge, MA
Infrequent driveways on the bike lane side	Contraflow Bicycle Lanes	Portland, OR, Madison, WI, San Francisco, CA and Cambridge, MA
Conflicts with parked cars	Minimize parking lane width.	Research suggests that vehicles park closer to the curb in narrower parking lanes. Parking lanes can be reduced to 2.1 m (7 ft), and in some cases, to 1.9 m (6.5 ft).
	Marked parking spaces with cross hatches	indicating the parking lane limits may help guide drivers closer to the curb

Issue	Solution	Source/Example
	Bike route stencils	Educate drivers on narrow roadways with on-street parking to expect bicyclists in travel lane.
Conflicts with parked cars	Avoid angled parking	Require back-in parking; e.g. Seattle, WA
	Shared Lane Markings ("Sharrows")	Treatment to ensure that bicyclists ride outside of the "door zone" of parked cars
	Diagonal Striping Buffer	Minneapolis, MN
Parked cars "dooring" bicyclists	Left Side Bike Lanes (on one-way streets)	
Cars driving in bicycle lanes	Raised Bike Lanes	The height of the raise should not be substantial, and the edge should be clearly marked and gradual, to prevent accidents
	Additional striping treatments	To minimize confusion and clearly depict the lane for bicycle travel
Motor vehicle and bicycle conflict points	Colored Bike Lanes	
Desire to separate bicycles from pedestrians and motorists	One-way Bike Paths (Cycle Tracks)	Work best along roadways with few street and driveway intersections (minimizing occurrences of parked or standing vehicles blocking the bikeway), when adequate intersection treatments exist to address bicyclist/motorist conflicts,
	Optimize low volume streets for bicycles	Bicycle Boulevards

Table 21. Bicycle Boulevards

Issue	Solution	Source/Example
Installing Bicycle Boulevards		
High volume of bike and auto traffic	"Share the road" warning signage	
Cyclists or motorists unaware that a street is a bicycle boulevard	Directional Pavement Markings Wayfinding signage	Portland, OR Signage
Frequency of stop signs limits ease of use	Place stop signs on cross-streets approaching a bicycle boulevard.	This treatment should be used judiciously to minimize the potential for increasing vehicle speeds on the bicycle boulevard.
Bicycle Boulevard Crossings		
Bicycle boulevard crossing signalized intersection	In-pavement bicycle loop detectors, with a bicycle stencil indicating where the cyclist should place their bike. Bicyclist activation buttons	
Bicycle boulevard crossing a major street at an unsignalized intersection	Half Signals Medians/Refuge Islands	Include pedestrian and bicycle activation buttons, bicycle loop detectors Can be used to simplify bicyclist and pedestrian crossings on major street.

Table 22. Crossing/Intersection Issues

Issue	Solution	Source/Example
Left Turns		
Difficult left turn movement	Bicycle Boxes	Cambridge, MA, Portland and Eugene, OR
	Bicycle Left-turn Pocket Lane	Standard-width bicycle lane adjacent to the left-hand turn lane in order to reduce conflicts with turning vehicles. The Bicyclists Merging sign may be placed on the right side of the road before the left-side turn pocket. Potential applications include low-moderate speeds, on lower volume arterials and collectors, and heavy vehicular left-hand turning movements. e.g. San Francisco, CA and Flagstaff, AZ
High demand for bicycle left turn movements	Left Side Bike Lanes (on one-way streets)	Sacramento, San Francisco Minneapolis, Madison, Wisconsin and New York City
Bike lane or route jogs across a large street	Mid-Block Bicycle Turning Lane	

Issue	Solution	Source/Example
Crossing Right-Turn Lane		
Cars making a right hand turn at an intersection not seeing cyclists	Bicycle Boxes	Cambridge, MA, Portland and Eugene, OR
Bike lane crossing a right-turn-only lane	Drop all delineation of the bike lane at the approach of the right-turn lane Shared bicycle/right-turn lane, with the bike lane to the left of the right-hand turn lane	San Francisco, Eugene, Oregon, and Kona, Hawaii
Double right-turn lanes	Shared Bicycle/ Double Right-Turn Lane, with the bike lane to the left of the right-hand turn lane, coloration optional.	Uses pavement markings and signage to encourage bicyclists to maneuver away from curb lane and into through/right-turn lane. Portland, OR places blue bike lane between the curb lane and second right-turn lane, and continues the blue bike lane through the intersection conflict area.
Lane merging from the right	The bike lane should turn and encourage the cyclist to cross at an angle, minimizing their exposure.	
Other Bicyclist Crossing Issues		
Complex intersection	Bike Lane through a Complex Intersection	Paris, France
Railroad crossings	90-degree crossings	Prevent the wheels of bicycles, wheelchairs, strollers and other devices from becoming trapped in the flangeway.
	Additional shoulder width	Enables a cyclist to cross at a safer angle. train speeds are low,
	Commercially-available compressible flangeway fillers	Where train speeds are low and other treatments are not feasible
Need for increased visibility of cyclists at busy intersection	Bicycle Boxes	Cambridge, MA, Portland, OR and Eugene, OR
Cyclist Safety Considerations		
Rumble strips endangering cyclists	Shoulder rumble strips should not be used	
Bicyclists breathing exhaust at intersection	Bicycle Boxes	
Drivers unaware of cyclists	Signage	
Providing for bikes in rural areas	Shoulder bikeways	Paved roadways with striped shoulders wide enough for bicycle travel, shoulder bikeways often, but not always, include signage alerting motorists to expect bicycle travel along the roadway.

Table 23. Safety Design Guidelines

Issue	Solution	Source/Example
High traffic speeds	Chicanes	A series of curb extensions or narrowings that create an S-shaped route, causing traffic to slow down; e.g. Milvia Street in North Berkeley
	Speed Humps	SE Lincoln Street in Portland
	Traffic Calming Circles	SE Lincoln Street in Portland
	Curb Extensions	Create a visual “pinch point” for approaching motorists. Curb extensions should be designed with sufficient radii to accommodate the turning movements of snow plows, school buses and emergency vehicles.
	Medians/Refuge Islands	Create a visual “pinch point” for approaching motorists.
	Mini Traffic Circles	Raised or delineated islands placed at intersections, reducing vehicle speeds through tighter turning radii and narrowed vehicle travel lanes. Mini traffic circles can also include a paved apron to accommodate the turning radii of larger vehicles like fire trucks or school buses.
	Speed Humps	Bike
	Speed Feedback Signs	Set to activate only during select times of day, such as during a school commuter period, to maximize effectiveness
Shared bikeway with high auto traffic volume	Warning Signs	Should advise motorists to the presence of cyclists.
	Speed Humps	
Want to discourage through vehicle travel on a street when a parallel through route exists	Choker Entrances	Intersection curb extensions or raised islands allowing full bicycle passage while restricting vehicle access to and from a bicycle boulevard.
	Traffic Diverters	Similar to choker entrances, traffic diverters are raised features directing vehicle traffic off the bicycle boulevard while permitting through bicycle travel.
	Street Closures/Diverters	

Table 24. Bicycle Parking Design Guidelines

Issue	Solution	Source/Example
Accommodating visitors, customers, messengers and others expected to depart within two hours	Short-term bicycle parking	Should be at least 6' by 2.5' with 7' overhead clearance, and securely anchored to the surface or structure.
Accommodating employees, students, residents, commuters, and others expected to park more than two hours	Long-Term Bicycle Parking	This parking is to be provided in a secure, weather-protected manner and location. Examples include lockers, check-in facilities, monitored parking, restricted access parking, and personal storage.
No sidewalk space for racks	clustered racks in a car parking space	Should be protected by bollards or curbs
	racks installed on sidewalk curb extensions	where adequate sight distance can be provided
Bicycle rack visibility	minimum height of 33 inches	To increase visibility to pedestrians
	indicated or cordoned off by visible markers	To increase visibility to pedestrians
	signs at least 12 inches square	The sign should give the name, phone number, and location of the person in charge of the facility, where applicable.
	Lighting	Not less than one foot-candle illumination at ground level.
Frequency of Bike Racks	Two or more racks should be installed on each side of each block.	Popular retail areas. This does not eliminate the inclusion of requests from the public which do not fall in these areas. Areas officially designated or used as bicycle routes may warrant the consideration of more racks.
Accessibility	Curb Ramps	Where access is by sidewalk or walkway, curb ramps should be provided where appropriate and ADA compliant.
	Parking facilities intended for employees	Locate near employee entrance. Convenience should be balanced against the need for security if the employee entrance is not in a well traveled area.
	Parking facilities for customers or visitors	Locate near the main public entrances.
	Location of Bike Racks within Buildings	Provide bike racks within 50 feet of the entrance. Where a security guard is present, provide racks behind/within view of a security guard. Location should be outside the normal flow of pedestrian traffic.

Issue	Solution	Source/Example
	<p>Location of Bike Racks near Transit Stops</p>	<p>To prevent bicyclists from locking bikes to bus stop poles, creating access problems for transit users, racks should be placed in close proximity to transit stops in locations where there is a demand for short-term bike parking.</p>
<p>Need for additional security</p>	<p>Surround clustered racks by a fence</p> <p>Place racks in a locked room</p> <p>Place racks within view or within 100' of attendant or security guard</p> <p>Place racks in a location that is visible from employee work areas.</p> <p>Place racks in an area that is monitored by a security camera</p>	<p>The attendant can often share this duty with other duties to reduce or eliminate the cost of labor being applied to the bike parking duties.</p>
<p>Old/Inadequate existing racks</p>	<p>Bike Rack Retrofit Program</p>	<p>Conduct bicycle parking audits to assess the bicycle parking availability and access and add additional bicycle racks where necessary.</p> <p>Use bicycle and pedestrian counters to track bicycle parking use.</p>

Table 25. Trail Design Guidelines

Issue	Solution	Source/Example
Accessibility		
Improve access to a trail	Trailheads	<p>Provide essential access to the trail system and include amenities like parking for vehicles and bicycles, restrooms (at major trailheads), and posted maps. A central information installation also helps users find their way and acknowledge the rules of the path.</p> <p>See Vancouver-Clark Parks Bicycle and Trail Plan and Vancouver Comprehensive Plan.</p>
Provision of amenities on a path		
	Interpretive Installations Water Fountains and Bicycle Parking Pedestrian-Scale Lighting and Furniture	<p>Providing benches at key rest areas and viewpoints encourages people of all ages to use the pathway by ensuring that they have a place to rest along the way.</p>
	Maps and Signage	<p>Informational kiosks with maps at trailheads and other pedestrian generators can provide enough information for someone to use the network with little introduction – perfect for areas with high out-of-area visitation rates as well as the local citizens.</p>
	Art Installations	<p>Many pathway art installations are functional as well as aesthetic, as they may provide places to sit and play on.</p>
	Landscaping	<p>Trees can provide shade from heat and also provide protection from rain.</p>
	Restrooms	
Access Management		
Unwanted vehicle access on path	<p>Utilize landscaping to define the corridor edge and path, including earth berms and large boulders.</p> <p>Use bollards at intersections</p> <p>Pass a motorized vehicle prohibited ordinance and sign the path.</p> <p>Create a Path Watch Program and encourage citizens to photograph report illegal vehicle use of the corridor.</p> <p>Lay the trail out with curves that allow bike/ped passage, but are uncomfortably tight for automobile passage.</p>	

Issue	Solution	Source/Example
Trespassing on path	<p>Clearly distinguish public path right-of-way from private property through the use of vegetative buffers and the use of good neighbor type fencing.</p> <p>Post path rules that encourage respect for private property.</p>	
Private use of corridor	<p>Attempt to negotiate win/win solutions with property owners.</p> <p>Eliminate where detrimental impact to path cannot be reasonably ameliorated.</p>	
Crime		
Litter and dumping	<p>Post path rules encouraging pack-it-in/pack-it-out etiquette.</p> <p>Place garbage receptacles at trailheads.</p> <p>Strategically-placed lighting, utilizing light shields to minimize unwanted light in adjacent homes.</p> <p>Manage vegetation within the right-of-way to allow good visual surveillance of the path from adjacent properties and from roadway/path intersections.</p> <p>Encourage local residents to report incidents as soon as they occur.</p> <p>Remove dumpsites as soon as possible.</p>	
Crime	<p>Manage vegetation so that corridor can be visually surveyed from adjacent streets and residences.</p> <p>Select shrubs that grow below 3 ft in height and trees that branch out greater than 6 ft in height.</p> <p>Place lights strategically and as necessary.</p> <p>Place benches and other path amenities at locations with good visual surveillance and high activity.</p> <p>Provide mileage markers at quarter-mile increments and clear directional signage for orientation.</p> <p>Create a "Path Watch Program" involving local residents.</p> <p>Proactive law enforcement. Utilize the corridor for mounted patrol training.</p>	
Vandalism	<p>Select benches, bollards, signage and other site amenities that are durable, low maintenance and vandal resistant.</p> <p>Respond through removal or replacement in rapid manner.</p> <p>Keep a photo record of all vandalism and turn over to local law enforcement.</p>	

Issue	Solution	Source/Example
	<p>Encourage local residents to report vandalism.</p> <p>Create a Trail Watch Program; maintain good surveillance of the corridor.</p> <p>Involve neighbors in path projects to build a sense of ownership.</p> <p>Place amenities (benches, etc.) in well used and highly visible areas.</p>	
Safety		
Safety on Path	<p>The most effective and most visible deterrent to illegal activity on Clark County’s path system will be the presence of legitimate path users. Getting as many “eyes on the corridor” as possible is a key deterrent to undesirable activity.</p> <p>Provide good access to the path</p> <p>Good visibility from adjacent neighbors</p> <p>High level of maintenance</p> <p>Programmed events</p> <p>Community projects- Ideas for community projects include volunteer planting events, art projects, interpretive research projects, or even bridge building events. These community projects are the strongest means of creating a sense of ownership along the path that is perhaps the strongest single deterrent to undesirable activity along the path.</p> <p>Encourage safe sharing of the path by multiple users by posting etiquette and behavior guidelines.</p> <p>Adopt-a-Path Program</p> <p>Path Watch Program</p>	
Path crossing a street	<p>Marked/Unsignalized Crossings</p> <p>Route Users to Existing Signalized Intersection - perhaps with the use of loop detectors</p> <p>Signalized/Controlled</p> <p>Grade-separated crossings - Grade-separated crossings may be needed where existing bicycle/pedestrian crossings do not exist, where ADT exceeds 25,000 vehicles, and 85th percentile speeds exceed 45 MPH. Safety is a major concern with both overcrossings and undercrossings. In both cases, trail users may be temporarily out of sight from public view and may have poor visibility themselves.</p>	
Trailhead safety	<p>Clearly identify trailhead access areas.</p>	

Issue	Solution	Source/Example
Maintenance		
	Trail inspections	Seasonal –beginning and end of summer
	Trail signage replacement	1-3 years
	Trail site furnishings; replace damaged components	As needed
Amenities	Trail fencing repair	Inspect monthly for holes and damage, repair immediately
	Trail pavement markings replacement	1-3 years
	Trail lighting repair	Annually
Pavement		
	Trail pavement sweeping/blowing	As needed; before high use season
	Trail pavement sealing; pothole repair	5-15 years
	Trail major damage response (fallen trees, flooding)	Schedule based on priorities
Landscaping		
	Trail introduced tree and shrub plantings, trimming	1-3 years
	Trail shrub/tree irrigation for introduced planting areas	Weekly during summer months until plants are established
	Trail shoulder plant trimming (weeds, trees, branches)	Twice a year; middle of growing season
Culverts		
	Trail culvert inspection	Before rainy season; after major storms
	Trail culvert inlet maintenance	Inspect before onset of wet season
	Trail waterbar maintenance (earthen trails)	Annually
Trash/graffiti		
	Trail trash disposal	Weekly during high use; twice monthly during low use
	Trail litter pick-up	Weekly during high use; twice monthly during low use
	Trail graffiti removal	Weekly; as needed
Other Trail Issues		
Privacy of property owners adjacent to path	Encourage the use of neighborhood friendly fencing and also planting of landscape buffers. Clearly mark path access points. Post path rules that encourage respect for private property. Strategically placed lighting.	
Local on-street parking near a path	Post local residential streets as parking for local residents only to discourage path user parking. Place "no outlet" and "no parking" signs prior to path access points.	

Table 26. Maintenance and Street Closures Design Guidelines

Issue	Solution	Example
<p>Traffic Diversion or street closures on sidewalks</p>	<p>Pedestrians should not be led into conflicts with work site vehicles, equipment, moving vehicles, or temporary construction signage.</p>	
	<p>Provide safe, accessible, convenient path for pedestrians</p> <p>Provide alternate circulation path</p>	<p>Should replicate as nearly as practical the most desirable characteristics of the existing sidewalk(s) or a footpath(s).</p> <p>Should be parallel to the disrupted pedestrian access route, be located on the same side of the street, and accommodate the disabled. It should also include warning signage and a protective barricade if necessary.</p>
<p>Bike travel through construction zones</p>	<p>Efforts shall be made to re-create the bike lane to the left of the construction zone</p>	<p>The recommended minimum width of a bike lane in a construction zone is 5-feet.</p>
	<p>Provide standard wide travel lane through construction area</p>	<p>If insufficient space exists to provide a bike lane adjacent to the construction zone.</p>
	<p>Steel plating used in the roadway must have a non-skid surface.</p>	
<p>Construction Zone Signage</p>	<p>The following MUTCD signs should be used: W21-4A Road Work Ahead; W20-5 Right Lane Closed; W4-2 Lane Shift, Left Sign; W11-1 Bicycle Warning Sign; W16-1 Share The Road</p>	
	<p>Place signage where it does not obstruct the path of bicycles or pedestrians, including bicycle lanes, wide curb lanes, or sidewalks.</p>	
	<p>Signage related to bicycle travel shall be included on all bikeways where construction activities occur.</p>	<p>In areas where there are grades, so as not to encroach onto a bike lane facility</p> <p>Signage shall also be provided on all other roadways.</p>
<p>Cyclists riding in street to avoid debris in bike lane or shoulder</p>	<p>Establish a seasonal sweeping schedule that prioritizes roadways with major bicycle facilities and routes</p> <p>Sweeping walkways and bikeways whenever there is an accumulation of debris on the facility</p>	

Issue	Solution	Example
Cyclists riding in street to avoid debris in bike lane or shoulder	<p>In curbed sections, sweepers should pick up debris; on open shoulders, debris can be swept onto gravel shoulders</p> <p>Paving gravel driveway approaches to reduce loose gravel on paved roadway shoulders</p> <p>Providing extra sweeping in the fall in areas where leaves accumulate in bike lanes</p>	
Cyclists avoiding roads with uneven surfaces	<p>On all routes identified in the Plan, the smallest possible chip should be used for chipsealing the bike lanes and shoulders</p> <p>On new construction, the finished surface of bikeways should not vary more than ¼ inch from the lower edge of an 8' long straight edge when laid on the surface in any direction.</p> <p>The surface of a roadway open to bicycle travel should be smooth, free of potholes, and the pavement edge uniform.</p> <p>Pavement shall be maintained so ridge buildup does not occur at the gutter-to-pavement transition or adjacent to railway crossings.</p> <p>Inspect the pavement 2-4 months after trenching construction activities are completed to ensure that excessive settlement did not occur.</p>	
Trenching and plate use disrupting cycling	<p>Steel plates used as a temporary measure during construction activities shall not have a vertical edge greater than ¼ inch without a temporary asphalt lip</p> <p>Consider using non-skid steel plates with no raised steel bar on top.</p> <p>Wherever possible, use in-laid steel plates that are flush with the surrounding pavement surface</p> <p>Steel plates shall be used only as a temporary measure during construction and shall not be used for extended periods of time.</p>	<p>To accommodate bicyclists riding over them.</p> <p>In order to minimize or eliminate the vertical transition between plates and the pavement for bicyclists.</p>
Potholes and other uneven surfaces around gutters	<p>Gutter-to-pavement transitions should have no more than a ¼ inch vertical transition.</p>	

Issue	Solution	Example
disrupting cycling	Pavement transitions should be examined during every roadway project for new construction, maintenance activities, and construction project activities that occur in streets.	
Raised items on a roadway presenting a hazard to bicyclists	<p>Require that all new drainage grates be bicycle-friendly.</p> <p>Temporary correction of welding thin metal straps across the grates perpendicular to the drainage slots</p> <p>A program to inventory all existing drainage grates should be implemented.</p> <p>Utility covers should be adjusted flush with the street surface</p> <p>Raised pavement markings (e.g., reflectors and truncated domes) should not be used to delineate bicycle lanes</p>	<p>These include grates that have horizontal slats on them so that bicycle tires do not fall through the vertical slats.</p> <p>(four to six inches apart, center-to-center spacing) should be considered is grate bicycle-unfriendly</p> <p>Grates that are not bicycle-friendly should be replaced or reset countywide.</p>
Pavement overlay project disrupts cycling	<p>Extend the overlay over the entire roadway surface to avoid leaving an abrupt edge</p> <p>May be appropriate to stop at the shoulder or bike lane stripe, provided no abrupt ridge remains</p> <p>After overlays, raise inlet grates, manhole and valve covers to within ¼ inch of the pavement surface</p> <p>In curbed sections, maintain a 7 inch (min. 5 inch) curb exposure for pedestrian safety</p> <p>Where the existing roadway surface is ground out, grind the entire surface</p> <p>Pave gravel driveways and approaches 15 feet from the edge of pavement</p> <p>Sweep the project area after overlay.</p>	<p>If extending the overlay is not possible, and there is adequate shoulder or bike lane width</p> <p>To avoid an exaggerated crown and a steep slope at crosswalks, creating difficulties for the disabled</p> <p>To prevent gravel from spilling onto shoulders or bike lanes</p>
Regulatory and wayfinding signage maintenance	<p>Check at beginning and end of summer for signs of vandalism, graffiti, or normal wear.</p> <p>Signage should be replaced along the network on an as-needed basis.</p>	Often 1-3 years

Issue	Solution	Example
	A regularly scheduled check on the status of signage should be performed with follow-up as necessary.	
Other regular maintenance	Fencing repair	Inspect monthly for holes and damage, repair immediately
	Pavement markings replacement	1-3 years
	Lighting repair	Annually
	Introduced tree and shrub plantings, trimming	1-3 years
	Shrub/tree irrigation for introduced planting areas	Weekly during summer months until plants are established
	Shoulder plant trimming (weeds, trees, branches)	Twice a year; middle of growing season
	Major damage response (fallen trees, washouts, flooding)	Schedule based on priorities
	Culvert inspection	Before rainy season; after major storms
	Maintaining culvert inlets	Inspect before onset of wet season
	Waterbar maintenance (earthen trails)	Annually
Trash disposal	Weekly during high use; twice monthly during low use	
Litter pick-up	Weekly during high use; twice monthly during low use	

Chapter 7. Education and Outreach Strategies

This chapter outlines the education and outreach strategies to encourage walking and bicycling in Clark County and its cities. It describes recommendations for potential encouragement, education and enforcement programs that have been successful in other communities.

Existing Education and Outreach Efforts

Education and Outreach programs in Clark County are designed to raise awareness of walking and bicycling; connecting current and future users to existing resources; educating them about their rights and responsibilities; and encourage residents to walk and bicycle more often. Key target audiences include drivers; current and potential (interested) cyclists and pedestrians; students, children and families; school personnel; and employees (through employer programs). While many of the recommended actions in this section are not directly under Clark County's purview, it is helpful for the County to recognize the importance of support programs for bicyclists and pedestrians. Education, encouragement and enforcement programs enable pedestrians and cyclists to safely and easily use the bicycle network.

Existing Clubs, Organizations, and Racing Teams

Several clubs have activities aimed at encouraging women riders and young racers. A few of these classes and rides are aimed at inexperienced riders, but most are designed for experienced road riders. For example, the Vancouver Bicycle Club holds several bicycle rides a week. Once a week they hold bicycle rides for women who are beginners at cycling.

Several of these clubs and organizations are based in Portland, Oregon, but also serve residents. Many organizations are available within Clark County that promote walking for health, transportation, and recreation. These advocacy groups can provide valuable support for education, encouragement, and enforcement programs targeting pedestrians.

Bicycling Organizations

- Clark County Bicycle Advisory Committee
- Bicycle Alliance of Washington: www.bicyclealliance.org/
- Bike Buddy Program:
www.bicyclealliance.org/commute/bikebuddy.html
- Bicycle Transportation Alliance: www.bta4bikes.org/
- League of American Bicyclists: <http://www.bikeleague.org/>

- Bike Mel: <http://bikemevanancouver.blogspot.com/>

Bicycling Clubs and Racing Teams

- Vancouver Bicycle Club: <http://www.vancouverbicycleclub.com/>
- Ride Around Clark County (RACC) annual ride
- North River Racing Team: <http://www.northriverracing.com/>
- Shift: <http://www.shift2bikes.org/>
- Portland Wheelmen Touring Club: <http://www.pwtc.com/>
- Clark College Bike Club:
http://www.clark.edu/student_life/clubs/list.php

Pedestrian Organizations

- Volksmarchers/International Discovery Walk:
<http://www.discoverywalk.org/>
- Vancouver-Clark Parks and Recreation:
<http://www.cityofvancouver.us/parks-recreation/index.asp>
- Washington State Center for Safe Routes to School:
<http://www.saferoutes-wa.org/>
- Friends of Clark County Active Transportation:
<http://www.clarkfriends.org/>
- Transportation Choices: <http://www.transportationchoices.org>
- City of Vancouver Transportation Services:
<http://www.cityofvancouver.us/departments.asp?deptID=10431>
- Feet First – <http://www.feetfirst.org>
- National Center for Safe Routes to School:
<http://www.saferoutesinfo.org/index.cfm>
- America Walks: <http://www.americawalks.org>
- Feet First: <http://feetfirst.info>

Existing Resources

The City of Vancouver has a website devoted to bicycling, which provides information about Vancouver's designation as a Bronze-level Bicycle Friendly Community, as well as a Vancouver bike map and a Vancouver bicycle resource card, which has contact information for emergency and maintenance phone numbers, and transit information.⁴ It also provides information about the bicycle planning and bicycle parking programs.

In addition, the Clark County Smart Commuter web site provides information about bicycling in the County, including tips for bicycle commuting such as appropriate gear, lighting, and route choice. Several



Figure 34. The Clark College Bicycle Club, circa 2009.

⁴ <http://www.cityofvancouver.us/bike.asp?menuid=10466&submenuid=23027>

maps are available on this site, and it provides information about combining bicycle trips with transit in the County.

Other resources include the following:

- Clark County Bicycle Map: <http://www.clark.wa.gov/public-works/bikepath/Bike2007.pdf>
- Carpool Match NW: <http://www.carpoolmatchnw.org/>
- Bike & Bus and Bike & Lock...It's a travel combination that makes sense! <http://www.c-tran.com/bike-friendly.html>
- Wheel Options: <http://wheelloptions.org/>
- Drive Less. Save More. Website: <http://www.driveless.savemore.com/>
- Washington State Ridesharing Organization: <http://www.wsro.net/>
- WSU Vancouver cougar trails map of jogging and paved trails through the campus: <http://www.vancouver.wsu.edu/adm/fo/psafety/WSUV%20Campus%20Trail%20Map.pdf>
- Clark County Walkaround Guide (published by Friends of Clark County Active Transportation)
- Walk There! 50 Treks in and Around Portland and Vancouver (published by Metro)
- Safe Routes to School: www.saferoutes-wa.org/
- C-TRAN: <http://www.c-tran.com/>

Program Recommendations

During the plan update process, staff reviewed 17 outreach programs used throughout the country and internationally to support walking and bicycling. The project advisory committee endorsed staff recommendations for priorities that would most benefit pedestrian and bicyclists in Clark County and encourage nonmotorized trips. Recommended programs include:

- Revising the Bicycle and Pedestrian Advisory Committee
- Create a School Education/Encouragement Program
- Establish 'Clarklovia' or Ride (and Walk) the Drive
- Develop an East County Scenic Tour
- Improve communications between Community Planning, Engineering, and Operations

These recommended programs are discussed in greater detail following.

Revising the Bicycle and Pedestrian Advisory Committee

Official Bicycle and Pedestrian Advisory Committees (BPAC) advise cities, counties and states on technical issues related to walking and bicycling. Clark County currently has a bicycle-only committee.

A BPAC usually is composed of citizen volunteers appointed by the mayor or council. In some jurisdictions, one committee is formed that considers bicycle, pedestrian and/or traffic safety issues. A bicycle/pedestrian advisory committee is a strategic body dedicated to understanding the specific needs and issues of bicycles and pedestrians. The committee comments on transportation planning policy from a unique perspective. The creation of an official committee will make decision makers immediately aware of the importance of bicycle and pedestrian issues

Common charges of BPACs include some or all of the following:

- Review and provide citizen input on capital project planning and design as it affects bicycling and walking (e.g., corridor plans, street improvement projects, signing or signal projects, and parking facilities)
- Review and comment on changes to zoning, development code, comprehensive plans, and other long-term planning and policy documents
- Participate in the development, implementation and evaluation of Bicycle and Pedestrian Master Plans and standards
- Provide a formal liaison between city government, staff, and the public
- Develop and monitor goals and indices related to walking and bicycling in the jurisdiction
- Promote bicycling and walking, including bicycle and pedestrian safety and education

Because BPAC members are volunteers, it is essential to have strong staffing supporting the committee in order for it to be successful. An agency staff person (ideally a Bicycle and Pedestrian Coordinator) should be formally assigned to the BPAC, and who should take charge of managing the application process, facilitating agendas and minutes, scheduling meetings, bringing agency issues to the BAC, and reporting back to the agency and governing body (such as Council) about the BAC's recommendations and findings.



Figure 35. Students participate in a walkabout to evaluate pedestrian conditions.

Create a School Education/Encouragement Program

Helping children walk and bicycle to school is good for children’s health and can reduce congestion, traffic dangers and air pollution caused by parents driving children to school. Robust Walk Routes to School programs address all of the “Five E’s” (Engineering, Education, Encouragement, Enforcement, and Evaluation).

Clark County should build on successful SR2S programs found at both Washington and Daybreak elementary and primary schools. The county should work with school districts to implement the first phase of a school education and encouragement program. This phase will use a walkabout (also known as a **bicycle and pedestrian audit**) to assess walking and biking conditions of streets adjacent to elementary schools. Parents, students, neighbors, and city planners and/or traffic engineers should be invited to join in the walkabout. Safety concerns, issues, and ideas should be recorded.

After the bicycle and pedestrian audit is conducted, **parent maps** for each elementary school showing recommended routes to reach school, along with high-traffic intersections and routes to avoid, should be produced and distributed.

As a final step, an **initial infrastructure improvement plan** should be produced for each elementary school, including cost estimates and a prioritized project list. This infrastructure improvement plan will serve as a blueprint for future investments, and can be used to apply for further grant funding.

The Portland Safer Routes to School Program is a model program that provides good resources on its website:
www.trans.ci.portland.or.us/saferoutes/

Establish a ‘Clarklovia’ or Ride (and Walk) the Drive

The Ciclovía or Sunday Parkway is a great opportunity to engage residents of all ages by closing a loop of streets to cars so that people can bike, walk, run and skate in the streets without auto traffic. Many cities in the U.S. are establishing similar events as a way to promote health and activity, build community in neighborhoods, increase rates of bicycling and walking, raise awareness of the role of transportation in global warming, and for many other reasons. Communities from El Paso, Texas to Wayne County, Michigan are closing off sections of roadway to create temporary linear park spaces to promote walking and cycling.

Streets should be selected to create a seven- to ten-mile loop that links residential areas with scenic destinations. The County could use



Figure 36. Portland’s Sunday Parkways events draws cyclists of all ages and abilities.

the route developed for the Ride Around Clark County or County staff can explore options to partner with neighborhoods and schools to hold Ciclovias. Examples of successful Ciclovía/Sunday Parkway events include:

- Portland Sunday Parkways: portlandsundayparkways.com/
- New York City's Summer Streets: www.nyc.gov/html/dot/summerstreets/html/home/home.shtml
- Chicago's Open Streets: www.activetrans.org/openstreets
- Seattle Carfree Days: www.seattle.gov/transportation/carfreedays.htm

Develop an East County Scenic Tour

Clark County should identify a continuous loop through the East County area, which would provide a route for longer recreational rides. The County could include parts of the proposed Chelatchie Prairie Trail, as well as on-street portions, to focus bicycle and pedestrian improvements. The tour should be an on-going effort, with the County designating it through signage and pavement markings at key intersections, with the long-term goal of providing a continuous off-street facility to accommodate families and bicyclists less comfortable riding in traffic.

Improve Communications between Community Planning, Engineering, and Operations

In order to facilitate a focus on non-motorized transportation planning and projects, Clark County should convene a group of planners and staff from the Public Works department. The group would identify where streets could be re-striped to accommodate cyclists. Community Planning and Engineering should coordinate with Operations regarding where to re-stripe. The group should also coordinate with staff from the other jurisdictions, Vancouver-Clark Parks Department, C-TRAN, and the Washington Department of Transportation regarding bicycle and pedestrian infrastructure.

The group should meet quarterly to discuss projects related to bicycle and pedestrian planning in the county. The meetings should be open to staff at all jurisdictions in Clark County, and the group should provide support to jurisdictions interested in accommodating bicyclists and pedestrians through planning and construction efforts.

Chapter 8. Implementation Plan

Clark County's recommended pedestrian and bicycle system consists of a comprehensive network of sidewalks, on-street bikeways, shared-use paths, and various programmatic measures. This chapter proposes an implementation strategy that targets the best way to implement projects and programs under different funding scenarios.

Grant funding sources are identified on federal, state and local levels. Finally, the chapter closes with a discussion of supportive policies that can bolster and institutionalize the development of a high-quality walkway and bikeway network.

Implementation Strategies

Chapter 3 of this Plan presents a set of goals, policies, and actions for developing and bicycle and pedestrian network in the County, as well as encouraging walking and bicycling through supportive development and programs. The action items provide an overview of key strategies for encouraging development of bicycle and pedestrian infrastructure on a policy level. The implementation strategies presented below are targeted actions for the County and the Bicycle and Pedestrian Advisory Committee to focus their efforts on. These strategies are the first step toward implementing this Plan.

Strategy 1: Continue Funding Bicycle and Pedestrian Projects with the Capital Budget

As previously noted, the recommended infrastructure projects have been prioritized to identify projects which provide the highest benefits for the least cost. Therefore, Clark County undertake the following action items:

- Pursue implementation of high priority improvements first.
- Incorporate sidewalk and bicycle projects into upcoming public works projects, such as re-striping a street for bike lanes when it is repaved, regardless of the priority the bicycle or pedestrian project.
- Be prepared to work quickly when a fast-moving improvement project is identified (e.g., due to safety concerns, etc.) to integrate bicycle and pedestrian elements where possible.

Strategy 2: Leverage Local Funds to Pursue Grant Opportunities

It is important to recognize that bicycle and pedestrian projects are less likely to be completed if they rely exclusively on County Budget capital. In addition, County staff should undertake the following actions related to grant funding:

- Pursue grant funding and partnerships to provide the infrastructure and programmatic recommendations.
- If promising grant programs or partnership opportunities are identified, or construction of another roadway project makes construction of a lower priority project possible, then the County should pursue that project regardless of priority.
- Work with government agencies (such as Vancouver-Clark Parks Department) to leverage grant funding.

Strategy 3: Establish Public/Private Funding Opportunities and other Partnership Opportunities

Several opportunities exist to partner with schools, CTRAN, and other organizations to develop programs and implement construction projects in conjunction with development. Action items include:

- Ensure that identified pedestrian and bicycle facilities are constructed when development occurs, rather than utilizing County resources.
- Work with partner organizations to identify opportunities for public/private funding.
- Pursue partnerships with utilities for green streets.

Strategy 4: Work with the Bicycle and Pedestrian Committee to Pursue Funding Opportunities

As noted above, relying exclusively on County Road Fund is insufficient to develop the programs and infrastructure recommended in this Plan. The Bicycle and Pedestrian Committee (PBAC) made the following recommendations and statements:

- The PBAC will support any effort the County and cities make to establish a transportation benefit district if a portion of the funds from the district were dedicated to establishing a program for supporting non-motorized forms of transportation.
- Any Transportation Benefit District created should incorporate all municipalities in the County and that those municipalities should receive funding in proportion to their respective population sizes.

- The Committee will not support bicycle licensing fees or bicycle sales tax, nor any funding strategy that discourages bicycling and/or walking.

Strategy 5: Integrate Bicycle and Pedestrian Planning into Clark County’s Planning Process

This plan presents a vision for the future of bicycling and walking in Clark County. To ensure that the vision is implemented, the Plan must become a living document that is incorporated into the day-to-day activities of planning, design, funding, construction, and maintenance in the community.

Action items include:

- Update the Bicycle and Pedestrian Plan as necessary, minimum of every five years.
- Require that all new road projects are reviewed in the planning phase by the Bicycle and Pedestrian Advisory Committee. Require all new road projects to be bicycle and pedestrian friendly.
- Ensure consideration for bicycle and pedestrian travel through construction zones.
- Require development projects to construct sidewalk on all streets, except as per Clark County’s Arterial Atlas..
- Collaborate with other jurisdictions on bicycle and pedestrian projects when possible.
- Support the U.S. Department of Transportation’s efforts to treat Bicycle and Pedestrian projects equally with projects for the automobile. The future Surface Transportation Act may include a proposed Metropolitan Mobility Program that could drastically change the way investments in transportation are made in the next transportation bill.

Strategy 6: Benchmark Bicycle and Pedestrian Growth

In order to evaluate the impact of the County’s Bicycle and Pedestrian Program, the County should track progress in development of the bicycle and pedestrian networks, as well as tracking the state of cycling and walking in the county. Actions include:

- Annually publish the amount of sidewalks and bike lanes constructed by Public Works. The list will be broken down by sidewalk and bike lane constructed as part of a road project, in addition to showing sidewalk and bike lane constructed as stand alone, “retrofitting” projects. This will help meet the benchmarking goal of this plan.



Figure 37. The National Bicycle and Pedestrian Documentation Project provides resources and guidance for counting bicyclists and pedestrians. Bikepeddocumentation.org

- Collect data regarding crashes involving bicyclists and pedestrians. This information will be drafted in an annual report on bicycling and walking in Clark County. Present the annual state of bicycling and walking in Clark County at an annual joint meeting between the Board of County Commissioners and the Bicycle and Pedestrian Advisory Committee.

Current Clark County Bicycle and Pedestrian Program Funding

Most bicycle facilities and sidewalks in the county result are developed in conjunction with capital road projects or private development projects. Most communities that construct bicycle facilities leverage local money as a match for outside funding sources. Capital road projects are funded by gas tax revenues augmented by multiple state and federal grants, including several SAFTEA-LU programs. County code also requires that development projects upgrade street frontage to current standards specified in the county Arterial Atlas.

Infill projects or “spot” improvements in the sidewalk network are filled in via the Sidewalk Infill Program, an ongoing program that is allocated County Road Fund money during annual updates to the county Transportation Improvement Program (TIP). The program was allocated approximately \$200,000 in 2010, and is expected to receive a comparable amount in the future. An average of 19.6 miles of new walkway have been added to the county network each year as a result of these projects, as shown in Table 27. Some sidewalk projects may also be constructed with new park development.

Table 27. Clark County Sidewalk Network

Year	Jan 1 Miles	Miles Added
2009	471	N/A
2008	455	15.57
2007	436	18.34
2006	410	26.40
2005	392	18.25

Data from Mobility road log database via County Road Admin Board (CRAB)

Comparison of Spending on Bicycle and Pedestrian Facilities

Most construction of bicycle and pedestrian facilities is accomplished by including this construction in capital-funded road reconstruction projects. As a result, the relative funding for both types of facilities has been similar in recent years, as major arterials with both sidewalk and dedicated bike lanes are reconstructed to current standards.

Between 8% and 13% of capital road construction dollars has been expended adding bicycle lanes to projects. The range of annual expenditures for sidewalk projects has been 1% to 15% of total construction phase funding, as shown in Table 28.

Table 28. Pedestrian and Bicycle Construction Funding

Year	Bicycle Lane Project			Sidewalk Projects			Total Construction*	Total
	Capital†	Individual‡	Percent	Capital	Individual	Percent		
2010	\$872,250	\$ -	13%	\$872,250	\$994,000	15%	\$6,609,000	28%
2009	\$1,660,800	\$ -	8%	\$1,660,800	\$260,000	1%	\$21,043,000	9%
2008	\$4,965,800	\$ -	12%	\$4,965,800	\$500,00	1%	\$40,096,000	14%
2007		\$ -			\$100,000			

* **Total Construction:** Annual sum of capital and stand alone projects including bike lanes and/or sidewalks.

† **Capital:** Percentage of road cross section dedicated to bike lanes or sidewalks multiplied by total cost of project including design, right-of-way and construction phases

‡ **Individual:** Projects not part of larger capital road construction.

Table 29. Sidewalk Infill Program

Year	Budget
2007	\$150,000
2008	\$350,000
2009	\$200,000
2010	\$450,000
2011	\$650,000

Sidewalk Infill Program

Infill projects or “spot” improvements in the sidewalk network are filled in via an ongoing program that is allocated County Road Fund during annual updates to the county Transportation Improvement Program (TIP).

The Annual Sidewalk Program has been/is currently allocated the funding shown below, and reflects a Board of Clark County emphasis on increased sidewalk funding in 2008. Future funding levels shown are subject to change in future year TIP updates.

Sidewalk proposals for the infill program come from multiple sources including citizen requests. Proposals are evaluated for safety, proximity to destinations and connection to other transportation modes (i.e.: bus routes) among other factors. Projects with the highest scores undergo a detailed

examination including construction estimates to insure that the maximum number of most beneficial projects is constructed each year.

Cost Examples:

Full Bikeway Treatment on 7.7 miles of county is approximately \$6,600.

Table 30. Bikeway Treatments

Travel Direction	Feet	Miles	Treatment	Number	Cost
Northbound	20,221	3.8	Striping		\$574
			Bicycle Lane Symbols	10.1	\$1,365
			Signs	10.1	\$1,365
			Total	20.2	\$3,304
Southbound	20,221	3.8	Striping		\$574
			Bike Lane Symbols	10.1	\$1,365
			Signs	10.1	\$1,365
			Total	20.2	\$3,304
Northbound & Southbound			Striping		\$1,149
			Bike Lane Symbols	20.2	\$2,730
			Signs	20.2	\$2,730
			Total	40.4	\$6,609

Source: Clark County Public Works

Sidewalk construction for one mile of sidewalk is about \$125.00 per foot, or \$660,000 based on the 2008 Pedestrian / Bicycle construction funding (\$500,000) and added sidewalk (15.57 miles) as shown above. This estimate includes developer-paid and other walkways that were added at no cost to the County.

Potential Funding Sources

The project advisory committees reviewed many funding sources that have been used or proposed for bicycle and pedestrian improvements and maintenance. These sources are listed in Appendix F. The Bicycle and Pedestrian Advisory Committee (BPAC) recommended that Clark County consider instituting a dedicated source of funding for bicycle and pedestrian projects. The BPAC will support any efforts the cities and County make to establish a transportation benefit district, if a portion of the funds from this district were dedicated to establishing a program for supporting non-motorized forms of transportation.

The BPAC also agreed that, if this non-motorized fund were established, some of the fund could be used for grant matching money. The committee recommended that any Transportation Benefit District created should

incorporate all municipalities in the County and that those municipalities should receive funding in proportion to their respective population sizes.

In addition, the BPAC will work to establish funding partnerships with private businesses and also to establish a voluntary fund to support bicycle programs.

Funding Implementation – Transportation Benefit District

Several of the potential funding sources would require the development of a Transportation Benefit District (TBD). A TBD is a quasi-municipal corporation and independent taxing district created for the sole purpose of acquiring, constructing, improving, providing, and funding transportation improvements within the district. The legislative authority of a county or city creates a TBD by ordinance following the procedures set forth in RCW Chapter 36.73. The county may form inter-local agreements to include other counties, cities, port districts, or transit districts.

The County would be required to develop a plan that specifies the transportation improvements to be provided or funded by the TBD. As part of this plan, the TBD's governing board can indicate if the funds will be used immediately, or if they will be collected for a specified period. Typically, funds that are collected for a specified period before being expended are used to fully fund large projects, when bonding, or serve as a match for state or federal funds that may only become available in a specified time frame.

A TBD can fund any transportation improvement contained in any existing state or regional transportation plan that is necessitated by existing or reasonably foreseeable congestion levels. This can include maintenance and improvements to city streets, county roads, state highways, investments in high capacity transportation, public transportation, transportation demand management and other transportation projects identified in a regional transportation planning organization plan or state plan. TBD's have several revenue options subject to voter approval:

1. Property taxes – a 1-year excess levy or an excess levy for capital purposes;
2. Up to 0.2% sales and use tax;
3. Up to \$100 annual vehicle fee per vehicle registered in the district;
and
4. Vehicle tolls.

TBD's have two revenue options not subject to voter approval, but subject to additional conditions:

1. Annual vehicle fee up to \$20. This fee is collected at the time of vehicle renewal and cannot be used to fund passenger only ferry-service improvements.
2. Transportation impact fees on commercial and industrial buildings. Residential buildings are excluded.

In addition, the county must provide a credit for a commercial or industrial transportation impact if the county has already imposed a transportation impact fee. The boundaries of a TBD must be countywide, or citywide if the TBD chooses to exercise the tax authority that does not require a public vote (e.g. vehicle and impact fees).

Local Funding Options Considered

The Bicycle and Pedestrian Advisory Committee considered a range of local funding options. Table 31 is a summary of the benefits and drawbacks of these options. Additional information on these opportunities is provided in Appendix F.

- A **Local Option Gas Tax** uses an efficient collection system that already is in place and would divert a very high percentage of revenue collected to projects. The local maximum is \$0.034/gallon and would require a vote.
- **Vehicle Licensing Fees** are collected when owners register their vehicles. Clark County could form a TBD to charge a local fee above the \$43.73 currently charged, \$3 of which goes to the County.
- A **Commercial Parking Tax** may be imposed by a county on unincorporated areas on and may be applied to the gross commercial parking proceeds or number of parking spaces offered to tenants or patrons.
- A **fee-in-lieu** of a tax could be charged for the privilege of parking a motor vehicle in a facility operated by a commercial parking business. The fee would be in the form of a flat charge added to a vendor's parking charge. This option was determined to be infeasible in Clark County as no significant parking facility exists.
- **Street User Maintenance Fees/Transportation Utility Fees** are collected to offset the impact that various land uses such as industrial uses with heavy trucks have on the road system; a proxy measure (e.g. average daily trip measures) is used to determine an impact rate and assess the fee.
- **Utility Taxes** apply to gross revenue generated by the utility in exchange for the privilege of using public rights of way for extending services to customers. The tax may be imposed on all entities that use public rights of way to deliver services to customers, whether they are municipal or private utilities.

- A portion of the existing **Local Sales Tax** could be used to improve pedestrian and bicycle infrastructure.
- A **Bike Tax** would apply to the sale of all new bicycles sold within the county with proceeds dedicated to improving bicycle infrastructure.
- A **Bicycle Licensing Fee** would charge a fee for riding in the county. Registration fees tend to deter bicycling and are difficult to enforce, particularly with cyclists coming from other jurisdictions. In addition, registration fees seldom provide more revenue than they cost.⁵
- **Property Tax Levy/Local Ad Valorem Measures** assess a tax rate on the value of real and personal property. Currently, the largest source of money for roadways in Clark County is from property taxes – the owner of a \$200,000 home pays \$311 per year in road taxes.⁶ Given the relatively small cost of bike and pedestrian system improvements in comparison the County’s overall budget or total transportation budget, and the ability to phase construction of these improvements, a debt-free approach may have more appeal with voters.
- **Local Improvement Districts (LIDs)** are most often used by cities to construct localized projects such as streets, sidewalks or bikeways. Through the LID process, the costs of local improvements are generally spread out among a group of property owners within a specified area. The cost can be allocated based on property frontage or other methods such as traffic trip generation.

⁵ The city manager in Tucson, Arizona found that, for a \$10 bicycle registration fee, the cost of implementation would be higher than the revenue generated.

streetsblog.net/2010/03/24/revisiting-the-idea-of-a-bicycle-tax/

⁶ www.columbian.com/news/2010/jun/16/mielke-urges-higher-vehicle-fees-to-fund-road-proj/

Table 31. Summary of Funding Options

Financing Mechanism	Advantages	Disadvantages	Actions Needed to Implement
Local Fuel Tax	<ul style="list-style-type: none"> Collection system is in place Significant potential revenue Low implementation and overhead costs Can be enacted by County 	<ul style="list-style-type: none"> Significant effort to enact 	<ul style="list-style-type: none"> Adoption by County Coordination with other entities, if desired Amendment of regional plans Possible voter approval
Vehicle License Fee	<ul style="list-style-type: none"> Can be enacted by County Significant potential revenue No voter approval required for lower fee (\$20) 	<ul style="list-style-type: none"> Voter approval required for higher fee (\$100) 	<ul style="list-style-type: none"> Preparation of fee calculations, collection mechanism Adoption by County
Commercial Parking Tax Authority	<ul style="list-style-type: none"> No state or voter approval required Significant potential revenue 	<ul style="list-style-type: none"> Potential equity concerns associated with fee Implementation and monitoring costs could be high 	<ul style="list-style-type: none"> Establish basis for fee or tax, including dedication to bike/ped facilities Adopt by local ordinance
Street User/Maintenance Fee	<ul style="list-style-type: none"> Could collect through existing billing systems 	<ul style="list-style-type: none"> Potential equity issues Revenue potential lower than other tools 	<ul style="list-style-type: none"> Establish basis for fee and dedication requirements Adopt by ordinance
Utility Tax - Electricity, Natural Gas & Telephone	<ul style="list-style-type: none"> Would be an expansion of an existing fee Good revenue potential for modest fee increase 	<ul style="list-style-type: none"> Potentially harder to dedicate proceeds to specific purpose Will require voter approval 	<ul style="list-style-type: none"> Establish basis for fee and dedication requirements Adopt by ordinance
Local Sales Tax (0.2%)	<ul style="list-style-type: none"> Significant revenue potential depending on how much dedicated to bike/ped projects 	<ul style="list-style-type: none"> No voter approval required if applied for less than 10 years Linkage between source and use of tax is tenuous 	<ul style="list-style-type: none"> Gauge public support
Bicycle Sales Tax (\$5)	<ul style="list-style-type: none"> Clear nexus between who pays and who benefits 	<ul style="list-style-type: none"> Collection and enforcement costs vary, often leaving little tax revenue for improvements May result in bike sale shifting to adjacent jurisdictions 	<ul style="list-style-type: none"> Inventory bike sales outlets to better assess the collection/enforcement costs Research existing ordinances Gauge public support
Property Tax Levy	<ul style="list-style-type: none"> Significant revenue potential 	<ul style="list-style-type: none"> Voter approval 	<ul style="list-style-type: none"> Gauge public support
Local Bond Measures	<ul style="list-style-type: none"> Significant revenue potential 	<ul style="list-style-type: none"> Voter approval 	<ul style="list-style-type: none"> Gauge public support
Local Improvement Districts (LID)	<ul style="list-style-type: none"> May permit non-ad valorem basis for assessing the tax 	<ul style="list-style-type: none"> Time consuming and expensive to administer Legality questionable Voter approval 	<ul style="list-style-type: none"> Gauge public support

Table 32. **Potential Local Funding Sources**

Potential Funding Source	New Authority Required	Commission Approval Required	Voter Approval Req'd	State Approval Req'd	Potential Funding Amount	
Vehicle License Fee	Up to \$20	Transportation Benefit District	Yes	No	No	Up to \$3.5 million annually *(1)
	\$20 to \$100	Transportation Benefit District	Yes	Yes	No	Up to \$17.5 million annually *(1)
Commercial Parking Tax Authority	None	Yes	No	No	\$230,000+ annually *(8)	
Street User/Maintenance Fee	None	Yes	No	No	\$380,000 annually *(7)	
Utility Tax -Electricity, Natural Gas & Telephone	None	Yes	Yes *(6)	No	\$3.7+ million annually per 1% tax *(9)	
Local Sales Tax (0.2%)	Transportation Benefit District	Yes	No *(4)	No	Max. of \$8.2 million annually *(5)	
Property Tax Levy	None	Yes	Yes	No	Variable	
Bicycle Sales Tax (\$5)	None	Yes	No	No	\$130,000 annually *(2)	
Local Bond Measures	None	Yes	Yes	No	Variable	
Local Improvement Districts (LID)	Local Improvement District	Yes	No	No	\$4 million one-time assessment *(3)	

Notes:

*(1) Figure from Thayer Rorabrough, as quoted in *The Columbian* on June 16, 2010. Projected revenue and number of vehicles registered in city may decline if vehicle owners begin registering vehicles in neighboring areas to avoid fees.

*(2) Assumes \$5 tax per bicycle sold. Assumes rate of bicycles sold per capita in Clark County is same as national rate.

*(3) Example amount from Broadway Street LID in Tacoma, WA. Total project cost was \$12 million, \$3,915,000 of which was generated by property tax assessment. Actual revenue will vary by project.

*(4) Tax may be imposed for ten years without voter approval. After ten years, voter approval is required to extend the tax by a maximum length of ten years.

*(5) Maximum allowable rate is 0.2%. Rough estimate based on 2009 taxable sales of \$4.1B in Clark County from Washington Department of Revenue; sales tax revenues will vary year to year.

*(6) Use tax may be imposed up to a rate of 6% without voter approval. Voter approval is required for any rate exceeding 6%. Clark County's tax rate is currently at the 6% maximum for all utilities, so any further increase would require voter approval.

*(7) Assessed through water bill. Rough estimate uses proposed Portland, OR 2007 street user fee as example rate (\$4.50/household/year); uses \$250/year as example business rate. Assessed business rate could vary based on estimated street use/impact per business. Estimated revenues are for Clark County Public Utilities customer base ONLY (approximately 30,000 household and businesses). Additional water utilities within incorporated areas of Clark County must be calculated separately.

*(8) Assumes 10% tax on total revenue. Estimate applies to Vancouver Municipal Parking Garages ONLY. Figures for privately-owned lots and other locations in Clark County were unavailable. Estimate assumes minimum annual revenue of \$1,800 per stall.

*(9) Assumes utility customer base of 172,000 households.

This page intentionally left blank.