

# Clark County Stormwater Manual 2015

Book 2  
BMP Design

November 24, 2015

[ERRATA v. strikeout/underline \(September 2016\)](#)



The *Clark County Stormwater Manual: Book 2 – BMP Designs* is adapted from the *Stormwater Management Manual for Western Washington*, (Ecology, 2014) Volumes I, II, III, and V.

Illustrations and drawings are courtesy Washington Department of Ecology or redrawn from Washington Department of Ecology, unless otherwise noted. Illustrations are simplified representations of stormwater facilities; they are not to scale and they require detailed engineering for use in design or construction. Design requirements in text take precedence over figures.

## Table of Contents

<b>Introduction to Book 2</b> .....	<b>1</b>
<b>Chapter 1 Hydrologic Computation and Analysis</b> .....	<b>3</b>
1.1 Introduction .....	5
1.2 Minimum Computational Standards.....	5
1.3 Hydrologic Analysis.....	7
<b>Chapter 2 On-site Stormwater Management BMPs</b> .....	<b>19</b>
<b>Chapter 3 Runoff Treatment Facility Design</b> .....	<b>119</b>
3.1 General Design Criteria .....	121
<b>Chapter 4 Runoff Treatment BMPs</b> .....	<b>143</b>
<b>Chapter 5 Flow Control: Infiltration</b> .....	<b>247</b>
5.1 Infiltration Facility Design .....	249
5.2 Infiltration BMPs.....	253
<b>Chapter 6 Flow Control: Detention</b> .....	<b>261</b>
6.1 Detention Facility Design.....	263
6.2 Detention BMPs .....	273
<b>Chapter 7 Conveyance Design</b> .....	<b>301</b>
7.1 Introduction .....	303
7.2 Design and Construction Standards .....	303
7.3 Design Storm Frequency .....	304
7.4 Conveyance System Testing.....	304
7.5 Hydraulic Methods .....	305
7.6 Drainage of Highway Pavements .....	310
7.7 Drainage System Outfall Requirements .....	311
<b>Chapter 8 Sediment and Erosion Control BMPs</b> .....	<b>313</b>
<b>Book 2 References</b> .....	<b>453</b>

## Appendices

Appendix 2-A	Hydrology
Appendix 2-B	WWHM Information, Assumptions, and Computational Steps
Appendix 2-C	Low Impact Development Modeling Guidance
Appendix 2-D	Approaches to Infiltration Facility Design
Appendix 2-E	Bioretention Soil Mix Hydraulic Conductivity
Appendix 2-F	Turbulence and Short-Circuiting Factor
Appendix 2-G	Geotextile Specifications

# Introduction to Book 2

Book 2 of the Clark County Stormwater Manual provides design details and criteria for Best Management Practices (BMPs) to be used to meet applicable Minimum Requirements. This book is primarily technical. Use this book in conjunction with Book 1, which has information on the applicability and selection of BMPs.

BMP numbers used in this manual have been modified from those used in the *Stormwater Management Manual for Western Washington* (Ecology, 2014); however, the two often coincide.

Note that the list of available BMPs is constantly changing, as BMPs classified as emerging technologies are implemented in practice. More information on emerging technologies is available in Chapter 3 of Book 1.

Clark County maintains a Standard Details Manual for transportation, erosion control, drainage, and planting details. Other agencies also publish standard details that may be accepted by the Responsible Official. A designer using a standard detail should follow the associated language within the pertinent agency manual. Design requirements in this manual's text take precedence over standard details.

Links to standard details include:

- [Clark County Public Works Standard Details Manual](#)
- Washington State Department of Transportation – [Standard Plans 2015](#), or as revised, and [Standard Specifications for Road, Bridge, and Municipal Construction, 2014, M 41-10](#)
- [Washington State Department of Transportation Hydraulics Manual](#) – for culvert design

This page purposefully left blank.

# Chapter I Hydrologic Computation and Analysis

## Chapter Contents

<b>1.1</b>	<b>Introduction.....</b>	<b>5</b>
1.1.1	Purpose.....	5
1.1.2	How to Use this Chapter.....	5
<b>1.2</b>	<b>Minimum Computational Standards.....</b>	<b>5</b>
<b>1.3</b>	<b>Hydrologic Analysis .....</b>	<b>7</b>
1.3.1	Flow Duration Standards.....	7
1.3.1.1	Low Impact Development Performance Standard.....	8
1.3.1.2	Flow Control Standard.....	8
1.3.2	Continuous Flow Modeling.....	9
1.3.2.1	Data Requirements .....	9
1.3.3	Single Event Hydrograph (Santa Barbara Urban Hydrograph (SBUH)).....	12
1.3.4	Rational Method.....	15
1.3.5	Modeling Discharges to Wetlands.....	16
1.3.6	Closed Depression Analysis .....	16
1.3.6.1	Analysis and Design Criteria .....	17

## Chapter Tables

Table 1.1:	Summary of the applicable design methodologies .....	7
------------	--	---

This page intentionally left blank.



## 1.1 Introduction

### 1.1.1 Purpose

This chapter presents the basic methods and criteria for analysis and design of all types of stormwater facilities, including on-site stormwater management, infiltration, flow control, treatment and conveyance.

These methods and criteria will give the engineering basis for selecting BMPs to meet Minimum Requirements #5, # 6, #7 and #8, as well as county requirements for conveyance.

This chapter defines the minimum computational standards required, how these may be applied, and references where more complete details may be found, should they be needed. This chapter also provides details on the hydrologic design process; that is, what are the steps required to conduct a hydrologic analysis, including flow routing.

### 1.1.2 How to Use this Chapter

This chapter describes the minimum computational standards required and outlines how these standards are to be applied. This chapter also provides details on the hydrologic design process; that is, what are the steps required in conducting a hydrologic analysis, including flow routing.

This chapter includes the following sections:

- [Section 1.2](#) provides minimum computational standards for designing stormwater facilities.
- [Section 1.3](#) discusses hydrologic methods to be used for calculating runoff quantities and rates.

## 1.2 Minimum Computational Standards

The minimum computational standards depend on the type of information required and the size of the drainage area to be analyzed, as follows:

1. For the purpose of designing most types of runoff treatment BMPs, an approved continuous flow model must be used to calculate runoff and determine the water quality design flow rates and volumes. See [Section 1.3](#) for approved models. See [Section 3.1.1](#) for water quality design flow rates and volumes.
2. For the purpose of designing wetpool treatment facilities, there are two acceptable methods:
  - a. An approved continuous flow model to estimate the 91st percentile, 24-hour runoff volume.

- b. The NRCS (Natural Resources Conservation Service) curve number method to determine a water quality design storm volume. The water quality design storm volume is the amount of runoff predicted from the 6-month, 24-hour storm (defined as 70 percent of the 2-year, 24-hour storm).
3. Flow-related standards are used to determine whether or not the proposed stormwater facility or facilities will provide a sufficient level of control for the additional runoff from land development (See [section 1.5.7 in Book 1](#) for flow control requirements). There are three flow-related standards used to meet the requirements of this manual:
- c. Minimum Requirement #5 – On-site Stormwater Management: Minimum Requirement #5 allows the user to demonstrate compliance with the LID Performance Standard of matching developed discharge durations to pre-developed durations for the range of pre-developed discharge rates from 8% of the 2-year peak flow to 50% of the 2-year peak flow. If the post-development flow duration values exceed any of the pre-development flow levels between 8% and 50% of the 2-year pre-development peak flow values, then the LID Performance Standard has not been met. An approved continuous flow model must be used for this analysis.
  - d. Minimum Requirement #7 – Flow Control: For projects triggering Minimum Requirement #7, if the model predicts a 0.10 cfs or greater increase in the 100-year return frequency flow (or a 0.15 cfs increase for 15-minute time steps), or if certain thresholds of impervious surfaces or converted pervious surfaces are exceeded within a threshold discharge area (see [Book 1, Section 1.4](#), Minimum Requirement #7), then the project must comply with the flow control standard. An approved continuous flow model must be used for this analysis.
- Minimum Requirement #7 specifies that stormwater discharges to streams shall match developed discharge durations to pre-developed durations for the range of pre-developed discharge rates from 50% of the 2-year peak flow up to the full 50-year peak flow. An approved continuous flow model must be used for this analysis.
- e. Minimum Requirement #8 – Wetlands Protection: Minimum Requirement #8 specifies that total discharge to a wetland must not deviate by more than 20% on a single event basis, and must not deviate by more than 15% on a monthly basis. Flow components feeding the wetland under both pre- and post-development scenarios are assumed to be the sum of the surface, interflow, and groundwater flows from the project site. An approved continuous flow model must be used for this analysis.
4. For the purposes of designing open or closed channel conveyance systems and collection systems (catch basins and inlets), one of the following methods shall be used to determine the peak flow rate for the design storm:

- Santa Barbara Urban Hydrograph (SBUH) method. This method shall be used only for basins of less than 1,000 acres.
  - Rational Method. This method can be used for basins of less than 25 acres, with a time of concentration of less than 100 minutes.
5. Infiltration facilities designed for flow control shall be designed to effectively infiltrate the 100-year, 24-hour design storm event. An overflow route must be identified in the event that capacity is exceeded. Any runoff in excess of infiltration capacity shall also comply with Minimum Requirement #7 if applicable. If the overflow route is a piped connection from a UIC well to surface water, then the UIC shall be modeled with an approved continuous flow model and meet the applicable flow control requirements.

The circumstances under which different methodologies apply are summarized below in [Table 1.1](#).

**Table 1.1: Summary of the applicable design methodologies**

Method	BMP Design		
	Runoff Treatment	Flow Control	Conveyance
Rational Method	Not Applicable	Not Applicable	Method applies
SCSUH/SBUH	Method applies for wetpool-facilities.	Infiltration facility sizing only	Method applies
Continuous flow model	Method applies to all BMPs, except volume based treatment BMPs (wetponds).	Method applies	Not Applicable

## 1.3 Hydrologic Analysis

This section provides a discussion of the hydrologic methods to be used for calculating stormwater runoff quantity and discharge rate from a project site. It includes a discussion of estimating stormwater runoff with an approved continuous flow model, single event models (the Santa Barbara Unit Hydrograph (SBUH) method), and peak runoff calculations methods (the Rational Method).

### 1.3.1 Flow Duration Standards

This section describes two flow duration standards that are required for projects meeting certain thresholds. The Low Impact Development Performance Standard (LID Performance Standard) is required for projects meeting thresholds in Minimum Requirement #5, described in [Book 1, Section 1.5.5](#). The Flow Control Standard is required for projects meeting thresholds in Minimum

Requirement #7, [Section 1.5.7 of Book 1](#). Some projects are required to meet both standards. Consult [Book 1, Section 1.4](#) to determine which standard, if any, a project is required to meet.

Use an approved continuous flow model to determine whether or not the proposed stormwater facility or facilities will meet the applicable standard. The models compute the pre-development 2- through 100-year flow frequency values and compute the post-development runoff 2- through 100-year flow frequency values from the outlet of the proposed stormwater facility. The models use pond discharge data to compare the pre-development and post-development durations to allow the user to determine if the applicable flow duration standard has been met.

### **1.3.1.1 Low Impact Development Performance Standard**

As defined in Minimum Requirement #5, [Section 1.5.25.2 of Book 1](#), the LID Performance Standard is:

Stormwater discharges shall match developed discharge durations to pre-developed durations for the range of pre-developed discharge rates from 8% of the 2-year peak flow to 50% of the 2-year peak flow.

The flow duration values are compared to the following criterion for the LID Performance Standard:

If the post-development flow duration values exceed any of the pre-development flow levels between 8% and 50% of the 2-year pre-development peak flow values then the LID Performance Standard has not been met.

### **1.3.1.2 Flow Control Standard**

As defined in Minimum Requirement #7, [Section 1.5.7.3 of Book 1](#), the standard flow control requirement is:

Stormwater discharges shall match developed discharge durations to pre-developed durations for the range of pre-developed discharge rates from 50% of the 2-year peak flow up to the full 50-year peak flow.

There are three criteria by which flow duration values are compared for the Flow Control Standard:

1. If the post-development flow duration values exceed any of the pre-development flow levels between 50% and 100% of the 2-year pre-development peak flow values (100 Percent Threshold) then the Flow Control Standard has not been met.
2. If the post-development flow duration values exceed any of the pre-development flow levels between 100% of the 2-year and 100% of the 50-year pre-development peak flow values more than 10 percent of the time (110 Percent Threshold) then the Flow Control Standard has not been met.

3. If more than 50% of the flow duration levels exceed the 100% threshold then the Flow Control Standard has not been met.

Note that a pass/fail report is provided by the model for determining whether or not these standards have been met.

### 1.3.2 Continuous Flow Modeling

An approved continuous flow model that models rainfall/runoff relationships over long time periods is required for sizing most BMPs to meet the Minimum Requirements. Models approved for use in Clark County include Ecology's version of the Western Washington Hydrology Model (WWHM), and the Washington State Department of Transportation (WSDOT) hydrologic model MGSFlood. Both models use the software program HSPF (Hydrologic Simulation Program – Fortran) as its base to model hydrologic processes.

Each model uses rainfall and evaporation data and 18 model parameters to simulate runoff from three components: groundwater, interflow, and surface runoff. The model user can specify where these three types of runoff should be directed. Normally, surface runoff and interflow are directed to the stormwater facility.

Clark County has developed a county-specific WWHM model. Precipitation data for the Clark County version of WWHM have been obtained from the Portland Airport and are scaled to address spatial variations in precipitation throughout Clark County. The scaling factors were developed by comparing rainfall data from Clark County stations to the long-range data available from the Portland airport. Evaporation data used in the Clark County version of WWHM are from a pan evaporation station located in Aurora, Oregon.

*At the time of publication, the Clark County version of the WWHM is under review by Ecology. It will be allowed for use in Clark County upon approval by Ecology.*

*Additional information on WWHM can be found in Volume III of the SMMWW or in the WWHM help files and users' manual. Additional information on the Clark County version of WWHM can be found in Otak, 2009. Additional information on MGSFlood can be found in the latest edition of WSDOT's Highway Runoff Manual.*

#### 1.3.2.1 Data Requirements

The following information is required for input into the approved continuous flow model:

- Precipitation

- Soil types and their associated group
- Type of land cover, and the acreage of each

### **Precipitation Data**

- WWHM uses long-term precipitation data to simulate the potential impacts of land use development in western Washington. A minimum period of 20 years is required to simulate enough peak flow events to produce accurate flow frequency results.
- The Clark County version of the WWHM uses hourly precipitation data from the weather station at the Portland International Airport (PDX) as the default precipitation time series data for Clark County. The time series is from October 1949 to September 2008.
- The precipitation stations represent rainfall at elevations below 1500 feet. WWHM does not include snowfall and snowmelt.

### Precipitation Multiplication Factors

Precipitation scaling factors are applied to PDX precipitation data to appropriately scale the data based on geographic location within the county. The Clark County version of the WWHM model incorporates these revised scaling factors into the software program and will automatically select the appropriate factor based upon the proposed project location as input by the user.

### Pan Evaporation Data

The Clark County version of the WWHM uses long-term pan evaporation data from a weather station in Aurora, Oregon. The period of record from the Aurora station used within the Clark County version of the WWHM spans from October 1948 to September 2008.

### **Soil Data**

For the locally calibrated WWHM, National Resource Conservation Service (NRCS) soil types in Clark County are grouped into five categories based on drainage characteristics and experience with Clark County soils. These categories include:

- Soil Group 1 – Excessively drained soils.
- Soil Group 2 – Well drained soils.
- Soil Group 3 – Moderately well drained soils.
- Soil Group 4 – Poorly drained soils.
- Soil Group 5 – Wetland drained soils or mucks.

See [Appendix 2-A](#) for the designation of each NRCS soil type found within Clark County to one of the five soil categories.

This approach to soil classification has been incorporated into the user interface of the Clark County version of the WWHM. The user determines actual local soil conditions for the specific development planned and inputs that data into WWHM. The user inputs the number of acres of each soil category for the site conditions.

### Pre-developed Land Cover Data

The WWHM provides for three different pervious land covers: forest, pasture, and lawn. The pre-developed condition for modeling flow control facilities shall be a forested land cover unless reasonable, historic information is available that indicates the project site was prairie prior to settlement; or

Where an approved basin plan exists, the land cover condition to be matched shall be as commensurate with achieving a target flow regime identified in the study. If no land cover condition or target flow regime is identified, land cover condition to be matched shall be as required above.

Areas within Clark County that were historically prairie are identified in [Appendix 1-D](#). These include Bear Prairie, Fourth Plain, Mill Plain, and Lacamas Prairie. The map in [Appendix 1-D](#) can be used only as an indicator of historic prairie, not for specific prairie boundaries. A project site report prepared by a wetland scientist or horticulturist experienced in identifying soil, plant, and other evidence associated with historic prairies shall be submitted with the Preliminary Stormwater Plan to demonstrate the existence of historic prairie on the project site.

This requirement does not apply to project sites that will retain all stormwater runoff on site.

### Development Land Cover Data

Development land use data are used to represent the type of development planned for the site and are used to determine the appropriate size of the required stormwater facility.

Earlier versions of WWHM included a Standard residential development option which made specific assumptions about the amount of impervious area per lot and its division between driveways and rooftops. Streets and sidewalk areas were input separately. Ecology had selected a standard impervious area of 4200 square feet per residential lot, with 1000 square feet of that as driveway, walkways, and patio area, and the remainder as rooftop area.

The more recent versions of WWHM (e.g., WWHM3 and above) no longer have the Standard residential development category. Users can use the above land use assumptions for modeling runoff from a standard residential development or, where better land use information is available, use that information to model and estimate runoff from the residential development.

WWHM distinguishes between effective impervious area and non-effective impervious area in calculating total impervious area.

Credits are given for infiltration and dispersion of roof runoff and for use of porous pavement for driveway areas. WWHM includes LID modeling features that will calculate credits directly in the model. See the WWHM User Manual or [Appendix 2-C](#) for modeling instructions for LIDs.

Forest and pasture vegetation areas are only appropriate for separate undeveloped parcels dedicated as open space, wetland buffer, or park within the total area of the development, except when use of an on-site stormwater management BMP allows a surface to be modeled as forest or pasture. Development areas must only be designated as forest or pasture where legal restrictions can be documented that protect these areas from future disturbances.

#### Pervious and Impervious Land Categories (PERLND and IMPLND parameter values)

- In HSPF (including WWHM and MGSFlood) pervious land categories are represented by PERLNDs; impervious land categories by IMPLNDs.
- HSPF provides over 20 unique PERLND parameters that describe various hydrologic factors that influence runoff and 4 parameters to represent IMPLND.

Surface runoff and interflow are computed based on the PERLND and IMPLND parameter values. Groundwater flow can also be computed and added to the total runoff from a development if there is a reason to believe that groundwater would be surfacing (such as where there is a cut in a slope). However, the default condition in WWHM assumes that no groundwater flow from small catchments reaches the surface to become runoff.

### **1.3.3 Single Event Hydrograph (Santa Barbara Urban Hydrograph (SBUH))**

Calculation of the peak flow rate or volume using SBUH is usually performed with a spreadsheet or a commercial software program. The following information is required for a SBUH analysis:

- Time of concentration
- Precipitation: 24-hour average daily precipitation for the design storm and for a 2-year event (used in the time of concentration calculations)
- Runoff curve number
- Impervious and pervious areas

The sections below provide information about estimation of the time of concentration, 2-year precipitation depth, and runoff curve numbers.

- Time of Concentration

Time of concentration ( $T_c$ ) is the sum of the travel times for sheet flow, shallow concentrated flow, and channel flow. Travel time ( $T_t$ ) is the time it takes water to travel from one location to another in a watershed.  $T_t$  is a component of the time of concentration. The minimum time of concentration is 5 minutes.



## Sheet Flow

With sheet flow, the friction value ( $n_s$ ) is used (a modified Manning's effective roughness coefficient that includes the effect of raindrop impact; drag over the plane surface; obstacles such as litter, crop ridges, and rocks; and erosion and transportation of sediment). These  $n_s$  values are for very shallow flow depths of about 0.1 foot and are used only for travel lengths up to 300 feet. [Appendix 2-A](#) gives Manning's  $n_s$  values for sheet flow for various surface conditions.

For sheet flow of up to 300 feet, use Manning's kinematic solution to directly compute  $T_t$ :

$$T_t = \frac{0.42(n_s L)^{0.80}}{P_2^{0.527} (S_o)^{0.4}} \quad \text{Equation 1-1}$$

where:

- $T_t$  = travel time (minutes)
- $n_s$  = sheet flow Manning's effective roughness coefficient ([Appendix 2-A](#))
- $L$  = flow length (feet)
- $P_2$  = 2-year, 24-hour rainfall (inches)
- $S_o$  = slope of hydraulic grade line (land slope, feet/feet)

The maximum allowable distance for sheet flow shall be 300 feet; the remaining overland flow distance shall be shallow concentrated flow until the water reaches a channel.

## Shallow Concentrated Flow

After a maximum of 300 feet, sheet flow is assumed to become shallow concentrated flow. The average velocity for this flow can be calculated using the  $k_s$  values from [Appendix 2-A](#), in which average velocity is a function of watercourse slope and type of channel. The average velocity of flow, once it has measurable depth, shall be computed using the following equation:

$$V = k \sqrt{S_o} \quad \text{Equation 1-2}$$

where:

- $V$  = velocity (feet/seconds)
- $k$  = time of concentration velocity factor (feet/seconds)
- $S_o$  = slope of flow path (feet/feet)

“ $k$ ” is computed for various land covers and channel characteristics, with assumptions made for hydraulic radius using the following rearrangement of Manning's equation:

where:

$$k = \frac{1.49R^{0.667}}{n} \quad \text{Equation 1-3}$$

- R = an assumed hydraulic radius
- n = Manning's roughness coefficient for open channel flow ([Appendix 2-A](#))

“k” values have been tabulated in [Appendix 2-A](#). After computing the velocity,  $T_t$  can be computed as follows:

$$T_t = \frac{L}{60V} \quad \text{Equation 1-4}$$

where:

- L = flow length (feet)
- V = average velocity (feet/second)
- 60 = conversion factor from seconds to minutes

## Channel Flow

Open channels are assumed to begin where surveyed cross-section information has been obtained, where channels are visible on aerial photographs, or where lines indicating streams appear on maps and are field verified. The  $k_c$  values from [Appendix 2-A](#) can be used to estimate average flow velocity. After average velocity is computed, the travel time for the channel segment can be calculated using Equation 1-4.

## Time of Concentration Calculation

The time of concentration is the sum of the  $T_t$  values for the various consecutive flow segments.

$$T_t = T_{t1} + T_{t2} + \dots + T_{tm} \quad \text{Equation 1-5}$$

## Precipitation

The standard design hyetograph is the Soil Conservation Service (SCS) Type 1A 24-hour rainfall distribution resolved into 10-minute time intervals, which can be found in [Appendix 2-A](#). Various interpretations of the hyetograph are available and may differ slightly from distributions used in other unit hydrograph-based computer simulations. Other distributions will be accepted with adequate justification and as long as they do not decrease the peak flow rate.

The hyetographs provide a dimensionless distribution of rainfall over a 24-hour period. These values are multiplied by the 24-hour rainfall depth for use in the SBUH method. [Appendix 2-A](#) provides the 24-hour design storm isopluvials for Clark County for determining rainfall depth for different storm frequencies. These have been taken from [The National Oceanic and Atmospheric](#)

[Administration \(NOAA\) Atlas 2 Precipitation – Frequency Atlas of the Western United States, Volume IX, Washington \(Miller et al. 1973\)](#). This 24-hour rainfall depth is used in SBUH calculations.

### Runoff Curve Numbers

The curve numbers in [Appendix 2-A](#) shall be used. The NRCS soil classifications for use in determining the appropriate runoff curve numbers can be obtained from one of the following three sources:

- Updated version of the Soil Survey of Clark County, Washington, originally published in 1972 and updated by the NRCS.
- GIS maps of soils from Clark County GIS.
- Washington Soil Survey Data as available on the NRCS website.

Hydrologic soils groups for NRCS soil classifications for typical Clark County soils are listed in [Appendix 2-A](#).

### Impervious and Pervious Areas

Calculate the amounts of impervious and pervious areas in the proposed development.

## 1.3.4 Rational Method

The Rational Method is a simple method for calculating the peak flow rate that can easily be performed by hand. The formula for the rational method is:

$$Q = CIA \qquad \text{Equation 1-6}$$

where:

- $Q$  = flow (ft<sup>3</sup>/second)
- $C$  = dimensionless runoff coefficient
- $I$  = rainfall intensity (inches/hour)
- $A$  = drainage area (acres)

The following information is required for the Rational Method:

1. Runoff coefficient, which can be found in [Appendix 2-A](#).
2. Time of concentration. This is described above and is used for determining rainfall intensity.

3. Rainfall intensity. These values can be found in [Appendix 2-A](#).
4. Drainage area, which is calculated using topographic site maps.

### 1.3.5 Modeling Discharges to Wetlands

The goal with wetlands is to not alter the natural hydroperiod. This requires the control of input flows such that the wetland is within certain elevations at different times of the year and short-term elevation changes are within the desired limits. If the amount of surface water runoff draining to a wetland is increased because of land conversion from forested to impervious areas, it may be necessary to bypass some water around the wetland in the wet season. (Bypassed stormwater must still meet flow control and treatment requirements applicable to the receiving water.) If however, the wetland was fed by local groundwater elevations during the dry season, the impervious surface additions and the bypassing practice may cause variations from the dry season elevations.

The regulatory strategy for wetlands is to simply try to match the pre-project surface and groundwater inputs that drive the water surface elevations in wetlands. Estimates of what should be done to match inputs require the use of a continuous flow model.

Projects shall comply with Minimum Requirement #8 and Guide Sheets #1 and #2 in [Appendix 1-H](#). The hydrologic analysis shall use the existing land cover condition to determine the existing hydrologic conditions unless directed otherwise by a regulatory agency with jurisdiction.

[Appendix 1-H](#), *Guidelines for Wetlands when Managing Stormwater* shall be used for discharges to natural wetlands and wetlands constructed as mitigation. While it is always necessary to pre-treat stormwater prior to discharge to a wetland, there are limited circumstances where wetlands may be used for additional treatment and detention of stormwater. These situations are considered in Guide Sheet #2 of [Appendix 1-H](#).

Note that if selective runoff bypass is an alternative being considered to maintain the hydroperiod, the hydrologic analysis must consider the impacts of the bypassed flow. For instance, if the bypassed flow is eventually directed to a stream, the flow duration standard, Minimum Requirement #7, applies to the bypassed flow.

### 1.3.6 Closed Depression Analysis

Perform a closed depression analysis for a site that contains a closed depression as defined in [Appendix 1-A](#).

This analysis applies to discharges to any low-lying areas which have no outlet, or such a limited surface outlet that in most storm events the area acts as a retention basin holding water for infiltration or evaporation (hereafter referred to as closed depression). Where the entire project site is located within a closed depression, Clark County may waive the requirement for a route for the

100-year overflow, provided the facility is sized to fully infiltrate the 100-year event and the facility does not have berms on any side.

Closed depressions generally facilitate infiltration of runoff. If there is an outflow to surface water (such as a creek), then the flow from this depression must also meet Minimum Requirement #7 for flow control. If a closed depression is classified as a wetland, then Minimum Requirement #8 for wetlands applies.

The analysis of closed depressions requires careful assessment of the existing hydrologic performance in order to evaluate the impacts a proposed project will have. An approved continuous flow model must be used for closed depression analysis and design of stormwater facilities. If a closed depression is not classified as a wetland, model the ponding area at the bottom of the closed depression as an infiltration pond using an approved continuous flow model.

### **1.3.6.1 Analysis and Design Criteria**

The infiltration rates used in the analysis of closed depressions shall be determined according to the procedures in [Book 1, Section 4.3.1.3](#). For closed depressions containing standing water, soil texture tests must be performed on dry land adjacent to, and on opposite sides of the depression (as is feasible). A minimum of two tests must be performed to estimate an average surface infiltration rate. Wet-season water level fluctuations, measured using a datalogger, are also useful in estimating infiltration rates, especially if the depression currently receives runoff.

Projects proposing to modify or compensate for replacement storage in a closed depression must meet the design criteria for detention ponds as described in this section.

#### **Method of Analysis**

Closed depressions are analyzed using an approved continuous flow model. In assessing the impacts of a proposed project on the performance of a closed depression there are three cases that dictate different approaches to meeting Minimum Requirement #7. Note that where there is a flooding potential, concern about rising groundwater levels, property rights/ownership/use issues, or where the county's critical areas regulations may be violated, this analysis may not be sufficient and the county may require more stringent analysis and impose more stringent requirements.

#### **Case 1 – No Pre-Development Overflow from Closed Depression**

Using an approved continuous flow model, the 100-year storm flow from the TDA is routed into the closed depression, using only infiltration as outflow. Under this scenario, there is no overflow from the closed depression. Determine the pre-development (existing conditions) high water level. The post-development high water level, assuming full build-out of the contributing watershed, shall be no more than 0.1 feet higher than the pre-development level, unless the development has acquired ownership or discharge rights to the closed depression. Absent ownership or discharge

rights, excavate additional storage volume in the closed depression (subject to all applicable requirements, for example, access rights and providing a defined overflow system) or in an upland area, as needed to achieve the development's contribution to the 0.1-foot maximum water level increase standard.

#### Case 2 – Pre-Development Overflow from Closed Depression

Using an approved continuous flow model, the 100-year storm flow from the TDA is routed into the closed depression, using only infiltration as outflow. Under this scenario, pre-development runoff causes overflows from closed depression. For this scenario, the performance objective can be met by excavating additional storage volume in the closed depression such that no overflows occur, subject to all applicable requirements. Alternatively, an appropriately designed flow control and overflow structure can be provided, meeting the standards of Minimum Requirement #7.

#### Case 3 – Pre and Post-Development Overflow from Closed Depression

The 100-year recurrence interval storm runoff from an approved continuous hydrologic model from the TDA to the closed depression is routed into the closed depression using only infiltration as outflow, and both pre-developed and developed conditions cause overflow to occur. The closed depression must then be analyzed as a detention/infiltration pond. The required performance, therefore, is to meet the runoff duration standard specified in Minimum Requirement #7 ([Book 1, Section 1.5.7](#)), using an approved continuous flow model. This will require a control structure, emergency overflow spillway, access road, and other design criteria. Also, depending on who will maintain the system, it will require placing the closed depression in a tract dedicated to the responsible party.

# Chapter 2 On-site Stormwater Management BMPs

## Chapter Contents

<b>BMP T5.10A: Downspout Full Infiltration - Drywells</b> .....	<b>21</b>
<b>BMP T5.10B: Downspout Full Infiltration – Infiltration Trenches</b> .....	<b>23</b>
<b>BMP T5.10C: Downspout Dispersion</b> .....	<b>27</b>
<b>BMP T5.10D: Perforated Stub-out Connections</b> .....	<b>32</b>
<b>BMP T5.11: Concentrated Flow Dispersion</b> .....	<b>35</b>
<b>BMP T5.12: Sheet Flow Dispersion</b> .....	<b>38</b>
<b>BMP T5.13: Post-Construction Soil Quality and Depth</b> .....	<b>41</b>
<b>BMP T5.14A: Rain Gardens</b> .....	<b>45</b>
<b>BMP T5.14B: Bioretention Systems</b> .....	<b>56</b>
<b>BMP T5.15: Permeable Pavements</b> .....	<b>76</b>
<b>BMP T5.16: Tree Retention and Tree Planting</b> .....	<b>84</b>
<b>BMP T5.17: Vegetated Roofs</b> .....	<b>89</b>
<b>BMP T5.18: Reverse Slope Sidewalks</b> .....	<b>92</b>
<b>BMP T5.19: Minimal Excavation Foundations</b> .....	<b>94</b>
<b>BMP T5.20: Rainwater Harvesting</b> .....	<b>97</b>
<b>BMP T5.30A: Full Dispersion</b> .....	<b>100</b>
<b>BMP T5.30B: Dispersion to Pasture or Cropland</b> .....	<b>109</b>
<b>BMP T5.40: Preserving Native Vegetation</b> .....	<b>112</b>
<b>BMP T5.41: Better Site Design</b> .....	<b>115</b>

## Chapter Figures

Figure 2.1: Typical Downspout Infiltration Drywell.....	23
Figure 2.2: Typical Downspout Infiltration Trench .....	26
Figure 2.3: Typical Downspout Dispersion Trench Site Plan.....	28
Figure 2.4: Downspout Dispersion Trench Cross-Section .....	29
Figure 2.5: Dispersion Trench with Notched Grade Board.....	30
Figure 2.6: Typical Splashblock .....	31
Figure 2.7: Typical Perforated Stub-out Connection.....	32
Figure 2.8: Concentrated Flow Dispersion Using Rock Pad.....	35

Figure 2.9: Concentrated Flow Dispersion Using Dispersion Trench.....	36
Figure 2.10: Sheet Flow Dispersion for Flat and Moderate Sloped Surfaces .....	38
Figure 2.11: Typical Planting Bed Cross-section.....	42
Figure 2.12: Typical Rain Garden Profile.....	45
Figure 2.13: Mean Annual Precipitation in Clark County.....	49
Figure 2.14: Bioretention System Typical Cross-Section .....	57
Figure 2.15: Typical Bioretention with Underdrain .....	58
Figure 2.16: Typical Bioretention with Underdrain and Liner – cannot meet MR #5.....	58
Figure 2.17: Typical Bioretention Planter.....	59
Figure 2.18: Example Pedestrian Rail System.....	63
Figure 2.19: Permeable Pavement Application.....	78
Figure 2.20: Permeable Pavement Typical Section .....	79
Figure 2.21: Permeable Pavement Typical Section of Pavers.....	79
Figure 2.22: Permeable Pavement Check Dam for Sloped Pavement.....	80
Figure 2.23: Trees preserved and planted in a development .....	84
Figure 2.24: Illustration of Tree Retention and Tree Planting Concepts .....	87
Figure 2.25: Example Vegetated Roof in Philadelphia.....	89
Figure 2.26: Vegetated Roof Typical Section.....	91
Figure 2.27: Reverse Slope Sidewalk Schematic.....	92
Figure 2.28: Pin Pier Foundation Construction & Completed Project, Bainbridge Island.....	94
Figure 2.29: Cistern for Rainwater Harvesting .....	97
Figure 2.30: Cropland in Clark County Suitable for Full Dispersion to Pasture or Cropland .....	109
Figure 2.31: Trees Preserved on a Development Site.....	112
Figure 2.32: Example from Cold Creek Crossing of LID Integration with Site Design.....	115

## Chapter Tables

Table 2.1: Rain Garden Sizing Factors .....	48
Table 2.2: Plant List for Rain Garden* .....	52
Table 2.3: Plant List for Bioretention* .....	70
Table 2.4: Typical Applications for Types of Permeable Pavements.....	78
Table 2.5: PCIP Seed Mix.....	82
Table 2.6: Tree Credits – Retained Trees .....	88
Table 2.7: Tree Credits – Newly Planted Trees.....	88



## BMP T5.10A: Downspout Full Infiltration - Drywells

---

### Purpose and Description

Downspout Full Infiltration Drywells are designed to infiltrate runoff from roof downspout drains and cannot be used to directly infiltrate runoff from pollutant-generating surfaces. These facilities can be pre-manufactured structures, or they can be simply holes in the ground filled with rock, as shown in [Figure 2.1](#). Alternatives to rock-filled drywells, such as preformed chambers, are acceptable if equivalent storage volume is provided.

### Cross Reference Guide

Soils Assessment	<a href="#">Book 1, Section 2.3</a>
Meets Minimum Requirements	#5
Related BMPs	None
T5.10a Selection Criteria	<a href="#">Book 1, Sections 2.2 and 2.5.1</a>
Maintenance	<a href="#">Book 4</a>

### Applications, Limitations and Setbacks

Geotechnical analysis is an important first step to determining the feasibility of using downspout full infiltration. The required site analysis includes an initial assessment of the type of site soils, and the infiltration potential. See [Section 2.3 in Book 1](#) for guidance regarding required site soils analysis.

Roof downspout drywells are deemed feasible without infiltration testing when a qualified professional determines that USDA textural classes consisting of coarse sand to medium sand, loam, or cobbles and gravels are present in the infiltration zone. If other soils are present in the infiltration zone consider a rain garden or bioretention facility instead.

Items that make roof downspout drywells infeasible include:

- Less than three feet of permeable soil exists from the proposed finished ground elevation above the drywell to the seasonal high groundwater table.
- Less than one foot of clearance exists between the proposed bottom of the drywell and the seasonal high groundwater table.
- The downspout full infiltration system cannot meet the setbacks specified below.
- The downspout full infiltration system cannot meet the design criteria specified below.

## Setbacks

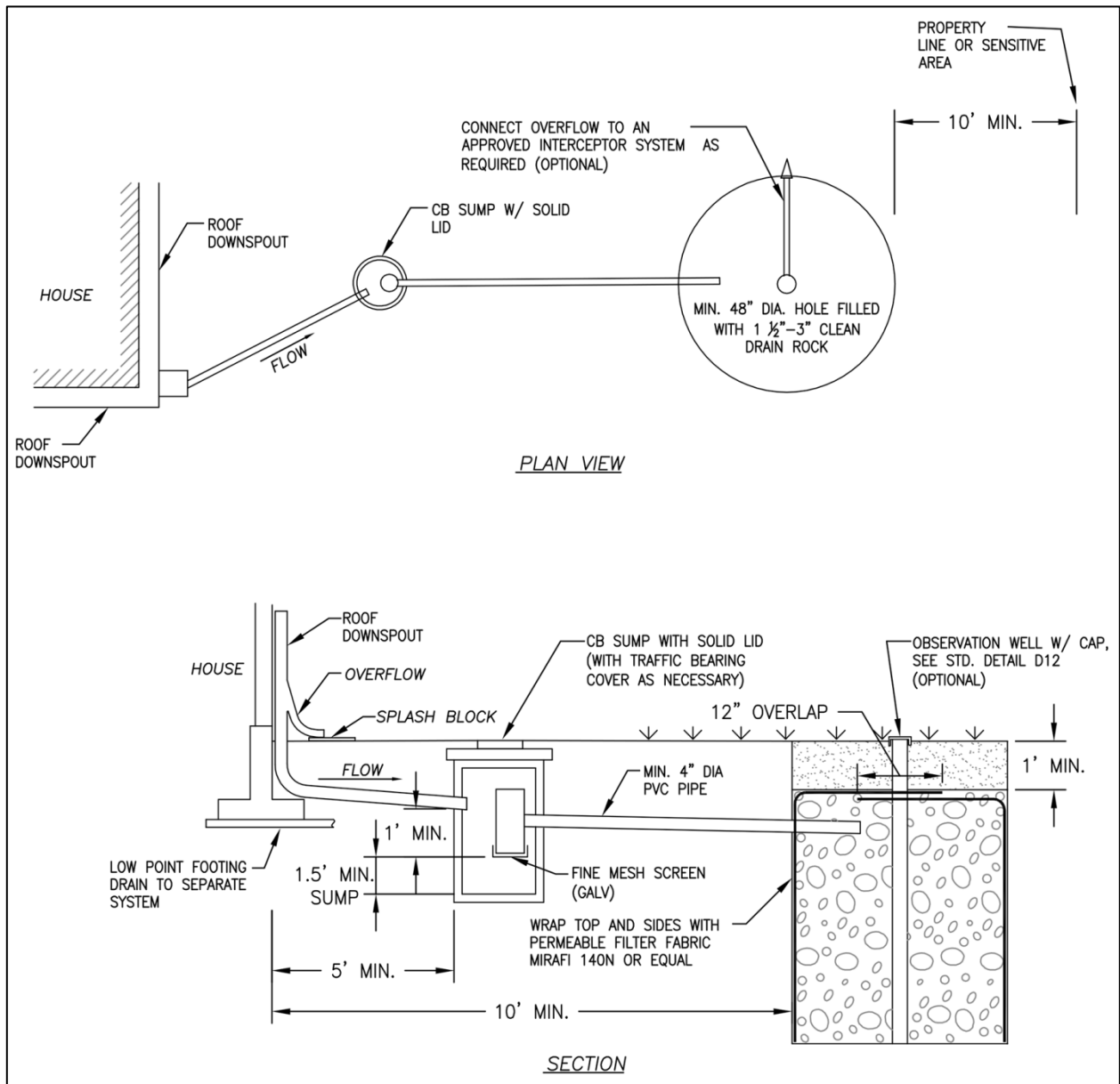
- 100 feet from closed or active landfills.
- 10 feet from any sewage disposal drain field, including reserve areas and grey water reuse systems.
- 100 feet up gradient from any septic system unless site topography clearly prohibits subsurface flows from intersecting the drain field.
- 10 feet from an underground storage tank and its connecting pipes that is used to store petroleum products, chemical, or liquid hazardous wastes in which 10% or more of the storage volume of the tank and connecting pipes is beneath the ground.
- 10 feet from any structure, property line, or sensitive area (except slopes over 40%). However, if the roof downspout infiltration system is a common system shared by two or more adjacent residential lots and contained within an easement for maintenance given to owners of all residential properties draining to the system, then the setback from the property line(s) shared by the adjacent lots may be waived.

## Design Criteria

- Drywell bottoms must be a minimum of 1 foot above seasonal high groundwater level or impermeable soil layers
- Drywells shall contain a minimum volume of gravel:
  - If located in coarse sands and cobbles (defined as a particle size of 2mm or greater in accordance with ASTM D422-63 particle size analysis), at least 60 cubic feet of gravel per 1,000 square feet of impervious surface served.
  - If located in medium sands (defined as 0.5 mm to 2 mm in accordance with ASTM D422-63 particle size analysis), at least 90 cubic feet of gravel per 1,000 square feet of impervious surface served.
- Drywells shall be at least 4 feet in diameter and deep enough to contain the gravel amounts specified above for the soil type and impervious surfaced served.
- Choking stone or filter fabric (geotextile) shall be placed on top of the drain rock and filter fabric shall be placed on drywell sides prior to backfilling. Filter fabric shall not be placed on the bottom.
- Spacing between drywells shall be a minimum of 10 feet.
- A geotechnical analysis and report is required on slopes over 15% or if located within 200 feet of the top of slope steeper than 40%, or in a landslide hazard area.

## Runoff Modeling Representation

- If roof runoff is infiltrated according to the requirements of this section, the roof area may be removed from the project area used for sizing stormwater facilities.



**Figure 2.1: Typical Downspout Infiltration Drywell**

(Source: modified from Clark County)

## BMP T5.10B: Downspout Full Infiltration – Infiltration Trenches

---

### Purpose and Description

Infiltration trenches are trenches fill with rock and containing perforated pipe that are designed to infiltrate runoff from roof downspout drains. They cannot be used to directly infiltrate runoff from pollutant-generating surfaces. Alternatives to rock-filled trenches, such as preformed chambers, are acceptable if equivalent storage volume is provided.

### Cross Reference Guide

See [BMP T5.10A](#), Downspout Full Infiltration - Drywells

### Applications, Limitations and Setbacks

Geotechnical analysis is an important first step to determining the feasibility of using downspout infiltration trenches. The required site analysis includes an initial assessment of the type of site soils, and the infiltration potential. See [Section 2.3 in Book 1](#) for guidance regarding required site soils analysis.

Roof downspout infiltration trenches are deemed feasible without infiltration testing when a qualified professional determines that USDA textural classes consisting of coarse sand to medium sand, loam, or cobbles and gravels are present in the infiltration zone. If other soils are present in the infiltration zone consider a rain garden or bioretention facility instead.

Items that make roof downspout infiltration trenches infeasible include:

- Less than one foot of clearance exists between the proposed bottom of the trench and the seasonal high groundwater table.
- The downspout full infiltration system cannot meet the setbacks specified below.
- The downspout full infiltration system cannot meet the design criteria specified below.

### Setbacks

- See [BMP T5.10A](#) for setback information.

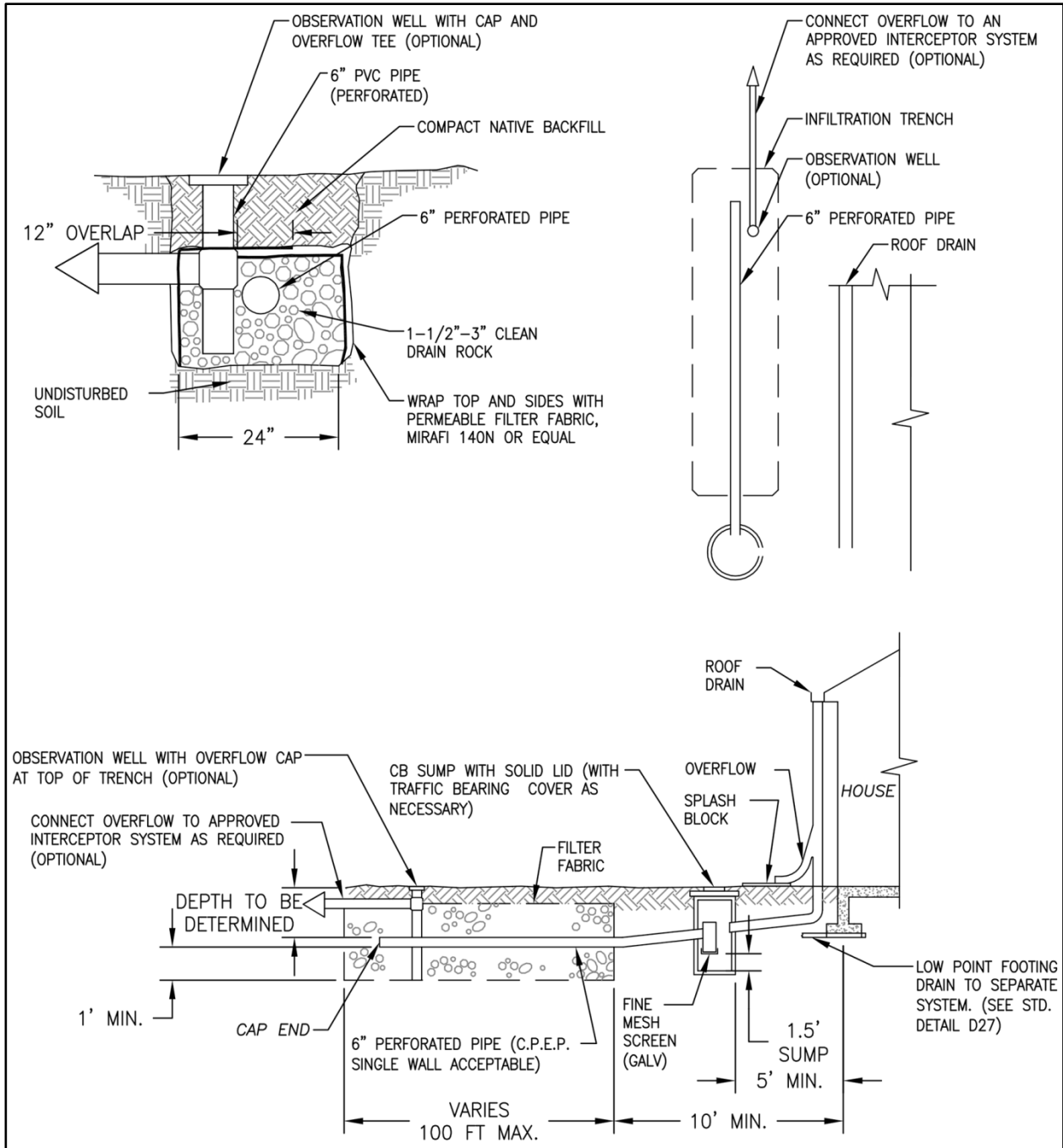
### Design Criteria

- The following minimum lengths per 1,000 square feet of roof area based on soil type may be used for sizing downspout infiltration trenches:
  - Coarse sands and cobbles: 20 linear feet
  - Medium Sand: 30 linear feet
  - Fine sand, loamy sand: 75 linear feet.

- Sandy loam: 125 linear feet
- Loam: 190 linear feet
- Maximum length of trench is 100 feet from the inlet sump. If the minimum length is greater than 100 feet, flow should be split into parallel trenches.
- Minimum spacing between parallel trench centerlines is 6 feet.
- Filter fabric shall be placed over the drain rock prior to backfilling. Filter fabric should not be used where it can impede the flow into the soil.
- Infiltration trenches may be placed in fill material if the fill is placed and compacted under the direct supervision of a geotechnical engineer or professional civil engineer with geotechnical expertise, and if the measured hydraulic conductivity of the compacted fill material is at least 8 inches per hour. Trench length in fill shall be 60 linear feet per 1,000 square feet of roof area.
- Infiltration trenches should not be built on slopes steeper than 25%.
- A geotechnical analysis and report is required on slopes over 15% or if located within 200 feet of the top of slope steeper than 40%, or in a landslide hazard area.
- Choking stone or filter fabric (geotextile) shall be placed on top of the drain rock and filter fabric shall be placed on trench sides prior to backfilling. Filter fabric shall not be placed on the bottom of the trench.

### Runoff Modeling Representation

If roof runoff is infiltrated according to the requirements of this section, the roof area may be removed from the project area used for sizing stormwater facilities.



**Figure 2.2: Typical Downspout Infiltration Trench**

(Source: modified from Clark County)

## BMP T5.10C: Downspout Dispersion

---

### Purpose and Description

Downspout dispersion systems are splash blocks or gravel-filled trenches, which serve to spread roof runoff over vegetated pervious areas. These BMPs reduce peak flows and provide some infiltration and water quality benefits. The primary difference between a dispersion trench and a full infiltration trench is that the dispersion trench can be used in any soil type because overflow is expected.

### Cross Reference Guide

Soils Assessment	NA
Meets Minimum Requirements	#5
Related BMPs	None
Selection Criteria	<a href="#">Book 1, Sections 2.2 and 2.5.1</a>
Maintenance	<a href="#">Book 4</a>

### Applications, Limitations and Setbacks

Downspout dispersion where feasible, must be used in lots where downspout full infiltration, full dispersion, and bioretention/rain gardens are not feasible.

#### Setbacks

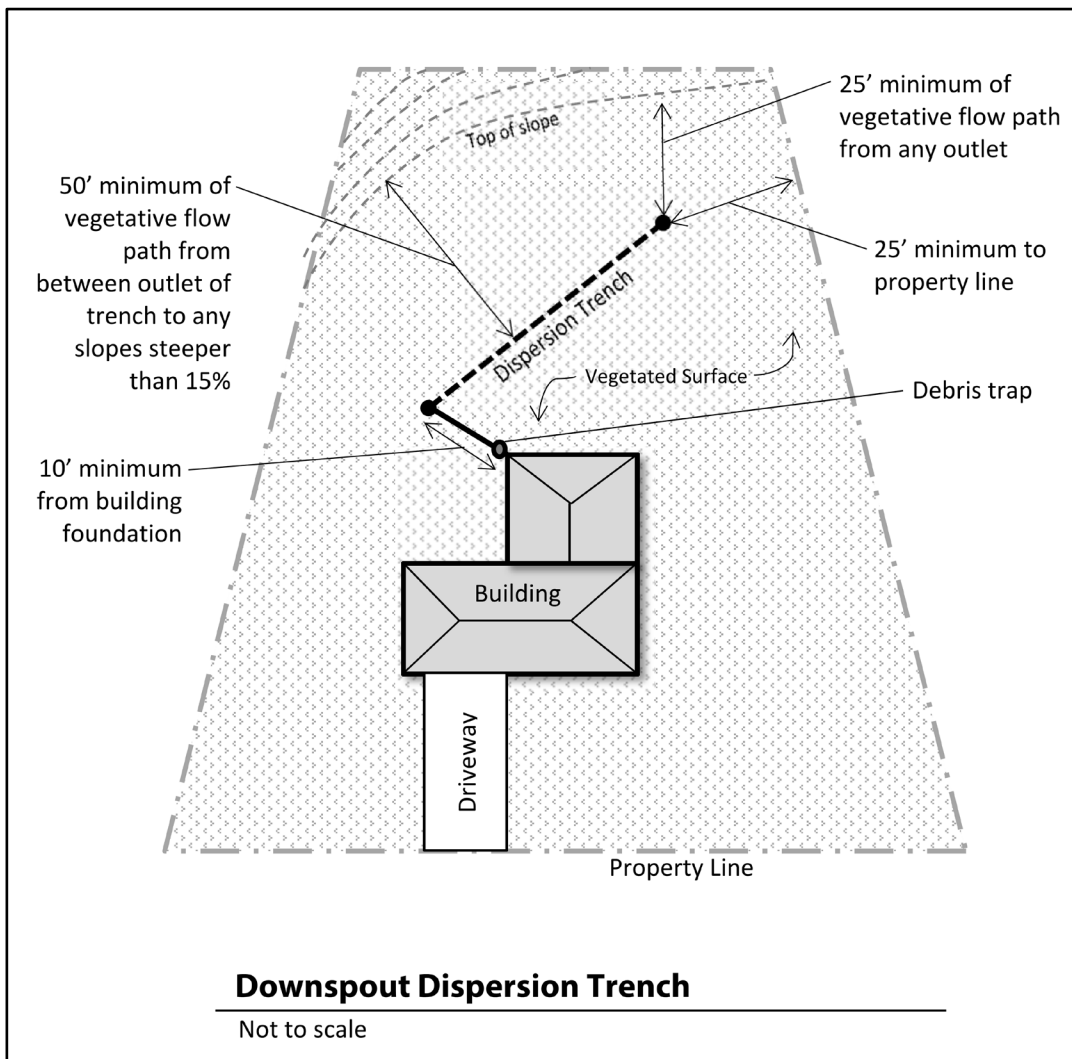
- 10 feet from any sewage disposal drainfield, including reserve areas and grey water reuse systems.
- 100 feet upgradient from any septic system unless site topography clearly indicates that subsurface flows will not intersect the drainfield.
- 10 feet from any structure, property line, or sensitive area.
- 50 feet from the top of any slope over 15%. This setback may be reduced to 15 feet based on a geotechnical evaluation.

### Design Criteria

#### Dispersion Trenches

- A vegetated flow path of at least 25 feet shall be maintained between the outlet of the trench and any property line, structure, stream, wetland, or impervious surface.

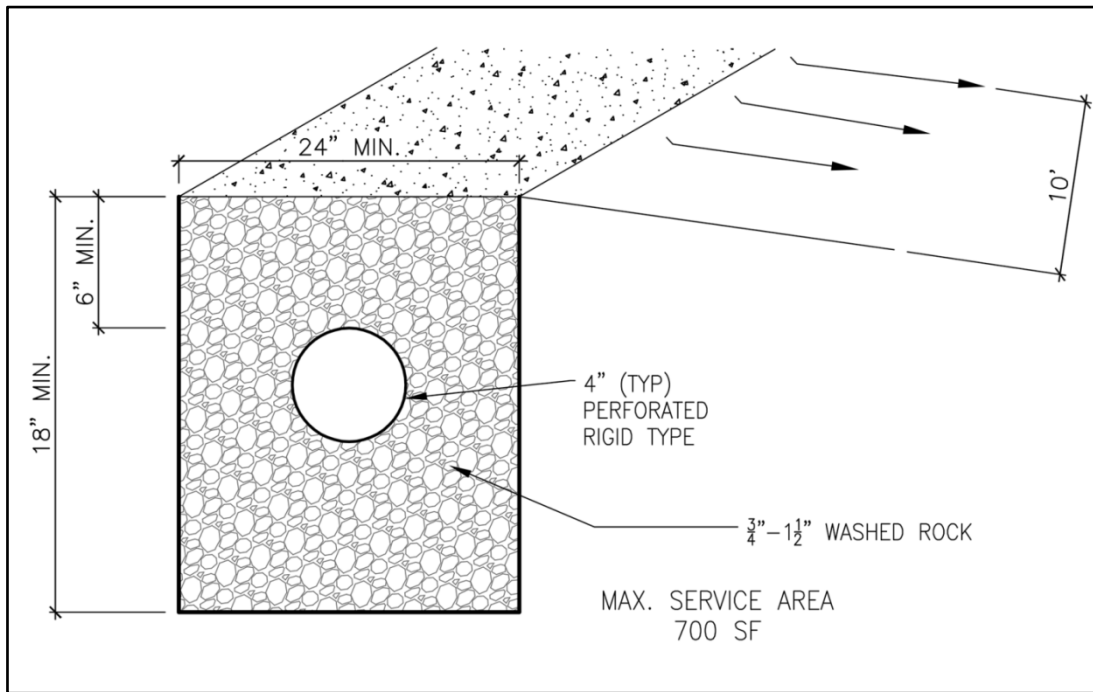
- A vegetated flow path of at least 50 feet in length shall be maintained between the outlet of the trench and any slope steeper than 15%. Sensitive area buffers may count towards flow path lengths.
- Trenches serving up to 700 square feet of roof area shall be at least 10 feet long by 2 feet wide.
- For roof areas larger than 700 square feet, a dispersion trench with notched grade board or alternative material approved by Clark County may be used. The total length of this design shall not exceed 50 feet and shall provide at least 10 feet of trench length per 700 square feet of roof area.
- No erosion or flooding of downstream properties may result.



**Figure 2.3: Typical Downspout Dispersion Trench Site Plan**

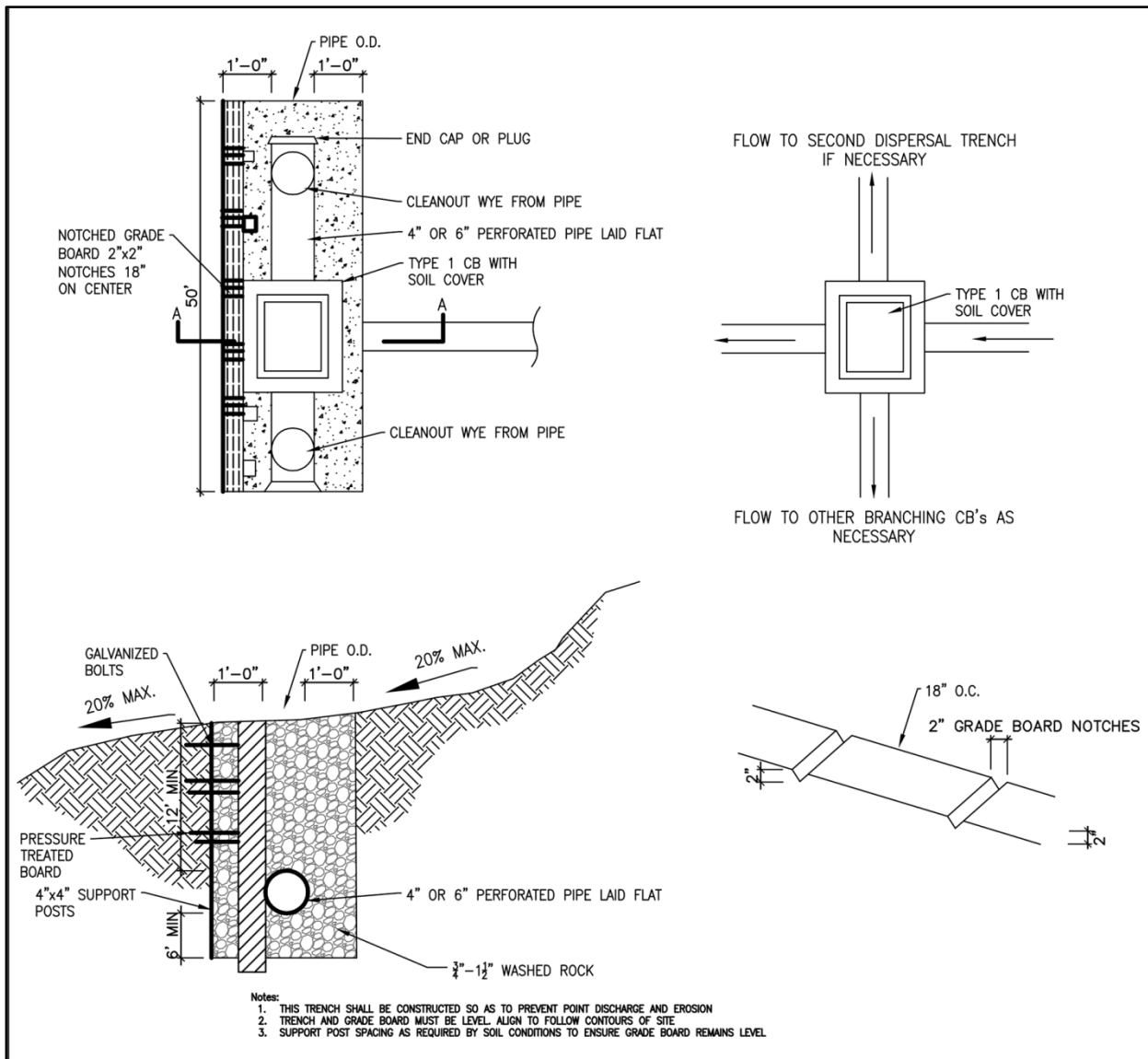
(Source: Clark County)





**Figure 2.4: Downspout Dispersion Trench Cross-Section**

(Source: modified from Department of Ecology)



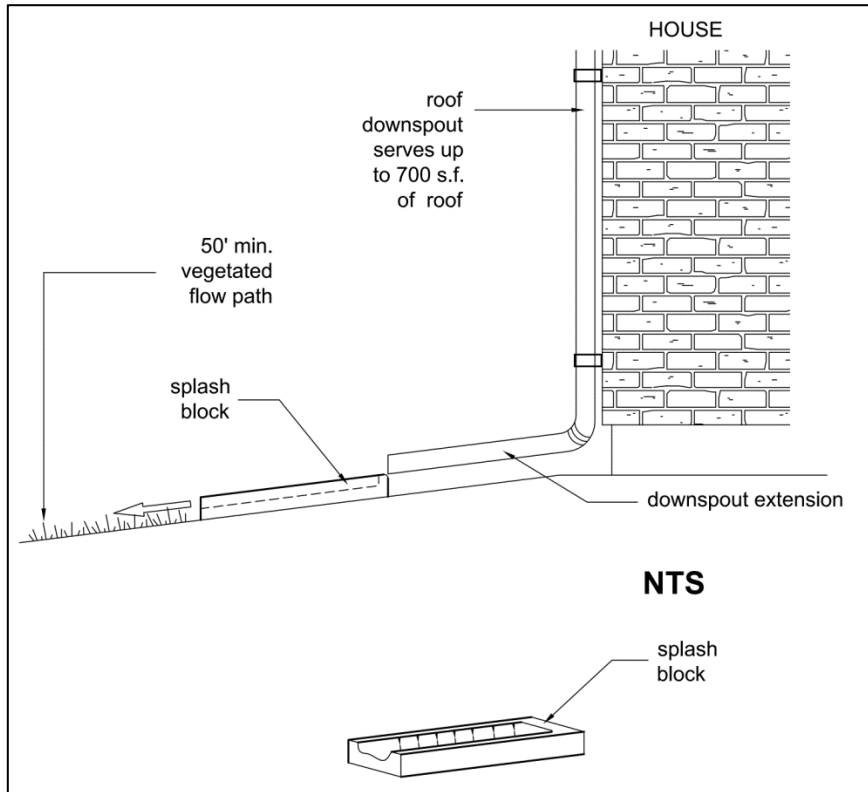
**Figure 2.5: Dispersion Trench with Notched Grade Board**

(Source: modified from Department of Ecology)

### Splashblocks

- A vegetated flow path of at least 50 feet shall be maintained between the discharge point and any property line, structure, slope steeper than 15%, stream, wetland, lake, or other impervious surface. Sensitive area buffers may count toward flow path lengths.
- Each splashblock shall drain a maximum area of 700 square feet.
- For purposes of maintaining adequate separation of flows discharged from adjacent dispersion devices, the vegetated flow path segment for the splashblock shall not overlap with other flow path segments, except those associated with sheet flow from a constructed pervious surface.

- A splashblock or a pad of crushed rock (2 feet wide by 3 feet long by 6 inches deep) shall be placed at each downspout discharge point.
- No erosion or flooding of downstream properties shall result.



**Figure 2.6: Typical Splashblock**

(Source: redrawn from King County Surface Water Design Manual 2009)

## Runoff Modeling Representation

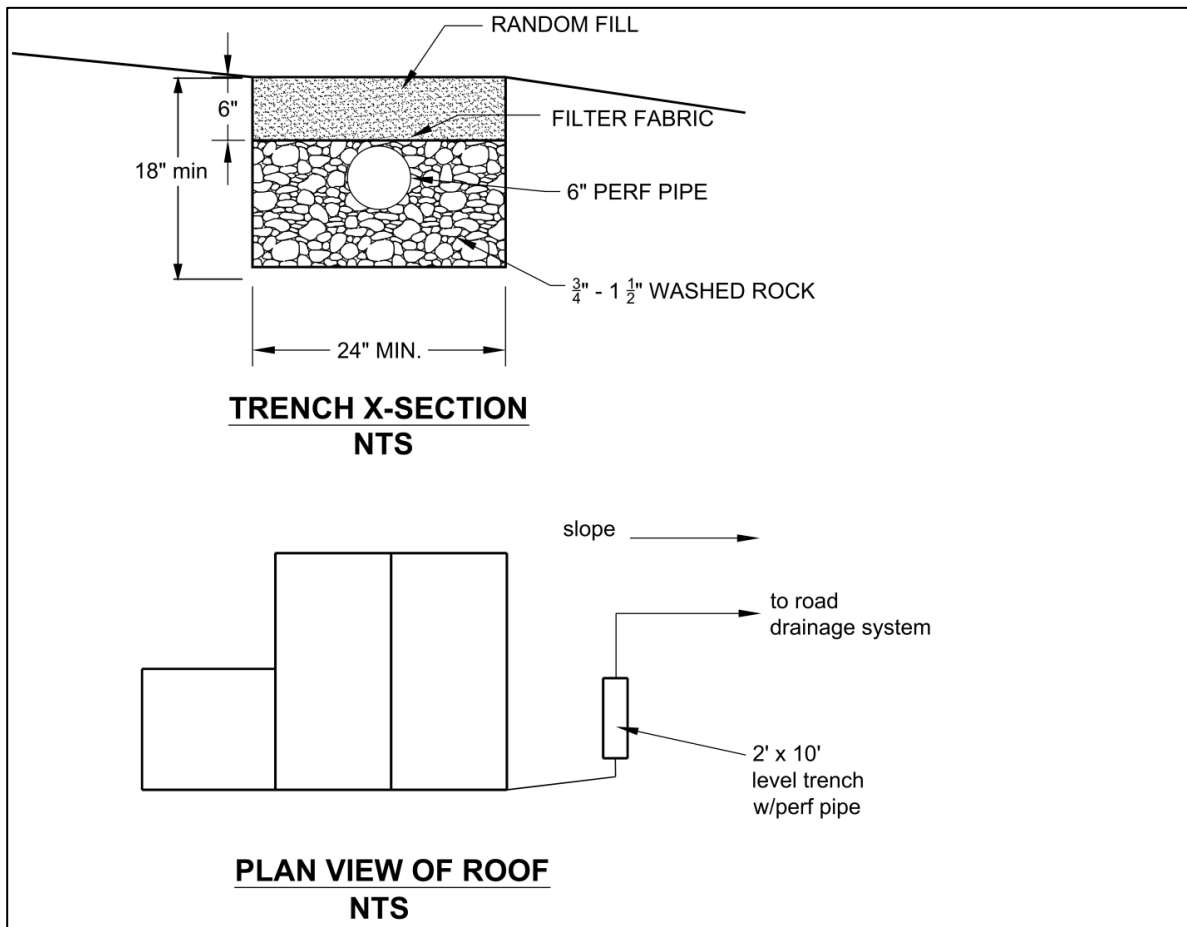
Where [BMP T5.10C](#) disperses runoff into an undisturbed native landscape area or an area that meets [BMP T5.13](#) Soil Quality and Depth, and the vegetated flow path is at least 50 feet, the connected roof area should be modeled as a lateral flow impervious area. Do this in WWHM on the Mitigated Scenario screen by connecting the dispersed impervious area to the lawn/landscape lateral flow soil basin element representing the area that will be used for dispersion.

Ecology may develop guidance for representing multiple downspout dispersions in a project site. Until that time, in situations where multiple downspout dispersions will occur, the roof area can be modeled as a landscaped area (where the 50 foot flow path requirement is met), or as 50% landscape/50% lawn (where a gravel trench is used to disperse into a vegetated area with a 25 to 50 foot flow path) so that the project schematic in the approved continuous flow model is manageable.

## BMP T5.10D: Perforated Stub-out Connections

### Purpose and Description

A perforated stub-out connection is a length of perforated pipe within a gravel-filled trench that is placed between roof downspouts and a stub-out to the local drainage system. This BMP provides some infiltration during drier months. During the wet winter months, they may provide little or no flow control.



**Figure 2.7: Typical Perforated Stub-out Connection**

(Source: King County Surface Water Design Manual 2009)

Cross Reference Guide

Soils Assessment	NA
Meets Minimum Requirements	#5
Related BMPs	None
Selection Criteria	<a href="#">Book 1, Sections 2.2 and 2.5.1</a>
Maintenance	<a href="#">Book 4</a>

**ADD:**  
 Perforated stub outs do not provide pretreatment. Perforated stub outs are not allowed to drain into a subsurface detention or retention facility without first connecting to a pretreatment BMP under Minimum Requirement #6.

Applications, Limitations and Setbacks

In projects subject to Minimum Requirement #5 perforated stub-out connections may be used only when all other higher priority on-site stormwater management BMPs are not feasible, per the criteria for each of those BMPs.

Perforated stub-outs cannot be used when the seasonal water table is less than one foot below trench bottom.

A perforated stub-out may also be used where implementation of downspout dispersion might cause erosion or flooding problems, either on site or on adjacent lots.

Select the location of the connection to allow a maximum amount of runoff to infiltrate into the ground (ideally a dry, relatively well drained, location). To facilitate maintenance, do not locate the perforated pipe portion of the system under impervious or heavily compacted (e.g., driveways and parking areas) surfaces.

Have a licensed geologist, hydrogeologist, or engineering geologist evaluate potential runoff discharges towards landslide hazard areas. Do not place the perforated portion of the pipe on or above slopes greater than 20% or above erosion hazard areas without evaluation by a professional engineer with geotechnical expertise or qualified geologist.

For sites with septic systems, the perforated portion of the pipe must be downgradient of the drainfield primary and reserve areas. This requirement can be waived if site topography will clearly prohibit flows from intersecting the drainfield or where site conditions (soil permeability, distance between systems, etc.) indicate that this is unnecessary.

Setbacks

Setbacks shall be the same as for downspout infiltration trenches provided in [BMP T5.10A](#).

## Design Criteria

- The BMP must have at least 10 feet of perforated pipe per 5,000 square feet of roof area, laid in a level, 2-foot wide trench backfilled with washed drain rock.
- The drain rock shall be extended to a depth of at least 8 inches below the bottom of the pipe and shall cover the pipe.
- The rock trench shall be covered with filter fabric and 6 inches of fill.

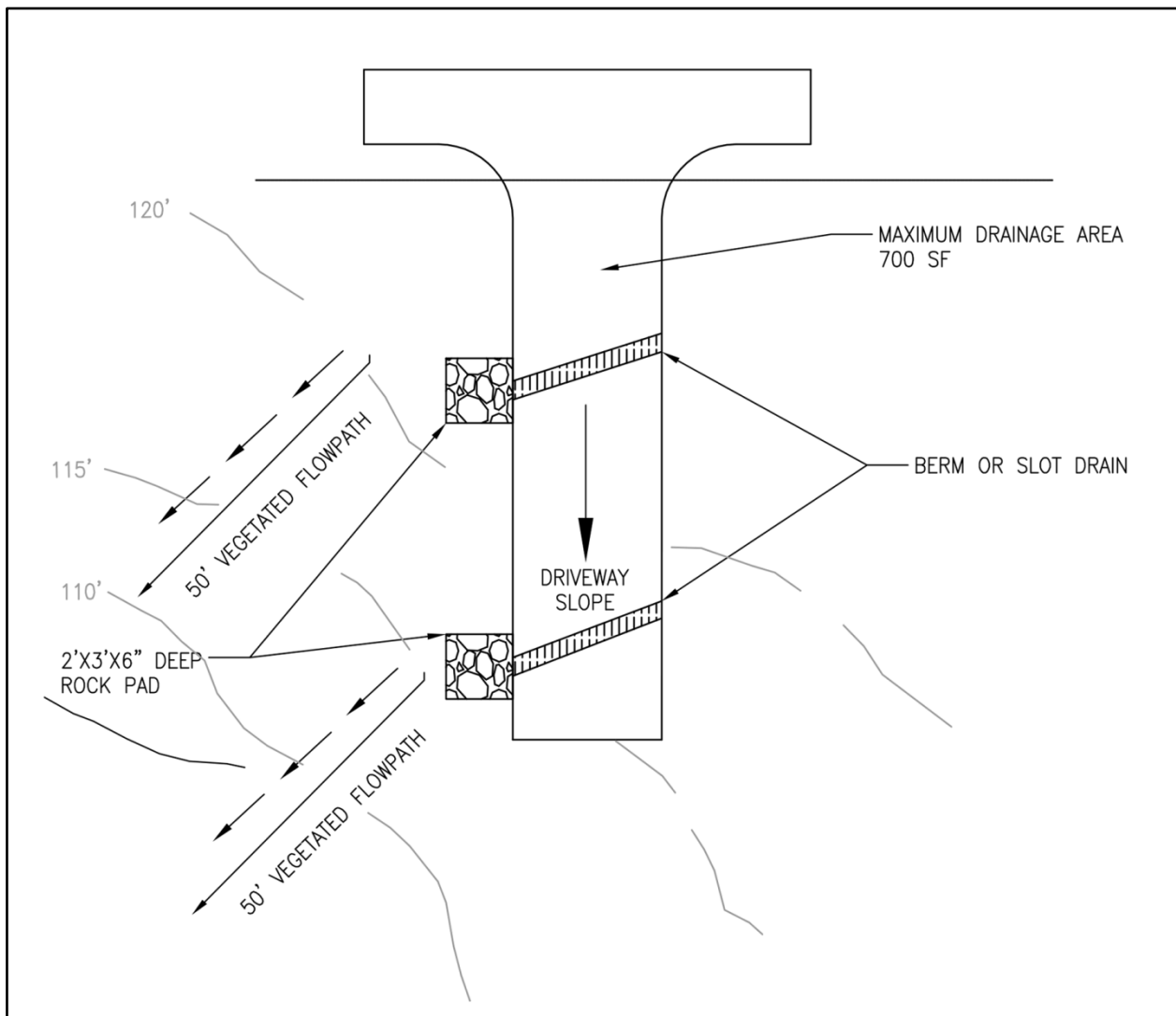
## Runoff Modeling Representation

Any flow reduction is variable and unpredictable. No computer modeling techniques are allowed that would predict any reduction in flow rates and volumes from the connected area.

## BMP T5.11: Concentrated Flow Dispersion

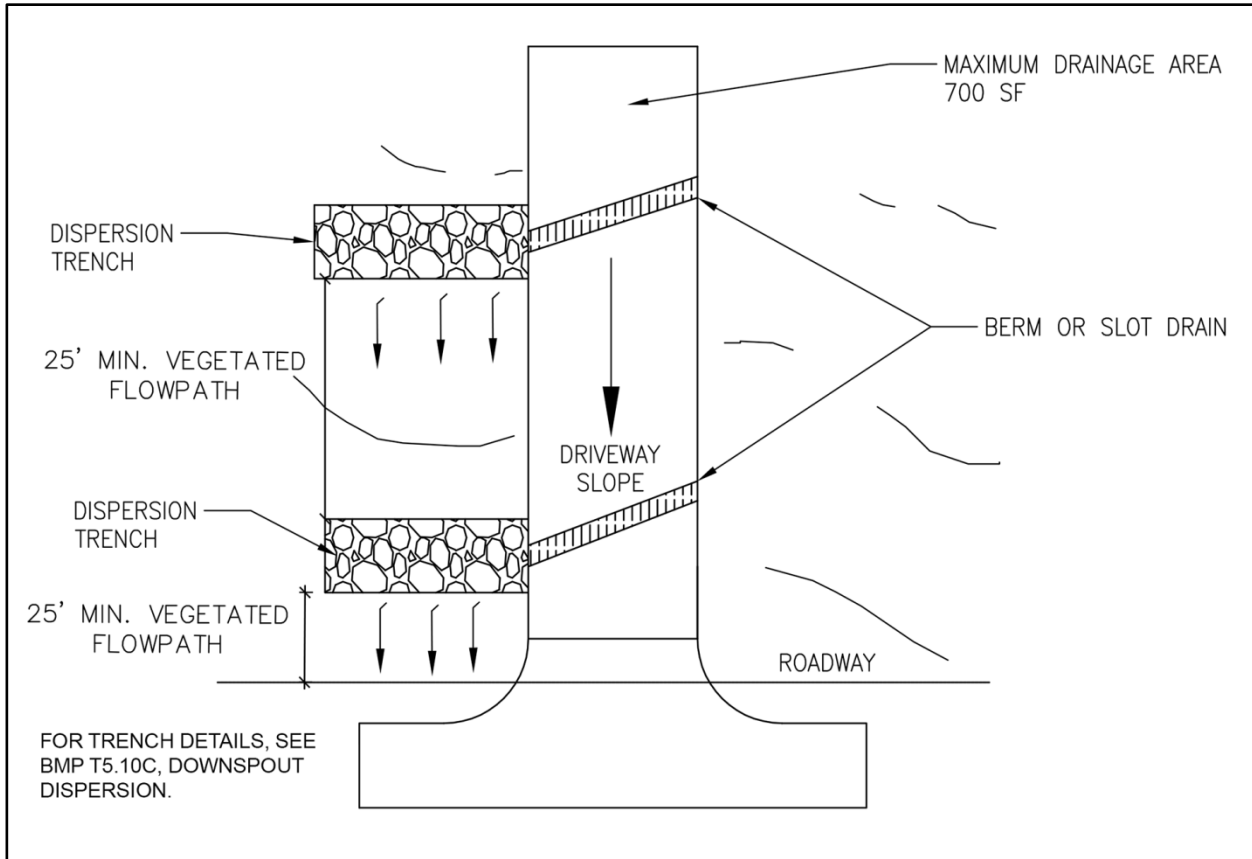
### Purpose and Description

Concentrated flow dispersion BMPs disperse flows from driveways or other pavements through a vegetated, pervious area. These BMPs reduce peak flows by slowing entry of the runoff into the downstream conveyance system, allowing for some infiltration, and providing some water quality benefits.



**Figure 2.8: Concentrated Flow Dispersion Using Rock Pad**

(Source: Clark County)



**Figure 2.9: Concentrated Flow Dispersion Using Dispersion Trench**

(Source: Clark County)

### Cross Reference Guide

Soils Assessment	NA
Meets Minimum Requirements	#5
Related BMPs	<a href="#">BMP T5.13</a>
Selection Criteria	<a href="#">Book 1, Sections 2.2 and 2.5.3</a>
Maintenance	<a href="#">Book 4</a>

### Applications, Limitations and Setbacks

Use this BMP in any situation where concentrated flow can be dispersed through the required length of vegetation.



### Setbacks

- 100 feet upgradient from any septic system unless site topography clearly indicates that subsurface flows will not intersect the drainfield.
- 10 feet from any structure, property line, or sensitive area.
- 50 feet from a geohazard area per CCC 40.430.

### Design Criteria

- Each Concentrated Flow Dispersion BMP can serve a drainage area up to 700 square feet.
- A vegetated flow path of at least 50 feet shall be maintained between the discharge point and any property line, structure, steep slope (>20%), stream, lake, wetland, lake, or other impervious surface, unless a dispersion trench is used.
- When a dispersion trench per [BMP T5.10C](#) is used, the vegetated flow path described above can be reduced to 25 feet. A pad of crushed rock (a minimum of 2 feet wide by 3 feet long by 6 inches deep) shall be placed at each discharge point unless a dispersion trench per [BMP T5.10C](#) is being used.
- No erosion or flooding of downstream properties shall result.
- Any runoff discharged towards landslide hazard areas shall be evaluated by a geotechnical engineer or qualified geologist. The discharge point shall not be placed on or above slopes greater than 20%, or above erosion hazard areas, without evaluation by a geotechnical engineer or qualified geologist and approval by Clark County.
- For sites with septic systems, the discharge point must be at least ten feet below the elevation of the drainfield primary and reserve areas. Clark County may waive this requirement during plan approval if site topography clearly prohibits flows from intersecting the drainfield.

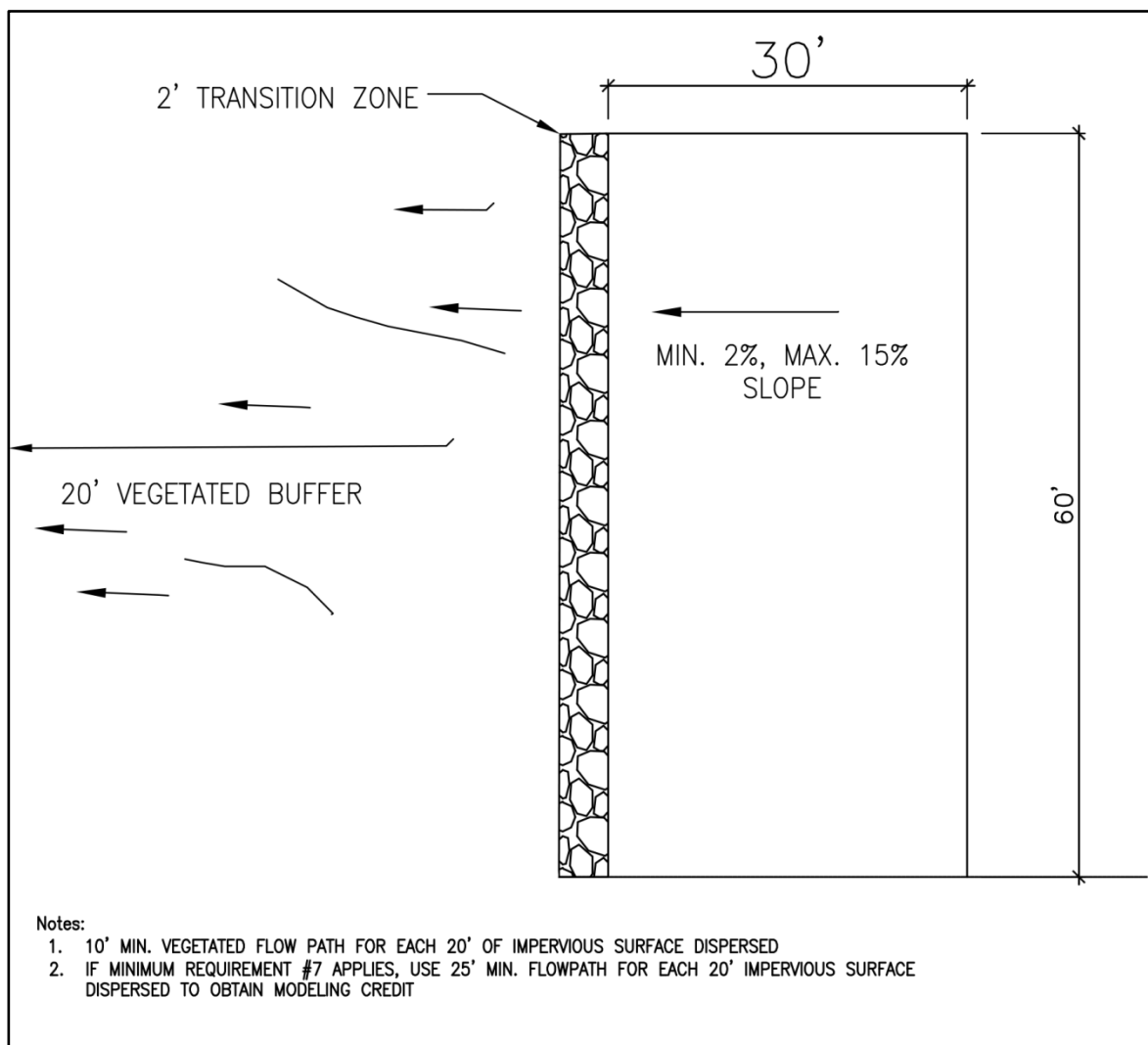
### Runoff Modeling Representation

Where [BMP T5.11](#)- Concentrated Flow Dispersion - is used to disperse impervious area runoff into an undisturbed native landscape area or an area that meets [BMP T5.13](#), and the vegetated flow path is at least 50 feet, the impervious area may be modeled as a landscaped area. Where the vegetated flow path is 25 – 50 feet, using a dispersion trench (see [BMP T5.10C](#)) allows modeling the impervious area as 50% impervious/50% landscape. Do this in WWHM 3 on the Mitigated Scenario screen by entering the dispersed impervious area into one of the entry options for dispersal of impervious area runoff. For procedures in WWHM 2012, see [Appendix 2-C](#).

## BMP T5.12: Sheet Flow Dispersion

### Purpose and Description

Sheet flow dispersion is the simplest method of runoff control. This BMP can be used for any impervious or pervious surface that is graded to avoid concentrating flows. Because flows are already dispersed as they leave the surface, they need only to traverse a narrow band of adjacent vegetation for effective attenuation and treatment.



**Figure 2.10: Sheet Flow Dispersion for Flat and Moderate Sloped Surfaces**

(Source: Clark County)

## Cross Reference Guide

Soils Assessment	NA
Meets Minimum Requirements	#5
Related BMPs	<a href="#">BMP T5.13</a>
Selection Criteria	<a href="#">Book 1, Sections 2.2 and 2.5.3</a>
Maintenance	<a href="#">Book 4</a>

## Applications, Limitations and Setbacks

Sheet Flow Dispersion is used on flat or moderately sloping (< 15% slope) surfaces such as driveways, sports courts, patios, roofs without gutters, lawns, pastures; or any situation where concentration of flows can be avoided.

Runoff discharge toward landslide hazard areas must be evaluated by a geotechnical engineer or a qualified geologist.

Sheet flow dispersion shall not be allowed on or above slopes greater than 20%, or above erosion hazard areas, without evaluation by a geotechnical engineer or qualified geologist and approval by Clark County.

### Setbacks

- 100 feet upgradient from any septic system unless site topography clearly indicates that subsurface flows will not intersect the drainfield.
- 10 feet from any structure, property line, or sensitive area.
- 50 feet from a geohazard area per CCC 40.430.

### Design Criteria

- A 2 foot-wide transition zone shall be maintained (to discourage channeling between the edge of the impervious surface and the downslope vegetation). This transition zone may consist of an extension of subgrade material (crushed rock), modular pavement, drain rock, or other material approved by Clark County.
- The sheet flow dispersion area must abut the entire edge of the impervious area being treated by the BMP.
- A 10 foot vegetated flow path must be provided for each 20 feet of impervious surface. For each additional 20 feet of impervious surface or fraction thereof, an additional 10 feet of vegetated

flow path must be provided. For example, if a driveway is 30 feet wide and 60 feet long, provide a 20-foot wide by 60-foot long vegetated buffer, with a 2-foot by 60-foot transition zone. See [Figure 2.10](#).

- No erosion or flooding of downstream properties shall result.
- Runoff discharge toward landslide hazard areas must be evaluated by a geotechnical engineer or a qualified geologist.
- Sheet flow dispersion shall not be allowed on or above slopes greater than 20%, or above erosion hazard areas, without evaluation by a geotechnical engineer or qualified geologist and approval by Clark County.
- For sites with septic systems, the discharge area shall be at least 10 feet below the elevation of the drainfield primary and reserve areas. Clark County may waive this requirement during plan approval if site topography clearly prohibits flows from intersecting the drainfield.

## Runoff Modeling Representation

Where [BMP T5.12](#) is used to disperse runoff into an undisturbed native landscape area or an area that meets [BMP T5.13](#), and the vegetated flow path is 50 feet or more, the impervious area may be modeled as landscaped area. Where the vegetated flow path is 25 to 50 feet, use of a dispersion trench (see [BMP T5.10B](#)) allows modeling the impervious area as 50% impervious/50% landscape. This is done in the WWHM3 on the Mitigation Scenario screen by entering the dispersed impervious area into one of the entry options for dispersal of impervious area runoff.

## BMP T5.13: Post-Construction Soil Quality and Depth

---

### Purpose and Description

Naturally occurring (undisturbed) soil and vegetation provide important stormwater functions including: water infiltration; nutrient, sediment, and pollutant adsorption; sediment and pollutant biofiltration; water interflow storage and transmission; and pollutant decomposition. These functions are largely lost when development strips away native soil and vegetation and replaces it with minimal topsoil and sod. Not only are these important stormwater functions lost, but such landscapes themselves become pollution generating pervious surfaces due to increased use of pesticides, fertilizers and other landscaping and household/industrial chemicals, the concentration of pet wastes, and pollutants that accompany roadside litter. Establishing soil quality and depth regains greater stormwater functions in the post development landscape, provides increased treatment of pollutants and sediments that result from development and habitation, and minimizes the need for some landscaping chemicals, thus reducing pollution through prevention.

### Cross Reference Guide

Soils Assessment	NA
Meets Minimum Requirements	#5
Related BMPs	None
Selection Criteria	<a href="#">Book 1, Sections 2.2 and 2.5.2</a>
Maintenance	<a href="#">Book 4</a>

### Applications, Limitations and Setbacks

Establishing a minimum soil quality and depth is not the same as preservation of naturally occurring soil and vegetation. However, establishing a minimum soil quality and depth will provide improved onsite management of stormwater flow and water quality. Soil organic matter can be attained through addition of numerous materials such as compost, composted woody material, biosolids, and forest product residuals. It is important that the materials used to meet the soil quality and depth BMP be appropriate and beneficial to the plant cover to be established. Likewise, it is important that imported topsoils improve soil conditions and do not have an excessive percent of clay fines. This BMP can be considered infeasible on slopes greater than 33 percent.

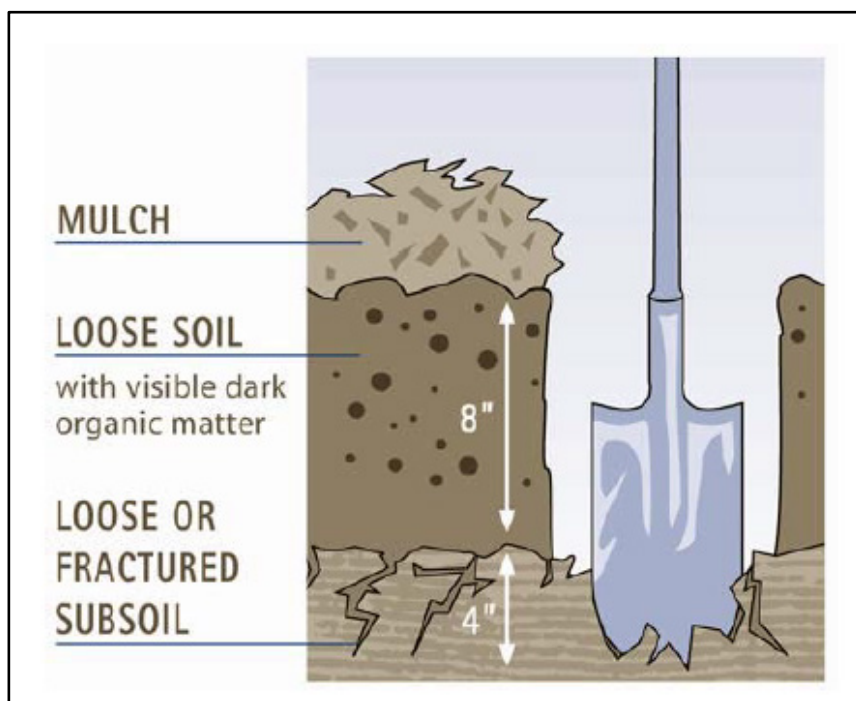
Soil and vegetation provide significant benefits, including:

- Water infiltration.
- Absorption of nutrients, sediments and pollutants.

- Biofiltration of sediment and pollutants.
- Water interflow storage and transmission.
- Pollutant decomposition.

These functions are largely lost when development strips away native soil and vegetation and replaces it with minimal topsoil and sod. Establishing in-situ soil quality and depth regains greater stormwater functions in the post development landscape and also minimizes the need for some landscaping chemicals, further limiting pollution.

This BMP is mandatory for all projects required to follow Minimum Requirements #1 – #5 or Minimum Requirements #1 – #9.



**Figure 2.11: Typical Planting Bed Cross-section**

(Source: Washington Organic Recycling Council graphic in SMMWW)

## Design Criteria

- Retain, in an undisturbed state, the duff layer and native topsoil to the maximum extent practicable. In any areas requiring grading remove and stockpile the duff layer and topsoil on site in a designated, controlled area, not adjacent to public resources and critical areas, to be reapplied to other portions of the site where feasible.
- Areas subject to clearing and grading that have not been covered by hard surfaces, used for a drainage facility, or where the soils have been engineered as structural fill or slope, shall demonstrate the following after completion of the project:

- A topsoil layer with:
  - A minimum organic matter content of 10% dry weight in planting beds.
  - 5% organic matter content in turf areas.
  - A pH from 6.0 to 8.0 or matching the pH of the undisturbed soil.
  - A minimum topsoil layer depth of 8 inches except where tree roots do not allow this.
- Subsoils below the topsoil layer should be scarified at least 4 inches with some incorporation of the upper material to avoid stratified layers, where feasible.
- Mulch planting beds with 2 inches of organic material.
- Compost and other materials shall meet the following requirements for organic content:
  - The organic content for pre-approved (by Ecology) amendment rates can be met only using compost meeting the compost specification for Bioretention (~~BMP T7.30~~ [BMP T5.14B](#)), with the exception that the compost may have up to 35% biosolids or manure. The compost must also have an organic matter content of 40% to 65%, and a carbon to nitrogen ratio below 25:1. The carbon to nitrogen ratio may be as high as 35:1 for plantings composed entirely of plants native to the Portland/Vancouver region.
  - Calculated amendment rates may be met through use of composted material meeting (a.) above; or other organic materials amended to meet the carbon to nitrogen ratio requirements, and not exceeding the contaminant limits identified in Table 220-B, Testing Parameters, in [WAC 173-350-220](#).
- The resulting soil should be conducive to the type of vegetation to be established.
- Only one of these methods can be used to meet the above criteria for a specific area on the site:
  - Native vegetation and soil should remain undisturbed and protected from compaction during construction.
  - Amend existing topsoil or subsoil either at default “pre-approved” rates, or at custom calculated rates based on soil tests of the soil and amendments.
  - Stockpile existing topsoil during grading and replace it over disturbed areas prior to planting. Stockpiled topsoil must also be amended if needed to meet the organic matter or depth requirements, either at a default “pre-approved” rate or at a custom calculated rate.
  - Import topsoil mix of sufficient organic content and depth to meet the requirements.
  - More than one method may be used on different portions of the same site. Soil that already meets the depth and organic matter quality standards need not be amended.

- Scarification of subsoils can be accomplished using mechanical methods such as a rototiller.

## Runoff Modeling Representation

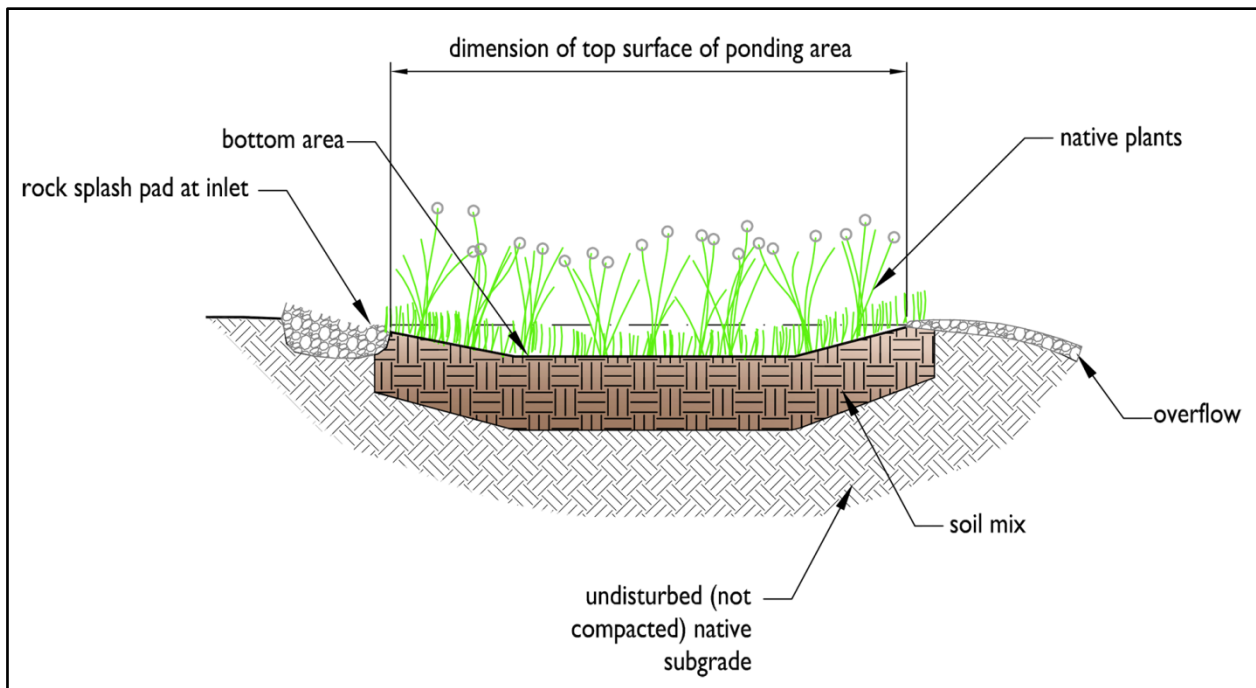
- Areas meeting the design guidelines may be entered into approved runoff models as “Pasture” rather than “Lawn.”
- Flow reduction credits can be taken in runoff modeling when [BMP T5.13](#) is used as part of a dispersion design under the conditions described in:
  - [BMP T5.10C](#) Downspout Dispersion
  - [BMP T5.11](#) Concentrated Flow Dispersion
  - [BMP T5.12](#) Sheet Flow Dispersion
  - [BMP T5.18](#) Reverse Slope Sidewalks
  - [BMP T5.30A](#) Full Dispersion (for public road projects)



## BMP T5.14A: Rain Gardens

### Purpose and Description

Rain gardens are typically small, non-engineered shallow depressions with amended soils and adapted plants. Rain gardens remove stormwater that fills the depression via infiltration into the native soil, while excess stormwater overflows into an adjacent drainage system. Rain gardens are an on-site stormwater management BMP option only for projects subject to Minimum Requirements #1 – #5.



**Figure 2.12: Typical Rain Garden Profile**

(Source: redrawn from Oregon State University Extension)

### Cross Reference Guide

Soils Assessment	<a href="#">Book 1, Section 2.3</a>
Meets Minimum Requirements	#5
Related BMPs	None
Selection Criteria	<a href="#">Book 1, Sections 2.2 and 2.5.4</a>
Maintenance	<a href="#">Book 4</a>

## Applications, Limitations and Setbacks

Rain gardens are an on-site stormwater management BMP option for projects that have to comply with Minimum Requirements #1 – #5, but they may not be used on sites complying with Minimum Requirements #1 – #9. For projects required to use List #1 of Minimum Requirement #5, Rain Gardens are to be used to the maximum extent feasible for runoff from roofs and other hard surfaces unless a higher priority BMP is feasible.

Rain gardens are generally used on smaller projects such as individual home sites where soils are not sufficiently well drained for roof downspout infiltration wells or trenches.

Rain garden are suitable for infiltration if the minimum measured coefficient of permeability is 0.3 in/hr or greater. See [Section 2.3 of Book 1](#) for more information on soil assessments conducted for rain gardens.

### Setbacks

- 50 feet from the top of slopes greater than 20% or with more than 10 feet of vertical relief.
- 100 feet from a landfill (active or closed).
- 100 feet from a drinking water well or a spring used for drinking water.
- 10 feet from any small on-site sewage disposal drain field, including reserve areas, and grey water reuse systems. For setbacks from a “large on-site sewage disposal system,” see [Chapter 246-272B WAC](#).
- From an underground storage tank and its connecting pipes that is used to store petroleum products, chemicals, or liquid hazardous waste in which 10% or more of the storage volume of the tank and connecting pipes is beneath the ground:
  - 10 feet when the system capacity is 1100 gallons or less.
  - 100 feet when the system capacity is greater than 1100 gallons.
- 100 feet from an area with known deep soil contamination.
- 10 feet from any property line or structure unless a qualified professional provides a written document stating that the structure will not be affected by the proposed location.

Because rain gardens can add phosphorus to stormwater from soil amendments and/or plant material:

- Imported compost shall not be used if the site is within 1/4 mile of a phosphorous-sensitive water body.
- An underdrain shall not be used if drainage would be routed to a phosphorous-sensitive waterbody.

## Design Criteria

*The design criteria and procedures in this section are adapted from the Rain Garden Handbook for Western Washington: A Guide for Design, Installation, and Maintenance (Ecology, 2013). Users may reference the handbook for additional design specifications and construction guidance. If information in the handbook conflicts with information in this manual, the information in this manual shall apply.*

### Site Considerations

Due to the geologic and topographical conditions in Clark County, not all sites are suitable for rain gardens. A rain garden should not:

- Be placed over existing utilities. Contact utility locate services in the early design stages.
- Be located in areas that would require disturbing healthy native soils, trees, and other vegetation—these areas already do a good job of filtering and storing stormwater.
- Be located where there is high groundwater during the winter. A minimum of one foot of separation is required between the lowest elevation of the rain garden soil or any underlying gravel infiltration layer and the seasonal high groundwater elevation or other impermeable layer.

### Pond Area

- The ponding depth must be 6” minimum and 12” maximum.
- The pond must have a flat and level bottom.
- The minimum freeboard measured from the maximum ponding water surface elevation to the top of the facility shall be 2” for drainage areas less than 1,000 square feet and 6” for drainage areas 1,000 square feet or greater.
- If a berm is used to achieve the minimum top elevation, maximum slope on berm shall be 2H:1V and minimum top width of design berm shall be 1 foot. Berm shall be a material which is water tight. Imported soil may be necessary to ensure berm does not fail. Berm shall be tightly packed during construction.

### Sizing Requirement and Procedure

Use this sizing procedure to determine the required area of the top surface of the pond. A rain garden built using this procedure will capture approximately 80% of the water that flows to it.

Size the top surface of the pond by applying a sizing factor determined using the steps below to the total contributing area flowing to the rain garden. If meeting Minimum Requirement #5, in no case shall the sizing factor be less than 5%.

1. Calculate the area of the contributing drainage in square feet.

- f. Include all types of surfaces draining to the rain garden including, but not limited to, roofs, driveways, patios, landscaping, and lawn.
2. At the location where the rain garden will be installed, find the infiltration rate of the soil following instructions in [Book 1, Section 2.3.1.4](#). (Note: the *Rain Garden Handbook*, cited above, describes a different procedure for determining soil infiltration rate which is not accepted by Clark County.)
  3. Determine the mean annual rainfall at the site (see map at [Figure 2.13](#)).
  4. Use [Table 2.1](#), below, and the information from steps 2 and 3, to determine the sizing factor.
  5. Multiply the contributing area and the sizing factor to find the top surface area of the pond (see [Figure 2.12](#) for an illustration of the top surface of the ponding area).

**Table 2.1: Rain Garden Sizing Factors**

Average Annual Precipitation (In.)	Soil Infiltration Rate				
	0.10 – 0.24 inches/hour <sup>1</sup>	0.25 – 0.49 inches/hour <sup>2</sup>	0.50 – 0.99 inches/hour	1.00 – 2.49 inches/hour	2.5 or more inches/hour
< 30	8%	7%	7%	6%	6%
30 - 40	14%	10%	8%	6%	6%
40 - 50	16%	11%	8%	7%	6%
50 – 70	19%	12%	10%	7%	6%
70 – 90	23%	15%	11%	9%	6%
> 90	28%	18%	13%	10%	7%

---

<sup>1</sup> At these low drainage rates, the maximum ponding depth is 6 inches. A 12-inch pond will not drain down quickly enough.

<sup>2</sup> If meeting Minimum Requirement #5, a rain garden is not required if the infiltration rate is less than 0.30 inches/hour.

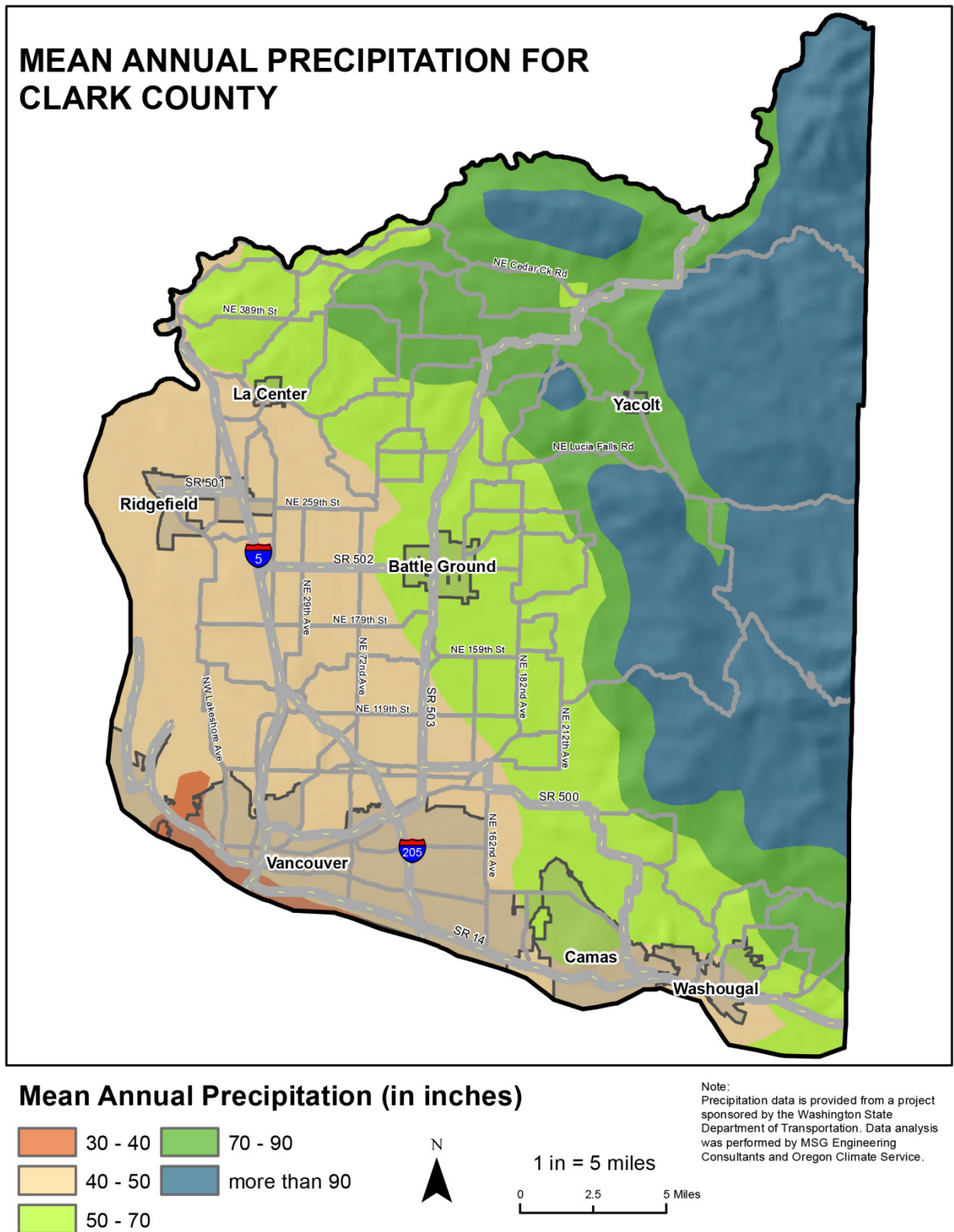


Figure 2.13: Mean Annual Precipitation in Clark County

## Flow Entrances

- Dispersed across a landscaped area. For sheet flow into a rain garden, include at least a 1 inch drop from the edge of the contributing impervious surface. This drop is intended to allow for less frequent maintenance due to sediment/debris buildup.
- Dispersed through an open swale. For slopes greater than 2%, add rock check dams every 5 to 10 feet to slow water flow.
- Pipe flow entrance. Place a rock pad where stormwater enters the rain garden from a swale or pipe. It is recommended to use washed round rock that is a minimum of 2 inches in diameter. Rock pad should be 4" thick and 2 feet wide and extend 2 feet to reduce potential for erosion at the inlet.
- Do not place plants directly in the entrance flow path as they can restrict or concentrate flows.
- Install flow diversion and erosion control measures to protect the rain garden from sedimentation until the upstream area is stabilized.

## Overflow

- Provide an overflow pathway lined with a 4" thick washed rock pad. Washed rock shall be a minimum of 2 inches in diameter. Extend overflow 4 feet past rain garden edge.
- Overflow shall not be directed to structures, neighboring properties, or over sidewalks.
- Overflow shall not cause damage to downstream properties or receiving waters.
- The minimum freeboard from the invert of the overflow stand pipe, horizontal drainage pipe or earthen channel shall be 6 inches.

## Soil Mix

Rain garden soil mix is the medium that supports plant growth and allows water to infiltrate downward into the undisturbed native subgrade (see [Figure 2.12](#)). Rain garden soil mix is usually a mix of topsoil and compost or sand and compost.

Place rain garden soil mix to a depth of between 12 inches and 24 inches.

There are three methods to achieve a proper rain garden soil mix.

### Method 1: Excavate and Replace Soil

Excavate the full depth and replace existing soil with a rain garden soil mix. A rain garden soil mix typically contains about 60% sand and 40% compost by volume.

Use this method if:

- Clay content is greater than 5% (infiltration rate is less than 0.24 inches per hour).

- In gravel soils as plant growth will be inhibited (infiltration rates typically above 2.5 inches per hour).

### Method 2: Excavate and Amend Topsoil with Compost

Excavate the rain garden and amend the removed topsoil with compost using 65% excavated soil to 35% compost.

Use this method if soils have a moderate infiltration rate (0.25 to 0.49 inches per hour).

### Method 3: Amend Topsoil in Place

Excavate to the ponding depth plus 3 inches. Amend soil in place by spreading 3 inches of compost and tilling to depth of 4 to 5 inches to fully incorporate compost.

Use this option only if the infiltration rate is 1 inch per hour or greater in soil that supports plant growth.

*Rain garden soil mixes may be available at local landscape suppliers or nurseries.*

### Compost

Compost used to amend soils should have the following characteristics:

- Be stable and mature (capable of supporting plant growth) and made from organic waste materials.
- Have an earthy, non-sour smell.
- Be brown to black in color.
- Be a crumbly texture with mixed particle sizes.
- Be a stable temperature. Do not use mushroom compost, un-composted manure, pure bark, biosolids, or sawdust.

### **Planting**

In general, the predominant plant material used in rain gardens are species adapted to stresses associated with wet and dry conditions. Soil moisture conditions will vary within the facility from saturated (bottom of cell) to relatively dry (rim of cell). The minimum requirements associated with the vegetation design include the following:

- The plants must be sited according to sun, soil, wind, and moisture requirements of the plant.
- Plants shall have a maximum mature plant height of 3 feet to minimize the need for extensive pruning that could impact the function of the rain garden in future years.

- Select plants based on suitability for maintenance, including factors such as minimal pruning needs and minimal plant debris (e.g. fruits, bark).
- Minimize plantings around the inlet and outlet to maintain desired water flow.
- At a minimum, provisions must be made for supplemental irrigation during the first two growing seasons following installation.

**Table 2.2: Plant List for Rain Garden\***

<b>Moist to Wet Soil Conditions (Facility Bottom to Bottom of Overflow)</b>				
<b>Type</b>	<b>Botanical Name</b>	<b>Common Name</b>	<b>O.C. Spacing</b>	<b>Allowed ROW**</b>
Herbaceous	<i>Carex densa</i>	Dense sedge	12”	Y
Herbaceous	<i>Carex morrowii</i>	Ice Dance	12”	Y
Herbaceous	<i>Carex obnupta</i>	Slough Sedge	12”	N
Herbaceous	<i>Deschampsia cespitosa</i>	Tufted Hair Grass	12”	N
Herbaceous	<i>Juncus patens</i>	Spreading Rush	12”	Y
Shrub	<i>Cornus sericea</i> ‘Kelseyii’	Kelsey Dogwood	24”	Y
Shrub	<i>Spiraea betulifolia</i>	Birchleaf Spiraea	24”	N
Shrub	<i>Spiraea densiflora</i>	Sub-alpine Spiraea	24”	Y
Shrub	<i>Spiraea japonica</i>	Japanese spirea cultivars	24”	Y
Groundcover	<i>Rubus calycinoides</i> & <i>pentalobus</i>	Creeping Bramble	12”	N
Accent	<i>Camassia leichtinii</i>	Great Camas	12”	N
Accent	<i>Camassia quamash</i>	Common Camas	12”	N
Tree	<i>Acer campestre</i> ‘Evelyn’	Elizabeth Hedge Maple	30’	Y
Tree	<i>Betula jacquemontii</i>	Jacquemontii Birch	60’	N
Tree	<i>Celtis occidentalis</i>	Hackberry	50’	N
Tree	<i>Koelreuteria paniculata</i>	Goldenrain Tree	30’	Y



Tree	<i>Nyssa sylvatica</i>	Black tupelo	50'	Y
Tree	<i>Prunus virginiana</i> 'Canada Red'	Canada Red Chokecherry	25'	Y
Tree	<i>Quercus shumardii</i>	Shumard Oak	70'	Y
Tree	<i>Rhamnus purshiana</i>	Cascara	30'	N
<b>Dry Soil Conditions (Overflow and Above)</b>				
<b>Type</b>	<b>Botanical Name</b>	<b>Common Name</b>	<b>O.C. Spacing</b>	<b>Allowed ROW</b>
Herbaceous	<i>Deschampsia cespitosa</i>	Tufted Hair Grass	12"	N
Herbaceous	<i>Helictotrichon sempervirens</i>	Blue Oat Grass	12"	Y
Shrub	<i>Cornus sericea</i> 'Kelseyii'	Kelsey Dogwood	24"	Y
Shrub	<i>Euonymus japonicas</i> 'Microphyllus'	Boxleaf Evergreen	24"	Y
Shrub	<i>Mahonia aquifolium</i> 'Compacta'	Oregon Grape	24"	Y
Shrub	<i>Spiraea betulifolia</i>	Birchleaf Spiraea	24"	N
Shrub	<i>Spiraea densiflora</i>	Sub-alpine Spiraea	24"	Y
Shrub	<i>Spiraea japonica</i>	Japanese spirea cultivars	24"	Y
Groundcover	<i>Arctostaphylos uva-ursi</i>	Kinnickinnick	12"	Y
Groundcover	<i>Fragaria chiloensis</i>	Coastal Strawberry	12"	Y
Groundcover	<i>Mahonia repens</i>	Creeping Oregon Grape	12"	N
Accent	<i>Camassia leichtinii</i>	Great Camas	12"	N
Accent	<i>Camassia quamash</i>	Common Camas	12"	N
Tree	<i>Acer campestre</i> 'Evelyn'	Elizabeth Hedge Maple	30'	Y
Tree	<i>Celtis occidentalis</i>	Hackberry	50'	N
Tree	<i>Koeleruteria paniculata</i>	Goldenrain Tree	30'	Y

Tree	<i>Prunus virginiana</i> 'Canada Red'	Canada Red Chokecherry	25'	Y
Tree	<i>Quercus shumardii</i>	Shumard Oak	70'	Y
Tree	<i>Rhamnus purshiana</i>	Cascara	30'	N
<p>Selected plants shall not include any plants from the State of Washington Noxious Weed List. Refer to <a href="http://www.clark.wa.gov/environmental-services/vegetation-management">www.clark.wa.gov/environmental-services/vegetation-management</a> for a current list of noxious weeds.</p> <p>*Adapted from Portland Bureau of Environmental Services 2014 <i>Stormwater Management Manual</i>, Appendix F.4., Planting Templates and Plant Lists</p> <p>** Plant species allowed in Clark County street Rights of Way</p>				

### Mulch Layer

Rain garden facilities should be designed with a mulch layer. Properly selected mulch material reduces weed establishment, regulates soil temperatures and moisture, and adds organic matter to the soil

- Mulch should be free of weed seeds, soil, roots, and other material that is not trunk or branch wood and bark. Mulch shall not include grass clippings, mineral aggregate, pure bark, or beauty bark. Mulch should be coarse mulch.
- Mulch should be wood chip mulch composed of shredded or chipped hardwood or softwood, depth 2-3 inches. Additional rain garden depth will be needed to ensure appropriate ponding and freeboard.
- A dense groundcover can be used as an alternative to mulch although mulch should be used until the dense groundcover is established.

### General Construction Criteria

- Do not install media or excavate rain garden during soil saturation periods.
- Excavation and soil placement should be done from equipment operating adjacent to the facility – no heavy equipment should be operated in the facility to avoid compacting soils
- If equipment must be operated within the facility for excavation, use lightweight, low ground pressure equipment and scarify the base to reduce compaction upon completion. Do not use equipment on top of rain garden soil mix.
- Do not use fully excavated rain garden for erosion and sedimentation control during construction
- Scarify sides and bottom to roughen where equipment may have compacted soil.

- Clogged soil and silt shall be removed during excavation to finished bottom grade prior to installing rain garden soil mix
- Ensure the rain garden is protected from erosion and sedimentation until all contributory areas are fully stabilized.
- If sedimentation occurs within the rain garden, excavate the area a minimum of 12 inches below final grade to remove sediment and replace media, mulch, and plants as necessary.

## BMP T5.14B: Bioretention Systems

---

### Purpose and Description

Bioretention refers to vegetated containment features (e.g., cells, swales, and planters) used to temporarily store stormwater prior to infiltration, evapotranspiration, or discharge via an underdrain or surface outlet structure. In contrast to rain gardens, bioretention facilities are engineered.

- Bioretention cells are shallow depressions, usually larger than rain gardens, with an engineered/designed mix of soil and a variety of plant species—trees, shrubs, grasses and/or other herbaceous plants. Bioretention cells are not designed as a conveyance system.
- Bioretention swales are similar to bioretention cells but swales are used as part of a conveyance system for stormwater when maximum ponding depth is exceeded. The ponding depth is generally 6 to 12 inches for bioretention swales.
- Bioretention planters and planter boxes feature a similar designed soil mix and variety of plant species within a vertical walled container usually constructed from formed concrete. Planters have an open bottom and allow infiltration to the subgrade. Planter boxes are completely impervious and include a bottom (must include an under-drain). These designs are often used in ultra-urban settings.

Removal of contaminants occurs primarily through filtration, shallow sedimentation, sorption, and infiltration. Additional removal mechanisms include biochemical processes in the underlying engineered planting media such as adsorption and microbial transformations of dissolved pollutants. Bioretention systems remove suspended solids, metals, oil and grease, nutrients, and bacteria, while also reducing volume and peak flow.

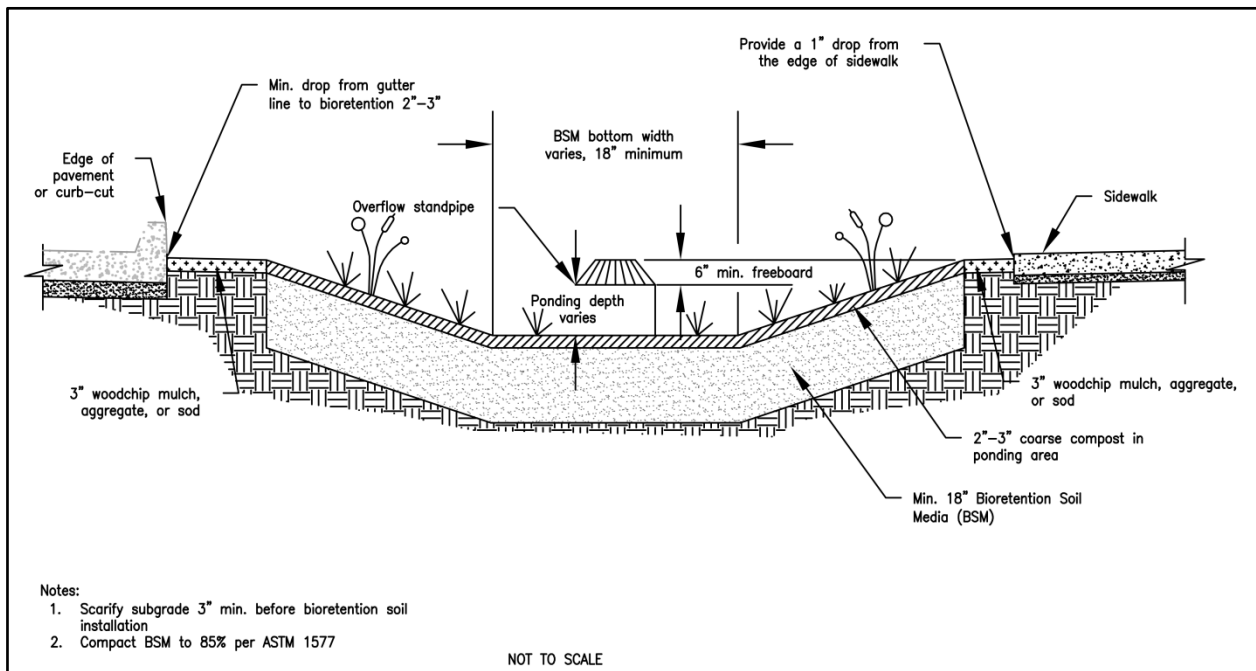
Primary bioretention features include:

- A rock pad at the inlet for energy dissipation.
- Shallow mulch layer at the surface.
- Medium thickness soil layer below the mulch.
- Optional stone storage layer below the engineered soil layer.
- Optional underdrain (needed when infiltration rates are low or infiltration is not desired).
- Overflow outlet.

For proposed bioretention locations, soil characterization studies and infiltration tests shall be conducted per [Section 2.3 of Book 1](#).

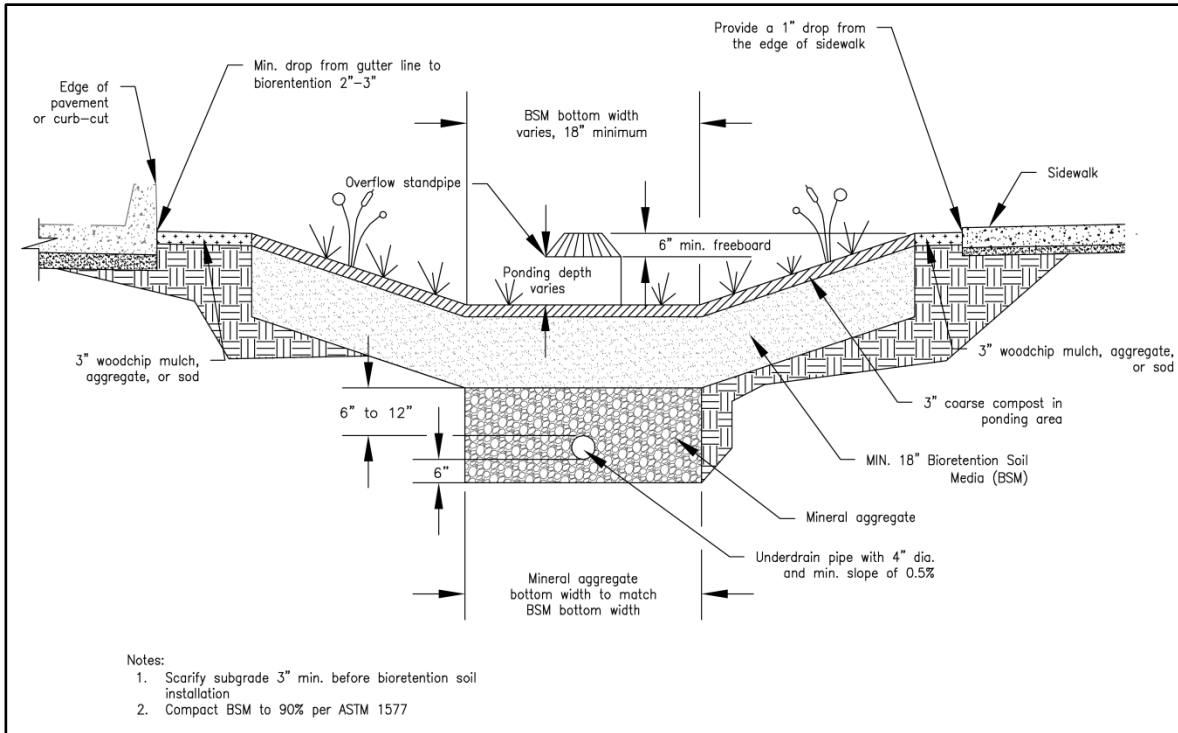
Cross Reference Guide

Soils Assessment	<a href="#">Book 1, Section 2.3</a>
Meets Minimum Requirements	#5, except designs with liners or non-elevated underdrains
Related BMPs	None
Selection Criteria	<a href="#">Book 1, Sections 2.2 and 2.5.4</a>
Maintenance	<a href="#">Book 4</a>



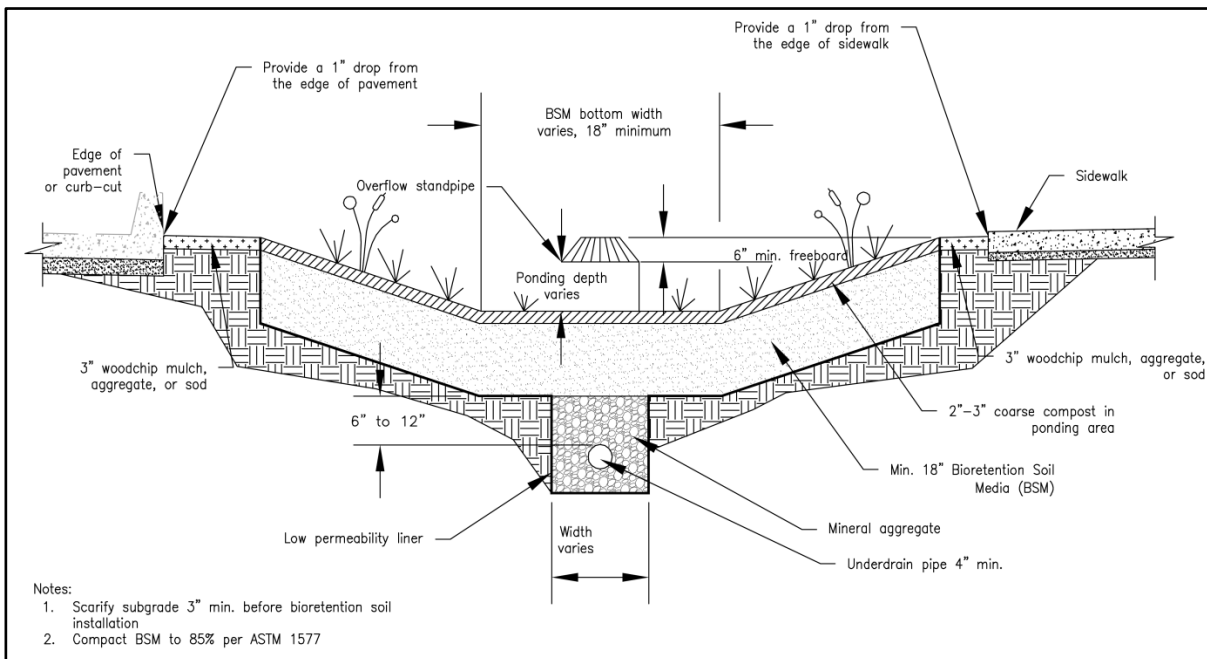
**Figure 2.14: Bioretention System Typical Cross-Section**

(Source: modified from Stormwater Management Manual for Western Washington, 2014)



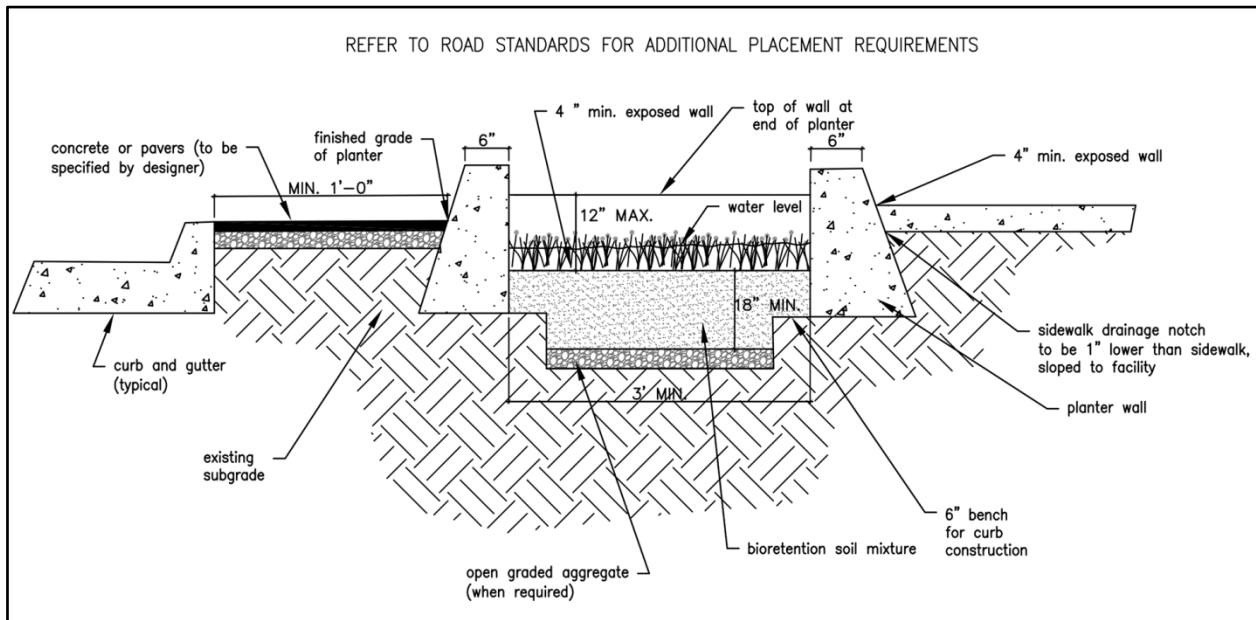
**Figure 2.15: Typical Bioretention with Underdrain**

(Source: modified from Stormwater Management Manual for Western Washington, 2014)



**Figure 2.16: Typical Bioretention with Underdrain and Liner – cannot meet MR #5**

(Source: modified from Stormwater Management Manual for Western Washington, 2014)



**Figure 2.17: Typical Bioretention Planter**

(Source: modified from Oregon State University Extension)

## Applications, Limitations and Setbacks

Bioretention facilities are an option for projects that only have to comply with Minimum Requirements #1 – #5 (List #1). For projects required to use List #2 of Minimum Requirement #5, bioretention facilities are to be used to the maximum extent feasible for runoff from roofs and other hard surfaces unless a higher priority BMP is feasible.

Because bioretention facilities use an imported soil mix that has a moderate design infiltration rate, they are best applied for small drainages, and near the source of the stormwater. Cells may be scattered throughout a subdivision; a swale may run alongside the access road; or a series of planter boxes may serve the road. In these situations, they can but are not required to fully meet the requirement to treat 91% of the stormwater runoff from pollution-generating surfaces. But the amount of stormwater that is predicted to pass through the soil profile may be estimated and subtracted from the 91% volume that must be treated. Downstream treatment facilities may be significantly smaller as a result.

Bioretention facilities that infiltrate into the ground can also serve a significant flow reduction function. They can, but are not required to fully meet the flow control duration standard of Minimum Requirement #7. Because they typically do not have an orifice restricting overflow or underflow discharge rates, they typically don't fully meet Minimum Requirement #7. However, their performance contributes to meeting the standard, and that can result in much smaller flow control facilities at the bottom of the project site. When used in combination with other low impact

development techniques, they can also help achieve compliance with the Performance Standard option of Minimum Requirement #5.

Bioretention facilities constructed with imported compost materials should not be used within one-quarter mile of phosphorus-sensitive waterbodies if the underlying native soil does not meet the criteria for treatment described in [Section 3.1.5.3](#). Bioretention should also not be used with an underdrain when the underdrain water would be routed to a phosphorus-sensitive receiving water. In Clark County, phosphorous treatment shall be provided in the Lacamas watershed above the dam at the south end of Round Lake for all project sites exceeding one (1) acre in size.

### Setbacks

- 50 feet from the top of slopes greater than 20% or with more than 10 feet of vertical relief.
- 100 feet from a landfill (active or closed).
- 100 feet from a drinking water well or a spring used for drinking water.
- 10 feet from any small on-site sewage disposal drain field, including reserve areas, and grey water reuse systems. For setbacks from a “large on-site sewage disposal system,” see [Chapter 246-272B WAC](#).
- From an underground storage tank and its connecting pipes that is used to store petroleum products, chemicals, or liquid hazardous waste in which 10% or more of the storage volume of the tank and connecting pipes is beneath the ground:
  - 10 feet when the system capacity is 1100 gallons or less.
  - 100 feet when the system capacity is greater than 1100 gallons.
- 100 feet from an area with known deep soil contamination.
- For a bioretention system that would serve a drainage area that is less than 5,000 sq. ft. of pollution-generating impervious surface and less than 10,000 sq. ft. of impervious surface, 10 feet from any structure or property lines.
- For a bioretention system that would serve a drainage area that is 5,000 sq. feet or more of pollution-generating impervious surface or 10,000 sq. ft. or more of impervious surface or  $\frac{3}{4}$  acres or more of pervious surfaces, 20 feet from the downslope side of any foundation, structure, or property line and 100 feet from the upslope side of any foundation. These setbacks may be increased or decreased based on engineering analysis that shows the performance of a building’s foundation system will not be adversely affected by the presence of the bioretention facility.

### Other Site Suitability Factors

- Utility conflicts: Observe horizontal and vertical separation required for utilities, such as water, sewer, communications, and gas. When separation requirements cannot be met, designs should include appropriate mitigation measures, such as impermeable liners over the utility, sleeving



utilities, fixing known leaky joints or cracked conduits, and/or adding an underdrain to the bioretention.

- **Transportation safety:** The design configuration and selected plant types should provide adequate sight distances, clear zones, and appropriate setbacks for roadway applications in accordance with county requirements.
- **Ponding depth and surface water draw-down:** Flow control needs, as well as location in the development, and mosquito breeding cycles will determine draw-down timing. For example, front yards and entrances to residential or commercial developments may require rapid surface dewatering for aesthetics.
- **Impacts of surrounding activities:** Human activity influences the location of the facility in the development. For example, locate bioretention areas away from traveled areas on individual lots to prevent soil compaction and damage to vegetation or provide elevated or bermed pathways in areas where foot traffic is inevitable. And provide barriers, such as wheel stops, to restrict vehicle access in roadside applications.
- **Visual buffering:** Bioretention facilities can be used to buffer structures from roads, enhance privacy among residences, and for an aesthetic site feature.
- **Site growing characteristics and plant selection:** Appropriate plants should be selected for sun exposure, soil moisture, and adjacent plant communities. Native species or hardy cultivars are recommended and can flourish in the properly designed and placed Bioretention Soil Mix with no nutrient or pesticide inputs and 2-3 years irrigation for establishment. Invasive species control may be necessary.

### Design Criteria

#### Flow Entrance and Pretreatment

- Flow velocities entering bioretention shall be less than 1.0 foot per second.
- Five types of entrance types can be used:
  - Dispersed low velocity flow over a landscape area.
  - Dispersed or sheet flow across pavement or gravel and past wheel stops for parking areas.
  - Curb cuts for roadside, driveway or parking lot areas:
    - Should include erosion protection.
    - Minimum drop from gutter line into bioretention: 2-3 inches.
    - Minimum curb cut width: 12 inches (18 inches recommended)
    - Where heavy trash/particulate loads are expected:
    - Catch basin may be necessary at flow entrance to capture debris/sediment load.

- Pipe flow entrance - should include erosion protection material to dissipate energy, disperse flow.
- Trench drains - can be used to cross sidewalks or driveways where there are elevation problems due to a deeper pipe conveyance. Additional maintenance may be required due to the tendency of trench drains to clog.
- Forebays and presettling are recommended for concentrated flow entrances (curb cuts, trench-drains, pipes) to reduce accumulation of sediment and trash. Catch basins or open forebays can be used for this.

### Bottom Area and Side Slopes

- The maximum planted side slope shall be 3H:1V (if total cell depth is greater than 3 feet).
- The minimum bottom width for bioretention swales shall be 18 inches.
- A minimum shoulder of 1 foot shall be used between the road edge and beginning of the bioretention side slope where flush curbs are used.
- Compaction effort for the shoulder shall be 90% Standard Proctor.

Vertical walls are allowable in bioretention facilities - specific requirements include:

- Maximum allowable height for total depth of facility (not just bottom of the wall) - Eighteen (18) inches maximum facility depth when vehicular or pedestrian traffic is adjacent to the facility. Vertical face on the vehicle side should meet clear zone requirements (this will allow vertical in the local access areas <25 mph but force a flatter slope and wider facility in collector and arterial settings).
- Width of facility; Minimum width of 3 feet when measured from wall face to back of curb for vertical walls and 2 foot bottom width for trapezoidal bioretention with a 3:1 typical side slopes.
- Adjacent features (i.e. sidewalk, parking, bike lane, roadway (design speed)) - adjacent features should be designed to the criteria for the element involved. (i.e. ADA requirements for sidewalks and ramps);
- Site specific design requirements for pedestrian use in/around the facility (i.e. installing pedestrian crossing points on longer bioretention facilities, use of railings, use of toe curbs; etc.) For heights above 6" top of wall to bottom of visible wall, include a minimum 4" height curb to minimize accidental entry. For heights above 24" top of wall to bottom of visible wall, include a fencing / rail system to limit pedestrian access into the facility. If the bioretention facility in a parking lot may alter pedestrian movement through the parking lot, consider adding an ADA compliant crossing of the bioretention facility to minimize entry into the bioretention facility.



**Figure 2.18: Example Pedestrian Rail System**

(Source: NYC Water flickr)

### Ponding Area

The following are recommendations for the ponded area:

- Maximum ponding depth of 1 foot.
- Surface pool drawdown time of 24 hours.

For design on projects subject to Minimum Requirement #5, and choosing to use List #1 or List #2 of that requirement, a bioretention facility shall have a horizontally projected surface area below the overflow (the top surface of the ponding area) which is at least 5% of the total area draining to it. The ponding area provides surface storage for storm flows, particulate settling, and the first stages of pollutant treatment within the cell. Pool depth and draw-down rate are recommended to provide surface storage, adequate infiltration capability, and soil moisture conditions that allow for a range of appropriate plant species. Soils must be allowed to dry out periodically in order to: restore hydraulic capacity to receive flows from subsequent storms; maintain infiltration rates; maintain adequate soil oxygen levels for healthy soil biota and vegetation; provide proper soil conditions for biodegradation and retention of pollutants. Maximum designed depth of ponding (before surface overflow to a pipe or ditch) must be considered in light of drawdown time.

For bioretention areas with underdrains, elevating the drain to create a temporary saturated zone beneath the drain is advised to promote denitrification (conversion of nitrate to nitrogen gas) and prolong moist soil conditions for plant survival during dry periods (see Underdrain section below for details).

## Surface Overflow

It is necessary to safely convey flows that exceed the capacity of the bioretention facility, in order to protect downstream natural resources and property. This can be provided by:

- Vertical stand pipes that are connected to underdrain systems (by horizontal drainage pipes or armored overflow channels installed at the designed maximum ponding elevations).
- A curb cut at the downgradient end, to direct overflows into the street.

The minimum freeboard from the invert of the overflow stand pipe, horizontal drainage pipe or earthen channel should be 6 inches.

## Bioretention Soil Mix (BSM)

### Standard BSM

Projects which use the following requirements for the bioretention soil media do not have to test the media for its coefficient of permeability (infiltration rate). They may assume the rates specified in the subsection titled “Determining Bioretention Soil Mix Infiltration Rate.”

The following are criteria for the standard bioretention soil mix (BSM):

- Minimum soil depth of 18 inches 60-65% mineral aggregate and 35-40% compost by volume.
- Organic matter: 5-8% by weight.
- Cation Exchange Capacity (CEC) must be at least 5 millequivalents per 100 grams of dry soil.
  - Soil mixes meeting the requirements of this section for mineral aggregate and organic matter composition need test for CEC as they will readily meet the CEC requirement.

- Mineral Aggregate:
  - Range of 2-5% passing 200 sieve, maximum 5% fines per ASTM D422.
  - Aggregate portion should be well-graded.
  - Coefficient of Uniformity (D60/D10) equal or greater to 4.
  - Coefficient of Curve (D302/D60/D10) between 1 and 3.
  - General Guideline for Mineral Aggregate Gradation:

Sieve Size	Percent Passing
3/8 inches	100
#4	95-100
#10	75-90
#40	24-40
#100	4-10
#200	2-5

- Compost:
  - Shall meet definition of “composted materials” in WAC 173-350-100, available online at <http://www.ecy.wa.gov/programs/swfa/organics/soil.html>.
  - Shall be produced at a composting facility permitted by the WA Department of Ecology.
  - Shall originate at least 65% by volume from recycled plant waste as defined as “Type I” in WAC 173-350-220. A current list of permitted facilities is available at <http://www.ecy.wa.gov/programs/swfa/organics/soil.html>.
  - Type II and Type IV feedstocks shall not be used in bioretention.
  - No visible free water or dust shall be produced when handling material.
  - Shall be tested in accordance with the US Composting Council “Testing Methods for the Examination of Compost and Composting” (TMECC).
  - Shall have a pH between 6.0 and 8.5.
  - Shall have a manufactured inert content less than 1%.
  - Shall have a minimum organic matter content of 40%.
  - Shall have a soluble salt content less than 4.0 mmhos per centimeter.
  - Shall have a maturity greater than 80% (TMECC 05.05-A “Germination and Vigor”).
  - Shall have stability of 7 or below (TMECC 05.08-B “Carbon Dioxide Evolution Rate”).

- Shall have a Carbon to Nitrogen ratio less than 25:1. May be up to 35:1 if planting composed entirely of Puget Sound Lowland native species or up to 40:1 for coarse compost used as a surface mulch (not in a soil mix).

Because bioretention can add phosphorus to stormwater from soil amendments and/or plant material, if the site is within ¼ mile of a phosphorus-sensitive waterbody, imported compost shall not be used unless underlying soils meet the criteria for treatment as described in [Section 3.1.5.3](#).

### Custom BSM

For a custom ~~BSM~~BSM, the requirements are:

- CEC at least 5 milliequivalents per 100 grams of dry soil.
- pH between 5.5 and 7.0.
- 5-8% organic matter before and after saturated hydraulic conductivity test.
- 2-5% fines passing #200 sieve.
- Measured (initial) hydraulic conductivity less than 12 inches per hour.
- Design (long-term) hydraulic conductivity greater than 1 inch per hour.
- If compost is used in creating the custom mix, it must meet all of the specifications listed above for compost.

### **BSM Infiltration Rate**

Option 1: If using the Bioretention Soil Mix recommended herein, the WWHM assumes a default infiltration rate of 12 inches per hour (15.24 cm/hr).

- ~~If the standard soil mix is used:~~
  - ~~1.5 3 inches per hour shall be used if the drainage area to the facility has over 10,000 square feet of impervious surface, over 5,000 ft<sup>2</sup> of pollution-generating impervious surface, the project converts at least ¾ acres of native vegetation to lawn/landscaping, or the project converts at least 2.5 acres of native vegetation to pasture.~~
  - ~~3 6 inches per hour may be used if none of the above criteria are exceeded.~~
- ~~If a custom soil mix is used:~~ [Add "Option 2" as noted on page 68, red box at bottom of page]
  - ~~Use ASTM D 2434 Standard Test Method for Permeability of Granular Soils (Constant Head) with a compaction rate of 85% using ASTM D1557 Test Method for Laboratory Compaction Characteristics of Soil Using Modified Effort.~~
  - ~~If the drainage area to the facility has over 10,000 ft<sup>2</sup> of impervious surface, over 5,000 ft<sup>2</sup> of pollution-generating impervious surface, the project converts at least ¾ acres of native vegetation to lawn/landscaping, or the project converts at least 2.5 acres of native vegetation to pasture, use 0.25 as the correction factor for the infiltration rate.~~
  - ~~If none of the above criteria are exceeded, 0.5 may be used as the infiltration rate correction factor.~~

### Underdrain (optional)

Where the underlying native soils have an estimated initial infiltration rate between 0.3 and 0.6 inches per hour, bioretention facilities without an underdrain, or with an elevated underdrain directed to a surface outlet, may be used to satisfy List #2 of Minimum Requirement #5.

Underdrained bioretention facilities that drain to a retention/detention facility must meet each of the following criteria if they are used to satisfy List #2 of Minimum Requirement #5:

- The invert of the underdrain must be elevated 6 inches above the bottom of the aggregate bedding layer. A larger distance between the underdrain and bottom of the bedding layer is desirable, but cannot be used to trigger infeasibility due to inadequate vertical separation to the seasonal high water table, bedrock, or other impermeable layer.
- The distance between the bottom of the bioretention soil mix and the crown of the underdrain pipe must be not less than 6 but not more than 12 inches.
- The aggregate bedding layer must run the full length and the full width of the bottom of the bioretention facility.
- The facility must not be underlain by a low permeability liner that prevents infiltration into the native soil.

The volume above an underdrain pipe in a bioretention facility provides pollutant filtering and minor detention. However, only the void volume of the aggregate below the underdrain invert and above the bottom of the bioretention facility (subgrade) can be used in the approved continuous flow model for dead storage volume that provides flow control benefit. Assume a 40% void volume for the aggregate filter and bedding layer specified below.

The underdrain can be connected to a downstream open conveyance, to another bioretention cell as part of a connected treatment system, daylight to a dispersion area using an effective flow dispersion practice, or to a storm drain.

- Because bioretention can add phosphorus to stormwater from soil amendments and/or plant material, an underdrain shall not be used if drainage would be routed to a phosphorus-sensitive waterbody.
- Underdrains should be installed only if the facility is:
  - Near sensitive infrastructure and flooding is likely.
  - Used for filtering storm flows from pollutant hotspots (such as gas stations).
  - Located above native soils with low infiltration rates.
  - In an area with insufficient depth to a hydraulic restriction layer (e.g. seasonal water table).
- The underdrain shall have the following design features:

- A minimum diameter of 4 inches.
  - A slotted subsurface drain shall be PVC pipe in accordance with WSDOT standard specification 9-05.2(6) Perforated PVC Underdrain Pipe. Perforated PVC underdrain pipe shall meet the requirements of AASHTO M 278. For Pipe larger than 8 inch diameter refer to section 9-05.(7) and 9-05.2(8).
  - Slots must be cut perpendicular to the long axis of the pipe and be 0.04 to 0.069 inches by 1 inch long and be spaced 0.25 inches apart. Slots should be arranged in four rows spaced on 45-degree centers and cover half the circumference of the pipe.
  - A minimum slope of 0.5% unless otherwise specified by an engineer.
- Perforated PVC or flexible slotted HDPE pipe cannot be cleaned with pressurized water or root cutting equipment, are less durable and are not allowed. Wrapping the under-drain pipe in filter fabric increases chances of clogging and is not allowed. A 6-inch rigid non-perforated observation pipe or other maintenance access should be connected to the under-drain every 250 to 300 feet to provide a clean-out port, as well as an observation well to monitor dewatering rates.

#### Under-drain Aggregate Filter and Bedding Layer

Aggregate filter and bedding layers buffer the under-drain system from sediment input and clogging. When properly selected for the soil gradation, geosynthetic filter fabrics can provide adequate protection from the migration of fines. However, aggregate filter and bedding layers, with proper gradations, provide a larger surface area for protecting under-drains and are preferred.

- Guideline for under-drain aggregate filter and bedding layers with heavy walled slotted pipe (see under-drain pipe guideline above): Use Gravel Backfill for Drains conforming to WSDOT Specification 9-03.12(4).
- Place under-drain on a bed of the aggregate with a minimum thickness of 6 inches and cover with aggregate to provide a 1-foot minimum depth around the top and sides of the slotted pipe.

#### Orifice and Other Flow Control Structures

- The minimum orifice diameter should be 0.5 inches to minimize clogging and maintenance requirements.

[This edit is the last bullet on page 66: Add the following verbiage]

Option 2: If creating a custom bioretention soil mix, Use ASTM D 2434 Standard Test Method for Permeability of granular Soils (Constant Head) with a compaction rate of 85 percent using ASTM D1557 Test Method for Laboratory Compaction Characteristics of Soil Using Modified Effort. The WWHM user must enter the derived value into WWHM using “View/Edit Soil Types” pull down menu and adjusting the Ksat value. After selecting option 1 or 2 above, determine the appropriate safety factor for the saturated hydraulic conductivity (Ksat). If the contributing area of the bioretention cell or swale is equal to or exceeds any of the following limitations: 5,000 square feet of pollution-generating impervious surface; 10,000 square feet of impervious surface; ¾ acre of lawn and landscape, use 4 as the infiltration rate (Ksat) safety factor. If the contributing area is less than all of the above areas, or if the design includes a pretreatment device for solids removal, use 2 as the Ksat safety factor. The WWHM has a field for entering the appropriate safety factor.



### Check Dams and Weirs

Check dams are necessary for reducing flow velocity and potential erosion, as well as increasing detention time and infiltration capability on sloped sites. Typical materials include concrete, wood, rock, compacted dense soil covered with vegetation, and hedge rows. Optimum spacing is determined by flow control benefit (modeling) in relation to cost consideration. See the *Low Impact Development Technical Guidance Manual for Puget Sound* for displays of typical designs.

### UIC Discharge

Stormwater that has passed through the bioretention soil mix may also discharge to a gravel-filled dug or drilled drain. Underground Injection Control (UIC) regulations are applicable and must be followed ([Chapter 173-218 WAC](#)). Refer to <https://fortress.wa.gov/ecy/publications/documents/0510067.pdf> for guidance to comply with ([Chapter 173-218 WAC](#)).

### Hydraulic Restriction Layers

Adjacent roads, foundations or other infrastructure may require that infiltration pathways are restricted to prevent excessive hydrologic loading. Two types of restricting layers can be incorporated into bioretention designs:

- Clay (bentonite) liners are low permeability liners. Where clay liners are used under-drain systems are necessary.
- Geomembrane liners completely block infiltration to subgrade soils and are used for groundwater protection when bioretention facilities are installed to filter storm flows from pollutant hotspots or on sidewalls of bioretention areas to restrict lateral flows to roadbeds or other sensitive infrastructure. Where geomembrane liners are used to line the entire facility under-drain systems are necessary. The liner should have a minimum thickness of 30 mils and be ultraviolet (UV) resistant.

### Plant Materials

In general, the predominant plant material utilized in bioretention areas are facultative species adapted to stresses associated with wet and dry conditions. Soil moisture conditions will vary within the facility from saturated (bottom of cell) to relatively dry (rim of cell). Accordingly, wetland plants may be used in the lower areas, if saturated soil conditions exist for appropriate periods, and drought-tolerant species planted on the perimeter of the facility or on mounded areas. The minimum requirements associated with the vegetation design include the following:

- The design plans must specify that vegetation coverage of selected plants will achieve 90% coverage within 2 years or additional plantings will be provided until this coverage is met.
- The plants must be sited according to sun, soil, wind, and moisture requirements of the plant.

- Plants shall have a maximum mature plant height of 3 feet to minimize the need for extensive pruning that could impact the function of the rain garden in future years.
- Select plants based on suitability for maintenance, including factors such as minimal pruning needs and minimal plant debris (e.g. fruits, bark).
- Minimize plantings around the inlet and outlet to maintain desired water flow.
- At a minimum, provisions must be made for supplemental irrigation during the first two growing seasons following installation.

Table 2.3 lists the plant species allowed for bioretention facilities in Clark County.

**Table 2.3: Plant List for Bioretention\***

<b>Moist to Wet Soil Conditions (Facility Bottom to Bottom of Overflow)</b> Table continues next page.				
Type	Botanical Name	Common Name	O.C. Spacing	Allowed ROW**
Herbaceous	<i>Carex densa</i>	Dense sedge	12”	Y
Herbaceous	<i>Carex morrowii</i>	Ice Dance	12”	Y
Herbaceous	<i>Carex obnupta</i>	Slough Sedge	12”	N
Herbaceous	<i>Deschampsia cespitosa</i>	Tufted Hair Grass	12”	N
Herbaceous	<i>Juncus patens</i>	Spreading Rush	12”	Y
Shrub	<i>Cornus sericea ‘Kelseyii’</i>	Kelsey Dogwood	24”	Y
Shrub	<i>Spiraea betulifolia</i>	Birchleaf Spiraea	24”	N
Shrub	<i>Spiraea densiflora</i>	Sub-alpine Spiraea	24”	Y
Shrub	<i>Spiraea japonica</i>	Japanese spirea cultivars	24”	Y
Groundcover	<i>Rubus calynoides &amp; pentalobus</i>	Creeping Bramble	12”	N
Accent	<i>Camassia leichtinii</i>	Great Camas	12”	N
Accent	<i>Camassia quamash</i>	Common Camas	12”	N
Tree	<i>Acer campestre ‘Evelyn’</i>	Elizabeth Hedge Maple	30’	Y
Tree	<i>Betula jacquemontii</i>	Jacquemontii Birch	60’	N

Tree	<i>Celtis occidentalis</i>	Hackberry	50'	N
Tree	<i>Koeleruteria paniculata</i>	Goldenrain Tree	30'	Y
Tree	<i>Nyssa sylvatica</i>	Black tupelo	50'	Y
Tree	<i>Prunus virginiana 'Canada Red'</i>	Canada Red Chokecherry	25'	Y
Tree	<i>Quercus shumardii</i>	Shumard Oak	70'	Y
Tree	<i>Rhamnus purshiana</i>	Cascara	30'	N
<b>Dry Soil Conditions (Overflow and Above)</b>				
<b>Type</b>	<b>Botanical Name</b>	<b>Common Name</b>	<b>O.C. Spacing</b>	<b>Allowed ROW</b>
Herbaceous	<i>Deschampsia cespitosa</i>	Tufted Hair Grass	12"	N
Herbaceous	<i>Helictotrichon sempervirens</i>	Blue Oat Grass	12"	Y
Shrub	<i>Cornus sericea 'Kelseyii'</i>	Kelsey Dogwood	24"	Y
Shrub	<i>Euonymus japonicas 'Microphyllus'</i>	Boxleaf Evergreen	24"	Y
Shrub	<i>Mahonia aquifolium 'Compacta'</i>	Oregon Grape	24"	Y
Shrub	<i>Spiraea betulifolia</i>	Birchleaf Spiraea	24"	N
Shrub	<i>Spiraea densiflora</i>	Sub-alpine Spiraea	24"	Y
Shrub	<i>Spiraea japonica</i>	Japanese spirea cultivars	24"	Y
Groundcover	<i>Arctostaphylos uva-ursi</i>	Kinnickinnick	12"	Y
Groundcover	<i>Fragaria chiloensis</i>	Coastal Strawberry	12"	Y
Groundcover	<i>Mahonia repens</i>	Creeping Oregon Grape	12"	N
Accent	<i>Camassia leichtinii</i>	Great Camas	12"	N
Accent	<i>Camassia quamash</i>	Common Camas	12"	N
Tree	<i>Acer campestre 'Evelyn'</i>	Elizabeth Hedge Maple	30'	Y

Tree	<i>Celtis occidentalis</i>	Hackberry	50'	N
Tree	<i>Koeleruteria paniculata</i>	Goldenrain Tree	30'	Y
Tree	<i>Prunus virginiana 'Canada Red'</i>	Canada Red Chokecherry	25'	Y
Tree	<i>Quercus shumardii</i>	Shumard Oak	70'	Y
Tree	<i>Rhamnus purshiana</i>	Cascara	30'	N
<p>Selected plants shall not include any plants from the State of Washington Noxious Weed List. Refer to <a href="http://www.clark.wa.gov/environmental-services/vegetation-management">www.clark.wa.gov/environmental-services/vegetation-management</a> for a current list of noxious weeds.</p> <p>*Adapted from Portland Bureau of Environmental Services 2014 <i>Stormwater Management Manual</i>, Appendix F.4., Planting Templates and Plant Lists</p> <p>** Plant species allowed in Clark County street Rights of Way</p>				

## Mulch layer

Bioretention areas can be designed with or without a mulch layer. When used, mulch shall be:

- Coarse compost in the bottom of the facilities (compost is less likely to float during cell inundation).
- Shredded or chipped hardwood or softwood on side slopes above ponding elevation and rim area. Arborist mulch is mostly woody trimmings from trees and shrubs and is a good source of mulch material. Wood chip operations are a good source for mulch material that has more control of size distribution and consistency. Do not use shredded construction wood debris or any shredded wood to which preservatives have been added.
- Free of weed seeds, soil, roots and other material that is not bole or branch wood and bark.
- A maximum of 2 to 3 inches thick.

Mulch shall **not** be:

- Grass clippings (decomposing grass clippings are a source of nitrogen and are not recommended for mulch in bioretention areas).
- Pure bark (bark is essentially sterile and inhibits plant establishment).

In bioretention areas where higher flow velocities are anticipated use an aggregate mulch to dissipate flow energy and protect underlying Bioretention Soil Mix. Aggregate mulch varies in size and type, but 1 to 1 1/2 inch gravel (rounded) decorative rock is typical.

## Runoff Modeling Representation

For projects that have to demonstrate compliance with Minimum Requirements #6 and/or #7, it is preferable to enter each bioretention device and its drainage area into the approved computer models for estimating their performance. However, where site layouts involve multiple bioretention facilities, the modeling schematic can become extremely complicated or not accommodated by the available schematic grid. In those cases, multiple bioretention facilities with similar designs (i.e., soil depth, ponding depth, freeboard height, and drainage area to ponding area ratio), and infiltration rates (Ecology suggests within a factor of 2) may have their drainage areas and ponded areas combined, and represented in the runoff model as one drainage area and one bioretention device. In this case, use a weighted average of the design infiltration rates at each location. The averages are weighted by the size of their drainage areas.

Each design infiltration rate is the measured infiltration rate ( $K_{sat}$ ) multiplied by the appropriate correction (reduction) factors. For these native soils below bioretention soils, a site variability correction factor,  $CF_v$ , should be considered.

## Construction Recommendations

Designers should include this information on their construction drawings to ensure the facilities are constructed properly.

### Excavation

Soil compaction can lead to facility failure; accordingly, minimizing compaction of the base and sidewalls of the bioretention area is critical. Excavation should never be allowed during wet or saturated conditions (compaction can reach depths of 2-3 feet during wet conditions and mitigation is likely not be possible). Excavation should be performed by machinery operating adjacent to the bioretention facility and no heavy equipment with narrow tracks, narrow tires, or large lugged, high pressure tires should be allowed on the bottom of the bioretention facility. If machinery must operate in the bioretention cell for excavation, use light weight, low ground-contact pressure equipment and rip the base at completion to refracture soil to a minimum of 12 inches. If machinery operates in the facility, subgrade infiltration rates must be field tested and compared to design rates. Failure to meet or exceed the design infiltration rate will require revised engineering designs to verify achievement of treatment and flow control benefits that were estimated in the Stormwater Site Plan.

Prior to placement of the BSM, the finished subgrade shall:

- Be scarified to a minimum depth of 3 inches.
- Have any sediment deposited from construction runoff removed. To remove all introduced sediment, subgrade soil should be removed to a depth of 3-6 inches and replaced with BSM.
- Be inspected by the responsible engineer to verify required subgrade condition.
- Sidewalls of the facility, beneath the surface of the BSM, can be vertical if soil stability is adequate. Exposed sidewalls of the completed bioretention area with BSM in place should be no steeper than 3H:1V. The bottom of the facility should be flat.

### **Soil Placement**

On-site soil mixing or placement shall not be performed if Bioretention Soil Mix or subgrade soil is saturated. The bioretention soil mixture should be placed and graded by machinery operating adjacent to the bioretention facility. If machinery must operate in the bioretention cell for soil placement, use light weight equipment with low ground-contact pressure. If machinery operates in the facility, subgrade infiltration rates must be field tested and compared to design rates. Failure to meet or exceed the design infiltration rate will require revised engineering designs to verify achievement of treatment and flow control benefits that were estimated in the Stormwater Site Plan.

The soil mixture shall be placed in horizontal layers not to exceed 6 inches per lift for the entire area of the bioretention facility. Compact the Bioretention Soil Mix to a relative compaction of 85 percent of modified maximum dry density (ASTM D 1557). Compaction can be achieved by boot packing (simply walking over all areas of each lift), and then apply 0.2 inches (0.5 cm) of water per 1 inch (2.5 cm) of Bioretention Soil Mix depth. Water for settling should be applied by spraying or sprinkling.

### **Temporary Erosion and Sediment Control (TESC)**

Controlling erosion and sediment are most difficult during clearing, grading, and construction; accordingly, minimizing site disturbance to the greatest extent practicable is the most effective sediment management.

During construction:

- Bioretention facilities should not be used as sediment control facilities and all drainage should be directed away from bioretention facilities after initial rough grading. Flow can be directed away from the facility with temporary diversion swales or other approved protection. If introduction of construction runoff cannot be avoided see below for guidelines.
- Construction on Bioretention facilities should not begin until all contributing drainage areas are stabilized according to erosion and sediment control BMPs and to the satisfaction of the engineer.

- If the design includes curb and gutter, the curb cuts and inlets should be blocked until Bioretention Soil Mix and mulch have been placed and planting completed (when possible), and dispersion pads are in place.

Every effort during design, construction sequencing and construction should be made to prevent sediment from entering bioretention facilities. However, bioretention areas are often distributed throughout the project area and can present unique challenges during construction. See the *LID*

*Technical Guidance Manual for Puget Sound* (2012) for guidelines if no other options exist and runoff during construction must be directed through the bioretention facilities.

Erosion and sediment control practices must be inspected and maintained on a regular basis.

### Verification

If using the standard bioretention soil media, pre-placement laboratory analysis for saturated hydraulic conductivity of the bioretention soil media is not required. Verification of the mineral aggregate gradation, compliance with the compost specifications, and the mix ratio must be provided.

If using a custom bioretention soil media, verification of compliance with the minimum design criteria cited above for such custom mixes must be included in the Stormwater Plan submittal per [Section 1.8 of Book 1](#). This will require laboratory testing of the material that will be used in the installation. Testing shall be performed by a Seal of Testing Assurance, AASHTO, ASTM or other standards organization accredited laboratory with current and maintained certification. Samples for testing must be supplied from the BSM that will be placed in the bioretention areas.

If testing infiltration rates is necessary for post-construction verification use a test method outlined in [Appendix 1-C](#). If using the PIT method, do not excavate Bioretention Soil Mix (conduct test at level of finished Bioretention Soil Mix elevation), use a maximum of 6 inch ponding depth and conduct test before plants are installed.

## BMP T5.15: Permeable Pavements

---

### Purpose and Description

Permeable pavements are appropriate in many applications where traditionally impermeable pavements have been used including parking lots, sidewalks, pedestrian and bike trails, driveways, residential access roads, and emergency and facility maintenance roads.

The following are the general categories of permeable paving systems:

- Porous hot or warm-mix asphalt pavement: A flexible pavement similar to standard asphalt, but the fine material is reduced or eliminated, allowing water to infiltrate through voids formed between the aggregate in the pavement surface.
- Pervious Portland cement concrete: A rigid pavement similar to conventional concrete but with the fine aggregate (sand) component reduced or eliminated in the gradation, allowing for infiltration.
- Permeable interlocking concrete pavements (PICP) and aggregate pavers: Solid, precast, manufactured modular units. The solid pavers are (impervious) high-strength Portland cement concrete. Pavements constructed with these units create joints that are filled with permeable aggregates and installed on an open-graded aggregate bedding course. Aggregate pavers (also known as pervious pavers) are distinct from PICPs and include modular precast paving units. The units are made with similar sized aggregates bound together with Portland cement concrete with high-strength epoxy or other adhesives. Like PICP, the joints or openings in the units are filled with open-graded aggregate and placed on an open-graded aggregate bedding course. Aggregate pavers are intended for pedestrian use only.
- Grid systems: Made of concrete or plastic. Both systems can be installed on an open-graded aggregate base as well as a dense-graded aggregate base.

### Cross Reference Guide

Soils Assessment	<a href="#">Book 1, Section 2.3</a>
Meets Minimum Requirements	#5
Related BMPs	None
Selection Criteria	<a href="#">Book 1, Sections 2.2 and 2.5.5</a>
Maintenance	<a href="#">Book 4</a>



## Applications, Limitations and Setbacks

Permeable paving surfaces are an important integrated management practice within the LID approach and can be designed to accommodate pedestrian, bicycle and auto traffic while allowing infiltration, treatment and storage of stormwater. [Table 2.4](#) shows typical applications for the different types of permeable pavement.

### Limitations

- The Washington State Pollution Control Hearings Board stated in 2014 that permeable pavement is only suitable for “roadways that receive very low traffic volumes and areas of very low truck traffic”. This has been interpreted to mean that it’s only required to be considered (i.e. review infeasibility criteria) for roadways with an average daily volume of 400 vehicles or less. See [Section 2.5.5.3 in Book 2-1](#) for a full list of infeasibility criteria, and refer to [Table 2.4](#) for typical applications of pervious pavements.
- ~~No run-on from pervious surfaces is allowed.~~ ←
- Unless the pavement, base course, and subgrade have been designed to accept runoff from adjacent impervious surfaces, slope impervious runoff away from the permeable pavement to the maximum extent practicable. Sheet flow from up-gradient impervious areas is not recommended, but permissible if the porous surface flow path is greater than the impervious surface flow path.

Run-on from pervious surfaces is not allowed, except from minor or incidental pervious areas that cannot be directed elsewhere. Those areas must be fully stabilized before discharging runoff to the pervious pavement.

### Setbacks

The following setbacks are required for permeable pavements:

- 50 feet from the top of slopes greater than 20% with more than 10 feet of vertical relief.
- 100 feet from a landfill (active or closed).
- 100 feet from a drinking water well or a spring used for drinking water, if the pavement is a pollution-generating surface.
- 10 feet from on-site sewage drainage.
- 10 feet from an underground storage tank and its connecting pipes that is used to store petroleum products, chemicals, or liquid hazardous waste in which 10% or more of the storage volume of the tank and connecting pipes is beneath the ground.
- 100 feet from an area with known deep soil contamination.

**Table 2.4: Typical Applications for Types of Permeable Pavements**

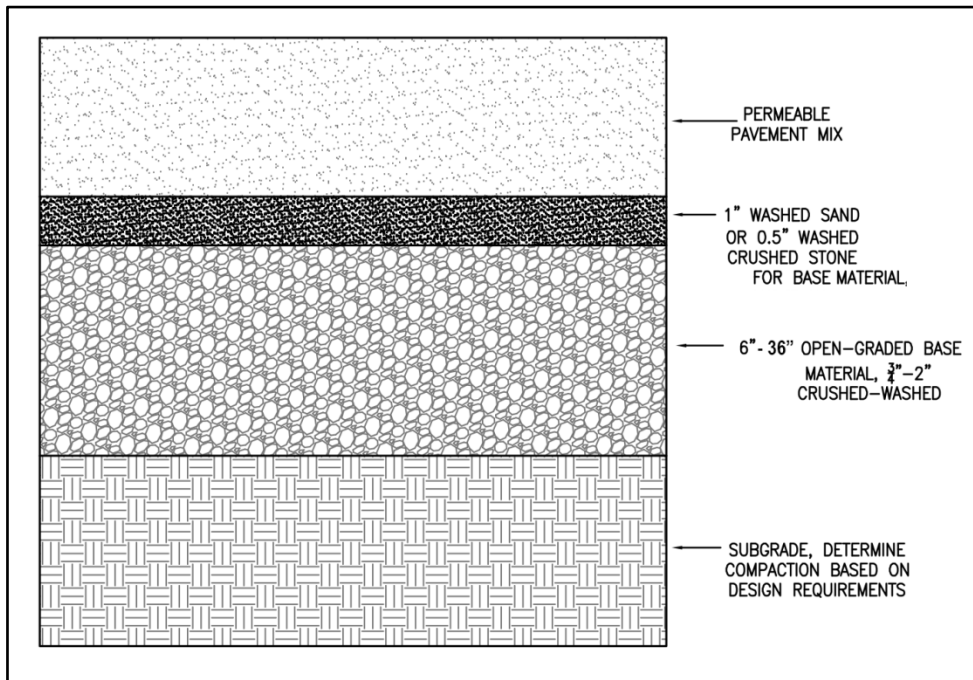
Permeable Pavement Category	Residential walk/patio	Residential driveway	Commercial pedestrian plaza	Emergency access lane or overflow parking lot	Parking lot or travel lanes	Residential street with ADT of 400 or less	Residential >400 ADT, collector or High speed highway (>35 mpg)
Porous Asphalt	Yes	Yes	Yes	Yes	Yes	Yes	No
Pervious Concrete	Yes	Yes	Yes	Yes	Yes	Yes	No
PICP	Yes	Yes	Yes	Yes	Yes	Yes	No
Grid	Yes	Yes	Yes	Yes	No	No	No

(Source: LID Technical Guidance Manual for Puget Sound amended)



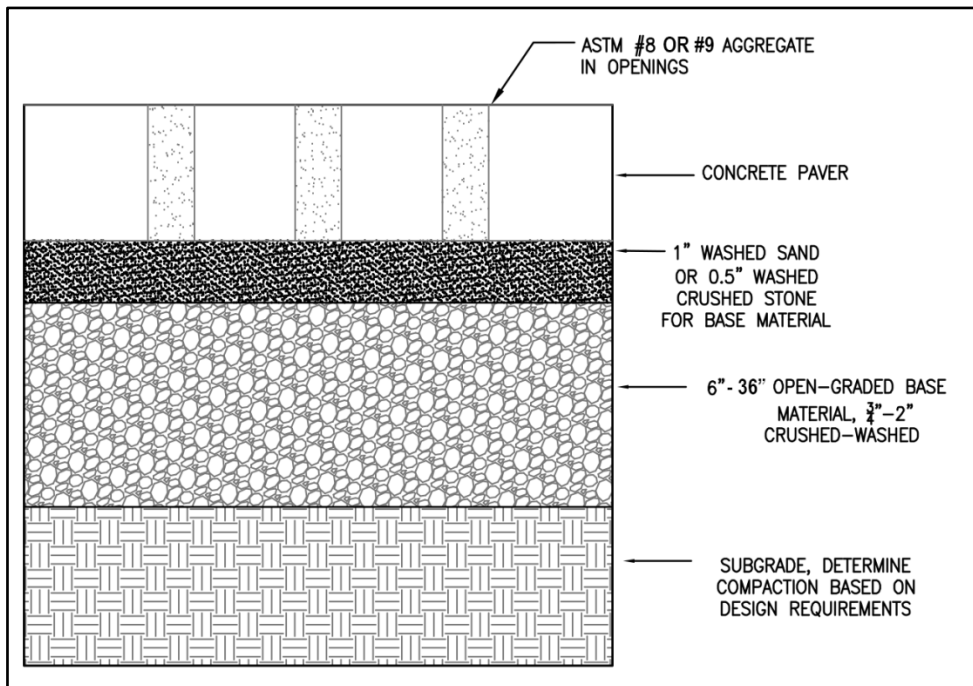
**Figure 2.19: Permeable Pavement Application**

(Source: McCord's Vancouver Toyota)



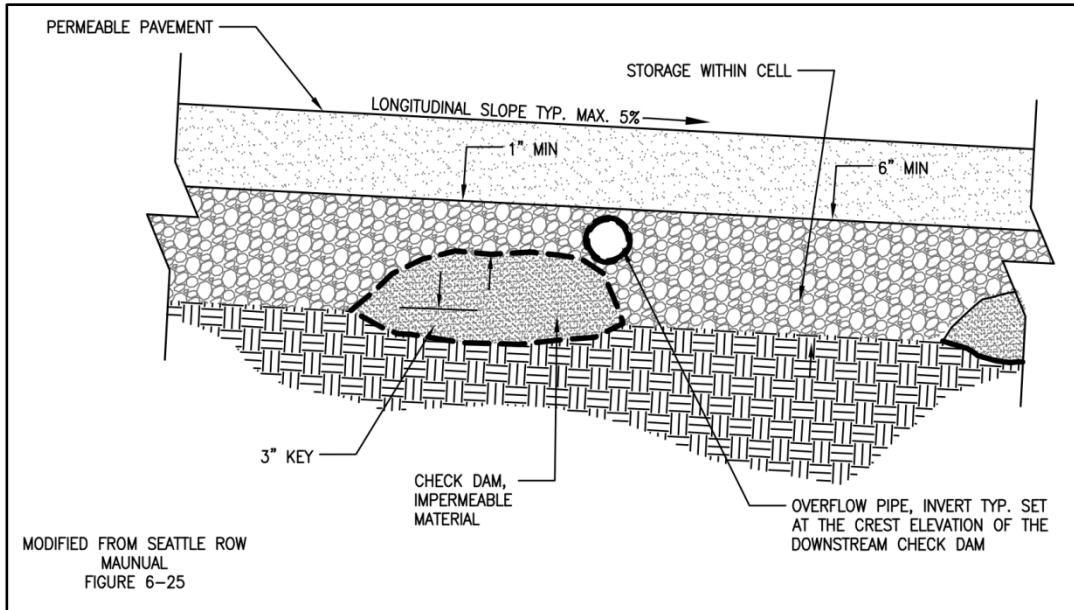
**Figure 2.20: Permeable Pavement Typical Section**

(Source: redrawn from City of Portland)



**Figure 2.21: Permeable Pavement Typical Section of Pavers**

(Source: redrawn from City of Portland)



**Figure 2.22: Permeable Pavement Check Dam for Sloped Pavement**

(Source: modified from SMMWW)

*Refer to the [LID Technical Guidance Manual](#) (Puget Sound Partnership, 2012) for additional information on permeable pavements. Note that where information in the guidance manual conflicts with information in this manual, the information in this manual must be used.*

## Design Criteria

### Estimation of Long-Term Infiltration Rates

- The infiltration rate shall be determined using the testing procedures described in [Book 1, Section 2.3.1.4](#), with an additional correction factor ranging from 0.9 to 1.0 based on the quality of the aggregate base material.

### Contributing Area

- Minimizing the contributing area is preferable since run-on from adjacent surfaces can lead to clogging and reduce long-term performance of permeable pavements. Some stormwater discharge from other surfaces is acceptable if:
  - Sediment is not introduced to the subgrade or pavement surface.
  - The additional flow does not exceed the long-term infiltration capacity of the subgrade or pavement surface.

### Subgrade

- The subgrade should be compacted to the minimum extent necessary for structural stability, including the following recommendations:

- On sites where topsoil is removed and native sub-soil is exposed, no compaction may be required.
- For areas with heavy truck traffic, some compaction may be necessary for stability.
- Guidelines used to specify subgrade compaction are “firm and unyielding” (qualitative), and 90- 92% Standard Proctor (quantitative).
- Prevent compaction when installing the aggregate base by:
  - Dumping the aggregate base onto the subgrade from the edge of the installation and then push the aggregate out onto the subgrade.
  - Dumping subsequent loads from on top of the aggregate base as the installation progresses.
- Relative uniformity of subgrade conditions is important to prevent differential settling.

### Separation or Bottom Filter Layer (Recommended but Optional)

- A 0.5 inch (or smaller) layer of sand or crushed stone graded allows for infiltration across the surface, stabilization of the base layer and protection of underlying soil from compaction. This layer can also serve as a transition between the base course and the underlying geotextile material.

### Wearing Layer

- A minimum initial infiltration rate of 20 inches per hour is necessary. To improve the probability of long-term performance, significantly higher initial infiltration rates are desirable.
- Porous Asphalt: Must have adequate void spaces for infiltration. A void space within the range of 16 – 25% is typical.
- Pervious Concrete: A void space within the range of 15 – 35% is typical
- Grid/lattice systems filled with gravel, sand, or a soil of finer particles with or without grass: The fill material must be at least a minimum of 2 inches of sand, gravel, or soil.
- Permeable Interlocking Concrete Pavement and Aggregate Pavers: Pavement joints should be filled with No. 8 or 9 stone. z

### Geotextiles

- For all permeable pavement systems, geotextile material must line the sides of open graded base perimeters to prevent soil intrusion if concrete curbs or other types of impermeable liners do not extend to the full depth of the base material. The geotextile material should follow the manufacturer’s specifications and recommendations of the project geotechnical engineer for the particular subgrade soil and aggregate base being used.
- Geotextiles are not allowed between the permeable pavement system and subgrade because of their tendency to clog.

- Geogrids can also be used for subgrade reinforcement at the recommendation of a geotechnical engineer.

### Membrane Liners and Barriers

- Membrane liners and barriers are recommended to reduce sidewall soil movement and reduction of infiltration capacity, and to protect adjacent, densely-graded subgrade material from migrating onto the aggregate base. 30 mil PVC membranes are generally used.

### Storage Reservoir/Aggregate Base

- The aggregate base material should be composed of larger material (1.5-2.5 inches).
- Smaller stone may be used between the larger stones.
- Void space should be 20-40%.
- Aggregate base depth should be 6-36 inches, depending on pavement type, design and storage requirements.

### Drainage conveyance

Roads should still be designed with adequate drainage conveyance facilities as if the road surface was impermeable. Roads with base courses that extend below the surrounding grade should have a designed drainage flow path to safely move water away from the road prism and into the roadside drainage facilities. Use of perforated storm drains to collect and transport infiltrated water from under the road surface will result in less effective designs and less flow reduction benefit.

### Underdrain (Optional)

Note that if an underdrain is placed at or near the bottom of the aggregate base in a permeable pavement design, the permeable pavement is no longer considered an LID BMP and cannot be used to satisfy Minimum Requirement #5. However, a design using an underdrain that is elevated within the aggregate base course to protect the pavement wearing course from saturation is considered an LID BMP and can be used to satisfy Minimum Requirement #5. See [Appendix 2-C](#) and the WWHM User’s Manual for guidance in modeling permeable pavements with underdrains.

### Permeable interlocking concrete pavements (PICP) Seed Mix

Seed mix within the grids for PCIP shall be as follows:

**Table 2.5: PCIP Seed Mix**

Botanical Name	Common Name	% By Weight
<i>Festuca rubra</i> ‘Chewings’	Chewings fescue	25.00%
<i>Lolium perenne</i>	perennial rye grass	75.00%

TOTAL		100.00%
-------	--	---------

### Runoff Modeling Representation

- In the runoff modeling, similar designs throughout a development can be summed and represented as one large facility. For instance, walkways can be summed into one facility. Driveways with similar designs (and enforced through deed restrictions) can be summed into one facility. In these instances, a weighted average of the design infiltration rates (where within a factor of two) for each location may be used. The averages are weighted by the size of their drainage area. The design infiltration rate for each site is the measured Ksat multiplied by the appropriate correction factors.
- As an alternative, simply enter walks, patios, and driveways with little storage capacity in the gravel bedding beneath them as lawn/landscape areas in the continuous flow model. Roads and parking lots that have storage in a base course below the wearing surface should use the permeable pavement element in the continuous flow model.
- See [Appendix 2-C](#) for additional runoff modeling guidance.

### Quality Control and Acceptance testing

- County to inspect subgrade prior to installation of base material
- Driveways can be tested by simply throwing a bucket of water on the surface. If anything other than a scant amount puddles or runs off the surface, additional testing is necessary prior to accepting the construction.
- Roads may be initially tested with the bucket test. In addition, test the initial infiltration with a 6-inch ring, sealed at the base to the road surface, or with a sprinkler infiltrometer. Wet the road surface continuously for 10 minutes. Begin test to determine compliance with 20 inches per hour minimum rate. Use of ASTM C1701 is also recommended.

## BMP T5.16: Tree Retention and Tree Planting

---

### Purpose and Description

Trees provide stormwater flow control through interception, transpiration, and increased infiltration. Additional environmental benefits include improved air quality, carbon sequestration, reduced heat island effect, pollutant removal, and habitat preservation or creation.

The degree of flow control achieved depends on the tree type (i.e., evergreen or deciduous), canopy area, and whether or not the tree canopy overhangs impervious surfaces. Flow control credits may be applied to project sites of all sizes. The photograph below shows an example of tree retention for stormwater control in an urban setting.

When implemented in accordance with the criteria outlined below, retained and newly planted trees receive credits toward meeting flow control requirements.



**Figure 2.23: Trees preserved and planted in a development**

(Source: Clark County)



## Cross Reference Guide

Soils Assessment	None
Meets Minimum Requirements	#5
Related BMPs	None
Selection/Infeasibility Criteria	See below
Maintenance	None

## Design Criteria

### Retained Trees

- Existing tree species and location must be clearly shown on submittal drawings.
- Trees must be viable for long-term retention (i.e., in good health and compatible with proposed construction).
- Tree size: To receive flow control credit, retained trees require a minimum diameter at breast height (DBH) of 6 inches.
  - DBH is defined as the outside bark diameter at 4.5 feet above the ground on the uphill side of a tree.
  - For existing trees smaller than 6 inches at DBH, the newly planted tree credit may be applied.
- The retained tree canopy area must be measured as the area within the tree drip line.
  - A drip line is the line encircling the base of a tree, which is delineated by a vertical line extending from the outer limit of a tree's branch tips down to the ground. Overlapping canopies are not double counted.
- An arborist report may be required if impervious surface is proposed within the critical root zone of the existing tree.
  - If the arborist report determines that impervious surface should not be placed within 20 feet of the tree and canopy overlap with impervious surface is still anticipated given a longer setback, the higher tree flow control credit may be approved.
- The existing tree roots, trunk, and canopy must be fenced and protected during construction.
- Trees must be retained, maintained and protected on the site for the life of the development or until any approved redevelopment occurs in the future.

- Trees that are removed or die shall be replaced with like species during the next planting season (typically in fall).
- Trees shall be pruned according to industry standards (ANSI A 300 standards).
- Do not pave or restrict within the projected area of the mature trunk's flare (the transition area between root and crown, often 2-3 times the trunk diameter measured 4 feet from the ground).
- Use permeable pavement for hard surfaces around the tree, to allow gas exchange and to increase soil moisture.
- Protect the tree and tree pit soil from surrounding uses such as pedestrians and vehicles.

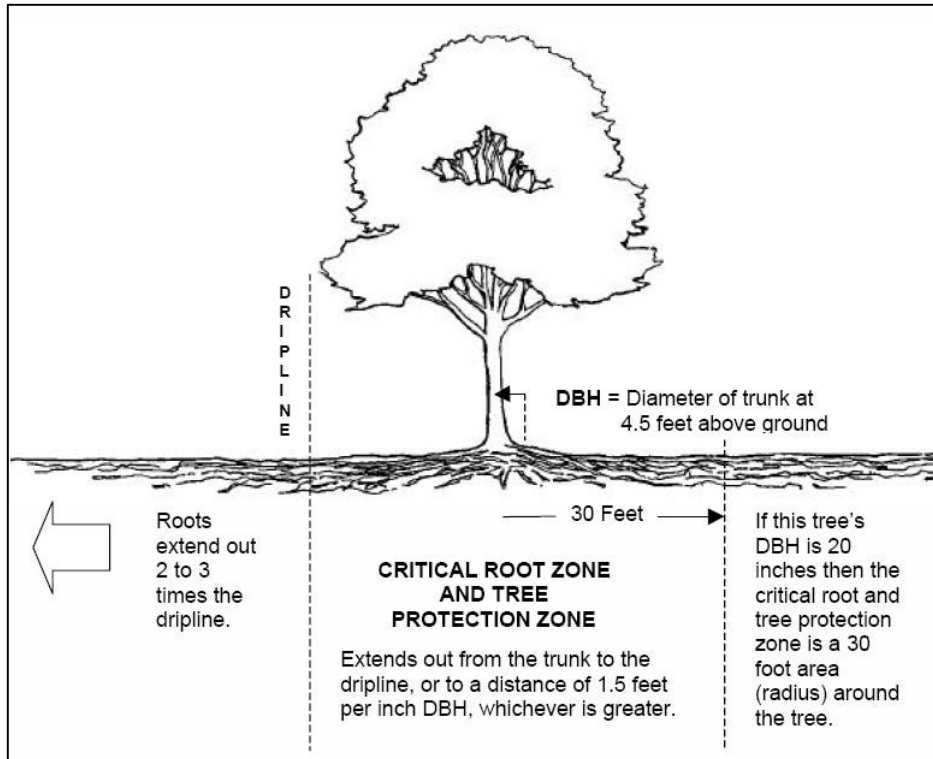
### Newly Planted Trees

- All tree plantings shall comply with other applicable Clark County Code as stated in Title 40.
- To receive flow control credit, new deciduous trees at the time of planting must have a diameter of at least 1.5 inches measured 6 inches from the ground. New evergreen trees must be at least 4 feet tall.
- Trees should be sited according to sun, soil, and moisture requirements.
  - Planting locations shall be selected to ensure that sight distances and appropriate setbacks are maintained given mature height, size, and rooting depths.
  - Similar to retained trees, flow control credit for newly planted trees depends upon proximity to ground level impervious surfaces.
  - To receive a credit, the tree must be planted on the development site and within 20 feet of new and/or replaced ground level impervious surfaces (e.g., driveway, patio, or parking lot).
    - Distance from impervious surfaces is measured from the edge of the surface to the center of the tree at ground level.
  - Minimum tree spacing shall accommodate mature tree spread. Flow control credit is not given for new tree density exceeding 10 feet on center spacing.
  - Trees shall be retained, maintained and protected on the site after construction and for the life of the development as required for retained trees.

### Planting Guidelines

- Provisions shall be made for supplemental irrigation during the first three growing seasons after installation to help ensure tree survival.
- Do not pave or restrict within the estimated projected area of the mature trunk's flare (the transition area between root and crown, often 2-3 times the trunk diameter measured 4 feet from the ground).
- Use permeable pavement for hard surfaces around the tree, to allow gas exchange and to increase soil moisture.

- Protect the tree and tree pit soil from surrounding uses such as pedestrians and vehicles.
- Trees must be staked on two sides for a minimum of one year to ensure root stability during the establishment period. Stakes should be loose such that they do not interfere with the free movement of the tree and should be 2/3 the height of the tree.



**Figure 2.24: Illustration of Tree Retention and Tree Planting Concepts**

(Source: Athens/Clark County, Georgia)

## Runoff Modeling Representation

Flow control credits for retained trees are provided in [Table 2.6](#) by tree type. These credits can be applied to reduce impervious or other hard surface area requiring flow control. Credits are given as a percentage of the existing tree canopy area. The minimum credit for existing trees ranges from 50 to 100 square feet.

**Table 2.6: Tree Credits – Retained Trees**

Tree Type	Credit
Evergreen	20% of canopy area (minimum of 100 square feet per tree)
Deciduous	10% of canopy area (minimum of 50 square feet per tree)

Impervious/Hard Surface Area Mitigated =  
 $(\sum \text{Evergreen Canopy Area} \times .2) + (\sum \text{Deciduous Canopy Area} \times 0.1)$

Tree credits are not applicable to trees in native vegetation areas used for flow dispersion or other flow control credit. Credits are also not applicable to trees in planter boxes. The total tree credit for retained and newly planted trees shall not exceed 25 percent of impervious or other hard surface requiring mitigation.

Flow control credit for retained trees depends upon proximity to ground level impervious or other hard surfaces. To receive a credit, the existing tree must be on the development site and within 20 feet of new and/or replaced ground level impervious or other hard surfaces (e.g., driveway or patio) on the development site. Distance from impervious or other hard surfaces is measured from the tree trunk center.

**Newly Planted Trees**

Flow control credits for newly planted trees are provided in [Table 2.6](#) by tree type. These credits can be applied to reduce the impervious or other hard surface area requiring flow control. Credits range from 20 to 50 square feet per tree.

**Table 2.7: Tree Credits – Newly Planted Trees**

Tree Type	Credit
Evergreen	50 square feet per tree
Deciduous	20 square feet per tree

Impervious/Hard Surface Area Mitigated =  $\sum \text{Number of Trees} \times \text{Credit (sq. ft.)}$

Tree credits are not applicable to trees in native vegetation areas used for flow dispersion or other flow control credit. Credits are also not applicable to trees in planter boxes. The total tree credit for retained and newly planted trees shall not exceed 25 percent of impervious or other hard surface requiring mitigation.

## BMP T5.17: Vegetated Roofs

---

### Purpose and Description

Vegetated roofs (also known as ecoroofs and green roofs) are thin layers of engineered soil and vegetation constructed on top of conventional flat or sloped roofs. Vegetated roofs can provide stormwater volume reduction and flow attenuation. The range of benefits for a green roof depends on a number of design factors such as plant selection, depth and composition of soil mix, location of the roof, orientation and slope, weather patterns, and the maintenance plan. The photograph below shows an example vegetated roof application.



**Figure 2.25: Example Vegetated Roof in Philadelphia**

(Source: EPA Office of Water, Publication EPA-841-B-00-005D)

## Cross Reference Guide

Soils Assessment	None
Minimum Requirements	MR #5
Related BMPs	None
Selection/Infeasibility Criteria	See below
Maintenance	None

## Applications, Limitations and Setbacks

While vegetated roofs can be installed on slopes up to 40 degrees, slopes between 5 and 20 degrees (1:12 and 5:12) are most suitable and can provide natural drainage by gravity. Roofs with slopes greater than 10 degrees (2:12) require an analysis of engineered slope stability.

All vegetated roofs consist of four basic components: a waterproof membrane, a drainage layer, a light-weight growth medium, and vegetation. In addition to these basic components, many systems may also incorporate a protection layer and root barrier to preserve the integrity of the waterproof membrane, a separation/filter layer to stabilize fine particles, capillary mats and mulch/mats to retain moisture and prevent surface erosion due to rain and wind scour.

## Design Criteria

For green roof design, follow the International Green Construction Code (IgCC) for all design considerations. Note that specific information can be found in section 403 for stormwater and 408 for vegetative roofs. The IgCC follow the International Code Council recommendations for building codes (as adopted by the State of Washington).

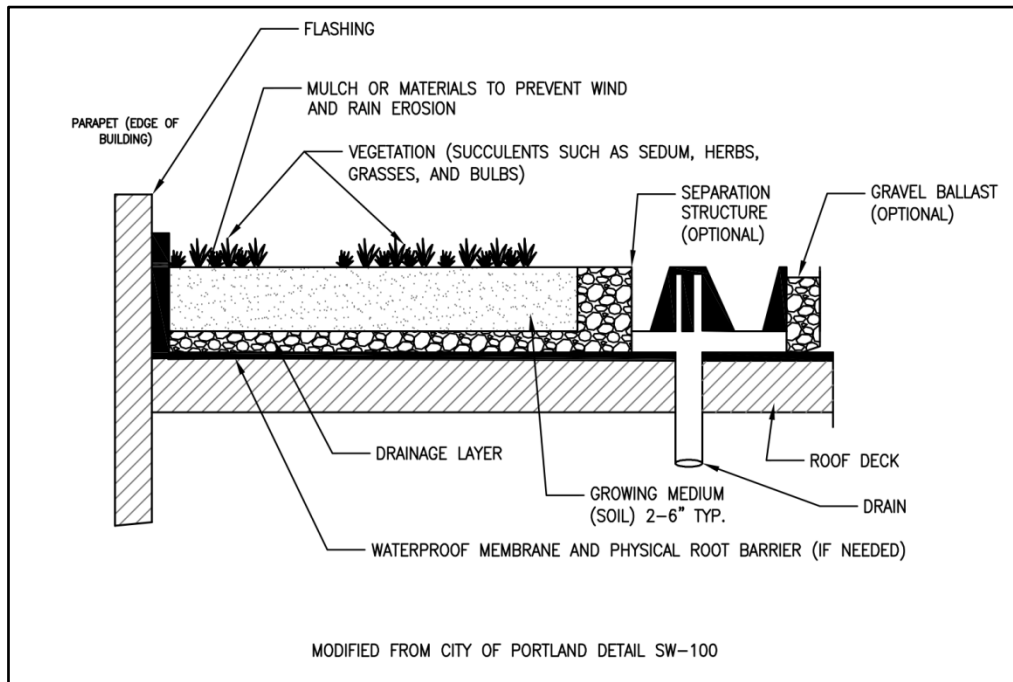
<https://fortress.wa.gov/ga/apps/sbcc/page.aspx?nid=4>

The *LID Technical Guidance Manual for Puget Sound* (The Puget Sound Partnership, 2012) includes a more detailed description of the components of and design criteria for vegetated roofs. It also includes references to other sources of information and design guidance.

There are a number manufacturers and components to design and build a vegetated roof. Along with using the IgCC as guidance the designer should consult manufacturers' Design Criteria.

## Safety

All roof systems should provide for maintenance/user safety, include the use of railings where fall requirements are needed per the applicable building codes.



**Figure 2.26: Vegetated Roof Typical Section**

(Source: City of Portland)

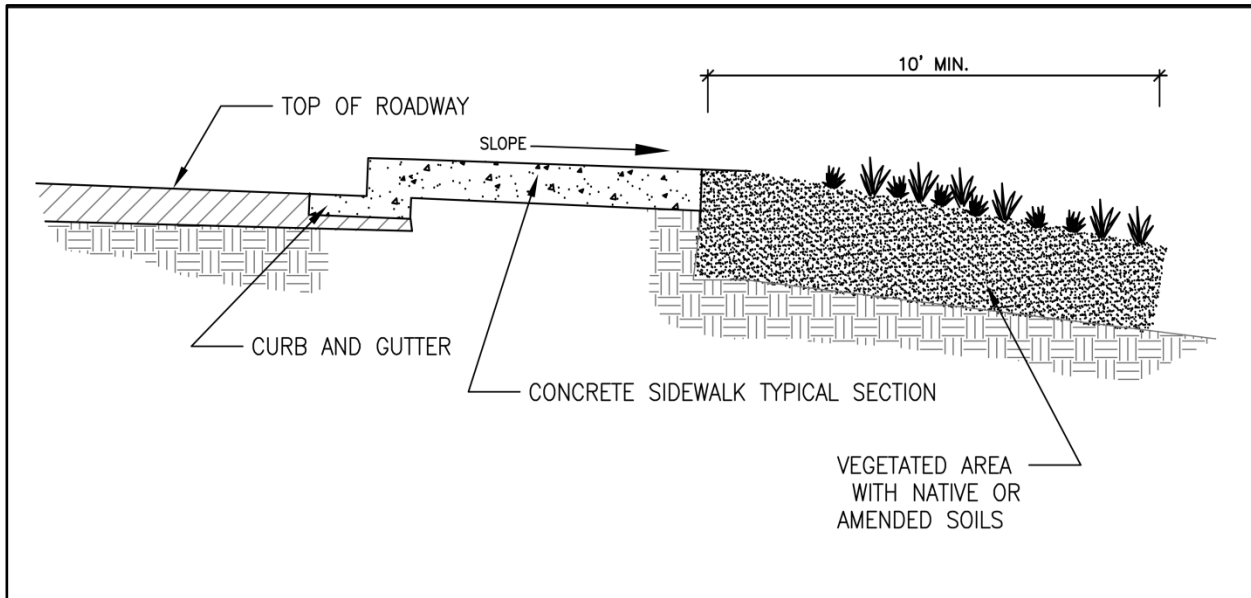
### Runoff Modeling Representation

- Option 1: For 3 inches to 8 inches of soil growing media use 50% SG3 or till as allowed by the approved continuous flow model landscaped area; 50% impervious area
- Option 2: For  $\geq 8$  inches of soil/growing media use 50% SG3 or till as allowed by the approved continuous flow model pasture; 50% impervious area
- See [Appendix 2-C](#) for additional guidance of how vegetated roofs may be entered into the approved continuous flow models.

## BMP T5.18: Reverse Slope Sidewalks

### Purpose and Description

Reverse slope sidewalks are sloped to drain away from the road and onto adjacent vegetated areas.



**Figure 2.27: Reverse Slope Sidewalk Schematic.**

(Source: redrawn from City of Bellevue 2013 Surface Water Engineering Standard Details)

### Cross Reference Guide

Soils Assessment	None
Minimum Requirements	MR #5
Related BMPs	<a href="#">BMP T5.13</a>
Selection/Infeasibility Criteria	See below
Maintenance	None

### Applications, Limitations and Setbacks

This BMP is applicable anywhere a proper vegetated flow path can be provided.



### Design Criteria

- There must be at least 10 feet of vegetated flow path downslope of the BMP that is not directly connected into the storm drainage system.
- Vegetated area receiving flow from sidewalk shall be native soil or meet soil quality guidelines from [BMP T5.13: Post-Construction Soil Quality and Depth](#).
- With the exception of slope direction the sidewalk to be installed consistent with County Road Standards.

### Runoff Modeling Representation

- In WWHM3, enter sidewalk area as lawn/landscaped area over the underlying soil type. For WWHM 2012, see [Appendix 2-C](#).

## BMP T5.19: Minimal Excavation Foundations

---

### Purpose and Description

Low impact foundations are defined as those techniques that do not disturb, or minimally disturb the natural soil profile within the footprint of the structure. This preserves most of the hydrologic properties of the native soil. Minimal excavation foundations are typically a combination of driven piles and a connecting component. The foundations are designed to engage deeper load-bearing soils without disrupting upper soil layers (which provide stormwater benefits including infiltration, storage and filtration). Minimal Excavation Foundations can be used for residential or commercial structures no more than three stories high. This technology is especially useful for elevated paths and footbridges in open space areas and other areas of elevated environmental sensitivity. The photograph below show an example pin pier foundation and the completed project.



**Figure 2.28: Pin Pier Foundation Construction & Completed Project, Bainbridge Island**

(Source: LID Technical Guidance Manual for Puget Sound)

## Cross Reference Guide

Soils Assessment	None
Minimum Requirements	MR #5
Related BMPs	None
Selection/Infeasibility Criteria	See below
Maintenance	None

## Applications, Limitations and Setbacks

To minimize soil compaction, heavy equipment cannot be used within or immediately surrounding the building. Terracing of the foundation area may be accomplished by tracked, blading equipment not exceeding 650 psf.

## Design Criteria

### Pier Applications

- Grubbing and (sometimes) blading is needed to prepare the site.
- The lightest possible tracked equipment should be used for grading, to prevent reduction of the permeability of the soil.
- On flat sites, blading should be done only to shape the site for optimal infiltration.
- On sloped sites, blading can be used to smooth the soils at their existing grade, again for optimal infiltration.

### Wall Applications

- Sloped sites should be terraced to receive flat-bottomed forms or pre-cast walls.
- A free-draining buffer material, such as pea gravel, corrugated vinyl or foam, should be placed on the surface soils to prepare the location for the wall components.
- Separate the base of the grade beam from the soil surface to prevent impacts of expansion or frost heave, and in some cases allows movement of saturated flow under the wall.

### Dispersing Roof Stormwater with Minimal Excavation Foundations

- If possible, roof runoff should be infiltrated upstream of the structure and across the broadest area manageable.

- Garage slabs, monolithic poured patios or driveways can block dispersed flows from the foundation perimeter. Dispersing roof runoff uphill of these areas is not recommended.
- Some soils or other site conditions may not warrant intentional direction of subsurface flows to directly beneath the structure. In these cases, only the preserved soils surrounding the structure may be relied on to mimic natural flows.

## Runoff Modeling Representation

- Where residential roof runoff is dispersed on the up gradient side of a structure in accordance with the design criteria and guidelines in [BMP T5.10B](#), the tributary roof area may be modeled as pasture on the native soil.
- In “step forming”, the building area is terraced in cuts of limited depth. This results in a series of level plateaus on which to erect the form boards. Where “step forming” is used on a slope, the square footage of roof that can be modeled as pasture must be reduced to account for lost soils. The following equation (suggested by Rick Gagliano of Pin Foundations, Inc.) can be used to reduce the roof area that can be modeled as pasture.

$$A1 - \frac{dC(0.5)(A1)}{dP} = A2$$

Where:

- A1 = roof area draining to up gradient side of structure
  - dC = depth of cuts into the soil profile
  - dP = permeable depth of soil (The A horizon plus an additional few inches of the B horizon where roots permeate into ample pore space of soil).
  - A2 = roof area that can be modeled as pasture on the native soil
- If roof runoff is dispersed down gradient of the structure in accordance with the design criteria and guidelines in [BMP T5.10B](#), AND there is at least 50 feet of vegetated flow path through native material or lawn/landscape area that meets the guidelines in [BMP T5.13](#), the tributary roof areas may be modeled as lawn/landscaped area.

## BMP T5.20: Rainwater Harvesting

### Purpose and Description

Rainwater harvesting is the capture and storage of rainwater for beneficial use. Roof runoff may be routed to cisterns for storage or non-potable usage. Rainwater harvesting can help reduce peak stormwater flows, durations, and volumes. Rainwater collection can also reduce water distribution costs through collection close to the end use. Note that rainwater can be used for irrigation and can be dispersed to landscaped areas during dry weather in the wet season.

*Ecology has issued a policy interpretation clarifying that a water right is not required for rooftop rainwater harvesting. More information can be found at: <http://www.ecy.wa.gov/programs/wr/hq/rwh.html>*



**Figure 2.29: Cistern for Rainwater Harvesting**

(Source: McCord’s Toyota, Vancouver, WA)

### Cross Reference Guide

Soils Assessment	None
Minimum Requirements	MR #5
Related BMPs	None
Selection/Infeasibility Criteria	See below
Maintenance	None

## Applications, Limitations and Setbacks

Restrict use to 4 homes/acre housing and lower densities when the captured water is solely for outdoor use.

## Design Criteria

Reference Chapter 16 of the 2012 Uniform Plumbing Code adopted by the State of Washington effective on July 1, 2013 for design guidance for rainwater harvesting systems.

- 100% reuse of the annual average runoff volume (based on calculations from a continuous flow model).
- System designs involving interior uses must have a monthly water balance that demonstrates adequate capacity for each month and reuse of all stored water annually.

## Roof Area

- National Sanitation Foundation certified appropriate products.

## Gutters and Downspouts

- Aluminum, galvanized steel, or plastic.

## First Flush Diverters

- Because first flush can contain high contaminant levels, collect and route first flush away from collection system.
  - The *Texas Guide to Rainwater Harvesting* recommends first 10 gallons for every 1,000 square feet of roof.

## Roof Washers

- Place just before cistern to filter debris.
- 30-50 gallon tank.
- Coarse filter/strainer for leaves and other organics.
- Finer filter ( $\leq 30$  microns).
- Clean regularly.

## Storage Tank or Cistern

- Fiberglass, polyethylene, concrete, metal, or wood.
- Above ground or underground tank.

### Pumps and Pressure Tanks

- Must be able to deliver water from the storage tank to the water treatment facility at adequate pressures (40-60 psi for residences), which is often not possible via elevation alone.
- Two methods are used:
  - A pump with a pressure tank, pressure switch and check valve.
    - Tank keeps system pressurized, switch initiates the pump when pressures fall below a prescribed level and check valve prevents higher pressure water from returning to the tank.
  - On-demand pump.

### Back Flow Prevention

- A back flow device is required to prevent contamination of potable water supply for areas where rainwater is used to augment potable supply for non-potable uses. Check with the Building Official for requirements.

### Water Treatment

- Filtration
- Disinfection (UV, Ozone, Activated Carbon or Chlorine)
- Buffering

### Runoff Modeling Representation

- Do not enter drainage area in runoff model.

## BMP T5.30A: Full Dispersion

---

### Purpose and Description

This BMP allows for "fully dispersing" runoff from impervious surfaces and cleared areas of development sites that protect at least 65% of the site (or a threshold discharge area on the site) in a forest or native condition.

### Cross Reference Guide

Soils Assessment	None
Minimum Requirements	MR #5
Related BMPs	<a href="#">BMP T5.13</a>
Selection/Infeasibility Criteria	<a href="#">Book 1, Section 2.5.3</a>
Maintenance	None

### Applications, Limitations and Setbacks

- [BMP T5.30A](#) Full Dispersion is used in the following situations:
- Rural single family residential developments should use these dispersion BMPs wherever possible to minimize effective impervious surface to less than 10% of the development site.
- Other types of development that retain 65% of the site (or a threshold discharge area on the site) in a forested or native condition may also use these BMPs to avoid triggering the flow control facility requirement.
- The preserved area may be a previously cleared area that has been replanted in accordance with native vegetation landscape specifications described within this BMP.

### Setbacks

Because Full Dispersion relies on the dispersion devices and design criteria for various dispersion BMPs, setbacks for each type of dispersion BMP used to achieve full dispersion shall be observed.

### Design Criteria

Developments that preserve 65% of a site (or a threshold discharge area of a site) in a forested or native condition can disperse runoff from the developed portion of the site into the native vegetation area as long as the developed areas draining to the native vegetation do not have impervious areas that exceed 10% of the entire site.



Where a development has less than 65% of a site available to maintain or create into a forested or native condition, that area may still be used for full dispersion of a portion of the developed area. The ratio of the native vegetation area to the impervious area, which is dispersed into the native vegetation, must not be less than 65 to 10. The lawn and landscaping areas associated with the impervious areas may also be dispersed into the native vegetation area. The lawn and landscaped area must comply with [BMP T5.13](#).

All design requirements listed also must be met:

- The preserved area should be selected in order to limit the clearing of existing forest cover, to maximize preservation of wetlands, and to buffer stream corridors.
- Wetland areas as well as streams and lakes do not count toward the 65% forest or native condition area.
- The preserved area should be placed in a separate tract or protected through recorded easements for individual lots.
- The preserved area should be shown on all property maps and should be clearly marked during clearing and construction on the site.
- The preserved area may be used for passive recreation and related facilities, including pedestrian and bicycle trails, nature viewing areas, fishing and camping areas, and other similar activities that do not require permanent structures, provided that cleared areas and areas of compacted soil associated with these areas and facilities do not exceed eight percent of the preserved area.
- The preserved area may contain utilities and utility easements, but not septic systems. Utilities are defined as potable and wastewater underground piping, underground wiring, and power and telephone poles.
- All trees within the preserved area at the time of permit application shall be retained, aside from approved timber harvest activities regulated under WAC Title 222, except for Class IV General Forest Practices that are conversions from timberland to other uses, and the removal of dangerous or diseased trees. Dangerous or diseased trees that are removed shall be replanted with a similar species or a native species.
- The portion of the developed area which is not managed through full dispersion can be considered a separate project site provided that, the portion not managed through full dispersion is evaluated against and subject to thresholds in [Book 1, Chapter 1](#) to determine applicable minimum requirements.
- Additional impervious and lawn/landscaped areas are allowed, but should not drain to the native vegetation area, and are subject to the thresholds, treatment and flow control requirements.
- Within the context of this dispersion option, the impervious surfaces that are over and above the 10% maximum can be routed into an appropriately sized drywell or into an infiltration basin that meets the flow control standard and does not overflow into the forested or native vegetation area.

- Runoff shall evenly sheet flow onto dispersion areas naturally, or via a dispersion trench or other structure designed to evenly spread and dissipate concentrated flows.
- Runoff must be dispersed into the native area in accordance with one or more of the dispersion devices, and in accordance with the design criteria and limits for those devices, cited in this BMP. A native vegetation flow path of at least 100 feet in length (25 feet for sheet flow from a non-native pervious surface) must be available along the flow path that runoff would follow upon discharge from a dispersion device cited in this BMP. The native vegetated flow path must meet all of the following criteria:
  - The flow path must be over native vegetated surface.
  - The flow path must be on-site or in an off-site tract or easement area reserved for such dispersion.
  - The slope of the flow path must be no steeper than 15% for any 20-foot reach of the flow path.
  - Slopes up to 33% are allowed where level spreaders are located upstream of the dispersion area and at sites where vegetation can be established.
  - The flow path must be located between the dispersion device and any downstream drainage feature such as a pipe, ditch, stream, river, pond, lake, or wetland.
  - The flow paths for adjacent dispersion devices must be sufficiently spaced to prevent overlap of flows in the flow path areas.
- For sites with on-site sewage disposal systems, the discharge of runoff from dispersion devices must be located downslope of the primary and reserve drainfield areas. This requirement may be waived by the Responsible Official if site topography clearly prevents discharged flows from intersecting the drainfield.
- Dispersion devices are not allowed in critical area buffers or on slopes steeper than 20%. Dispersion devices proposed on slopes steeper than 15% or within 50 feet of a geologically hazardous area (Clark County Code 40.430 geologic Hazard Areas) must be approved by a geotechnical engineer or engineering geologist.
- The dispersion of runoff must not create flooding or erosion impacts.

### Roof Downspouts

- Roof surfaces are considered to be "fully dispersed" only if they are within a threshold discharge area that is or will be more than 65% forested (or native vegetative cover) and less than 10% impervious AND if they either:
  - Comply with the Downspout Dispersion requirements of [BMP T5.10C](#), but with vegetated flow paths of 100 feet or more through the native vegetation preserved area or,
  - Disperse the roof runoff along with the road runoff in accordance with the roadway dispersion BMP section (below).

### Driveway Dispersion

- Driveway surfaces are considered to be "fully dispersed" if they are within a threshold discharge area that is or will be more than 65% forested (or native vegetative cover) and less than 10% impervious AND if they either:
  - Comply with the requirements for Concentrated Flow Dispersion ([BMP T5.11](#)) and for Sheet Flow Dispersion (above) and have flow paths of 100 feet or more through native vegetation or,
  - Disperse driveway runoff along with the road runoff in accordance with the roadway dispersion BMP section (below).

### Roadway Dispersion

- Roadway surfaces are considered to be "fully dispersed" if they are within a threshold discharge area that is or will be more than 65% forested (or native vegetative cover) and less than 10% impervious AND if they comply with the following requirements:
  - The road section must minimize collection and concentration of roadway runoff. Sheet flow over roadway fill slopes (i.e., where roadway subgrade is above adjacent right-of-way) should be used wherever possible to avoid concentration.
  - When it is necessary to collect and concentrate runoff from the roadway and adjacent upstream areas (such as a ditch on a cut slope), concentrated flows must be incrementally discharged from the ditch through cross culverts or at the ends of cut sections. These incremental discharges are required to be below 0.5 cfs at any discharge point from a ditch for the 100-year runoff event.
    - Where flows at a particular ditch discharge point were already concentrated under existing site conditions (e.g., in a natural channel that crosses the roadway alignment), the 0.5-cfs limit would be in addition to the existing concentrated peak flows.
  - Ditch discharge points with up to 0.2 cfs discharge for the peak 100-year flow must use rock pads or dispersion trenches (criteria defined below) to disperse flows. Ditch discharge points with 100-year peak flows between 0.2 and 0.5 cfs must use dispersion trenches to disperse flows.
- Dispersion trenches must be designed to accept surface flows (free discharge) from a pipe, culvert, or ditch end. The trenches must be:
  - Aligned perpendicular to the flow path.
  - At least 2 feet by 2 feet in section.
  - At least 50 feet in length.

- Filled with ¾-inch to 1½-inches washed rock, and provided with a level notched grade board.
- Manifolds may be used to split flows up to 2 cfs discharge for the 100-year peak flow between up to 4 trenches. Dispersion trenches must be spaced at least 50 feet apart (between centerlines).
- Flow paths from adjacent discharge points must not intersect within the 100-foot flow path lengths, and dispersed flow from a discharge point must not be intercepted by another discharge point. To enhance the flow control and water quality effects of dispersion, the flow path shall not exceed 15% slope, and shall be located within designated open space.

Note: Runoff may be conveyed to an area meeting the above-noted flow path criteria.

- Ditch discharge points shall be located a minimum of 100 feet upgradient of steep slopes (slopes steeper than 40%), wetlands, and streams.
- Where Clark County determines there is a potential for significant adverse impacts downstream during plan approval, dispersion of roadway runoff may not be allowed, or other measures may be required.

### Cleared Area Dispersion

- The runoff from cleared areas that are comprised of bare soil, non-native landscaping, lawn, and/or pasture of up to 25 feet in flow path length can be considered to be "fully dispersed" if it is dispersed through at least 25 feet of native vegetation following these criteria:
  - The topography of the non-native pervious surface must be such that runoff will not concentrate prior to discharge to the dispersal area.
  - Slopes within the dispersal area must not exceed 15%.
  - If the width of the non-native pervious surface is greater than 25 feet, an extra foot of vegetated flow path is required for each additional 3 feet of non-impervious surface width (up to a maximum of 250 feet).

### Public Road Projects

The following criteria are for the construction of public roads outside the context of residential, commercial or industrial development.

- For uncollected or natural dispersal into vegetated areas, full dispersion credit (no other treatment or flow control required) is given if these criteria are met:
  - If the soil has an initial hydraulic conductivity of at least 4 inches per hour (Based on a Pilot Infiltration Test or Soil Grain Size Analysis—this will occur for group 1 soils and possibly some group 2 soils), 10 feet of dispersion area width for 20 feet of impervious flow path and an additional 0.25 feet of dispersion area for each additional foot of impervious flow path is required.

- For other soils, the dispersion area must be a minimum of 100 feet wide. 6.5 feet of dispersion area width is needed for every 1 foot of impervious area.
- For all soils:
  - A minimum depth to seasonal high groundwater elevation of 3 feet is required.
  - Impervious flow path shall be less than 75 feet and pervious flow path shall be less than 150 feet.
  - The lateral slope of the impervious drainage area shall be no more than 8%. Road side slopes shall be less than 25%. Road side slopes do not qualify as part of the dispersion area unless native vegetation is re-established and slopes are less than 15%. Road shoulders that are paved or graveled to withstand vehicle loads count as impervious area.
  - Longitudinal slope of the road shall be at most 5%.
  - The length of the dispersion area shall be equivalent to the length of the road.
  - Average slope of the dispersion area in the direction parallel to the road shall be no more than 15%.
  - Average lateral slope of the dispersion area shall be no more than 15%.
- For channelized stormwater into areas with native vegetation or cleared land outside of Urban Growth Areas without a natural or man-made system, full dispersion credit (no other treatment or flow control required) is given if these criteria are met:
  - If the soil has an initial hydraulic conductivity of at least 4 inches per hour (Based on a Pilot Infiltration Test or Soil Grain Size Analysis—this will occur for Group 1 soils and possibly some group 2 soils), dispersion area shall be at least ½ of the impervious drainage area.
  - For other soils, the dispersion area must be a minimum of 100 feet wide. 6.5 feet of dispersion area width is needed for every 1 foot of impervious area.
  - For all soils:
    - A minimum depth to seasonal high groundwater elevation of 3 feet is required.
    - Channels shall be re-dispersed to produce the longest possible flow path.
    - Flows shall be evenly dispersed across the dispersion area.

- Flows shall be dispersed using rock pads and dispersion techniques specified under roadway dispersion.
  - Approved energy dissipation may be used.
  - Length of the dispersion area shall be equivalent to the length of the road.
  - Average lateral and longitudinal slope of the dispersion area shall be no more than 8%.
  - The slope of any flow path segment shall not exceed 15% for any 20 foot reach.
- For engineered dispersal of stormwater into areas with engineered soils, full dispersion credit (no other treatment or flow control required) is given if these criteria are met:
  - Stormwater can be dispersed as sheet flow or via collection and re-dispersion according to the techniques for roadway dispersion.
  - A minimum depth to seasonal high groundwater elevation of 3 feet is required.
  - Soils must be compost amended (see [BMP T5.13: Post-Construction Soil Quality and Depth](#)).
  - For soils that meet or exceed a hydraulic conductivity of 4 inches per hour, 10 feet of dispersion area width for 20 feet of impervious flow path and an additional 0.25 feet of dispersion area for each additional foot of impervious flow path is required.
  - For other soils, the dispersion area must be a minimum of 100 feet wide and 6.5 feet of dispersion area width is needed for every 1 foot of impervious area.
  - Lateral and longitudinal slope of the dispersion area shall not exceed 15%.
  - The dispersion area should be planted with native trees and shrubs.
- Dispersal areas shall be outside of the urban growth area or (if inside the urban growth area) in legally protected areas such as public parks or conservation tracts.
- If outside urban growth areas, legal agreements should be reached with property owners of dispersal areas subject to stormwater that has been collected and is being re-dispersed.

### Native Vegetation Landscape Specifications

These specifications may be used in situations where an applicant wishes to convert a previously developed surface to a native vegetation landscape for purposes of meeting full dispersion requirements or code requirements for forest retention. Native vegetation landscape is intended to have the soil, vegetation, and runoff characteristics approaching that of natural forestland.

Conversion of a developed surface to native vegetation landscape requires the removal of impervious surface, de-compaction of soils, and the planting of native trees, shrubs, and ground cover in compost-amended soil according to all of the following specifications:

1. Existing impervious surface and any underlying base course (e.g., crushed rock, gravel) must be completely removed from the conversion area(s).
2. Underlying soils must be broken up to a depth of 18 inches. This can be accomplished by excavation or ripping with either a backhoe equipped with a bucket with teeth, or a ripper towed behind a tractor.
3. At least 4 inches of well-decomposed compost must be tilled into the broken up soil as deeply as possible. The finished surface should be gently undulating and must be only lightly compacted.
4. The area of native vegetated landscape must be planted with native species trees, shrubs, and ground cover. Species must be selected as appropriate for site shade and moisture conditions, and in accordance with the following requirements:
  - a. Trees: a minimum of two species of trees must be planted, one of which is a conifer. Conifer and other tree species must cover the entire landscape area at a spacing recommended by a professional landscaper.
  - b. Shrubs: a minimum of two species of shrubs should be planted. Space plants to cover the entire landscape area, excluding points where trees are planted.
  - c. Groundcover: a minimum of two species of ground cover should be planted. Space plants so as to cover the entire landscape area, excluding points where trees or shrubs are planted.

*Note: for landscape areas larger than 10,000 square feet, planting a greater variety of species than the minimum suggested above is strongly encouraged. For example, an acre could easily accommodate three tree species, three species of shrubs, and two or three species of groundcover.*

5. At least 4 inches of hog fuel or other suitable mulch must be placed between plants as mulch for weed control. It is also possible to mulch the entire area before planting; however, an 18-inch diameter circle must be cleared for each plant when it is planted in the underlying amended soil.

Note: plants and their root systems that come in contact with hog fuel or raw bark have a poor chance of survival.

6. Plantings must be watered consistently once per week during the dry season for the first two years.

7. The plantings must be well established on at least 90% of the converted area. A minimum of 90% plant survival is required after 3 years.

Conversion of an area that was under cultivation to native vegetation landscape requires a different treatment. Elimination of cultivated plants, grasses and weeds is required before planting and will be required on an on-going basis until native plants are well-established. The soil should be tilled to a depth of 18 inches. A minimum of 8 inches of soil having an organic content of 6 to 12 percent is required, or a four inch layer of compost may be placed on the surface before planting, or 4 inches of clean wood chips may be tilled into the soil, as recommended by a landscape architect or forester. After soil preparation is complete, continue with steps 4 through 7 above. Placing 4 inches of compost on the surface may be substituted for the hog fuel or mulch. For large areas where frequent watering is not practical, bare-root stock may be substituted at a variable spacing from 10 to 12 feet o.c. (with an average of 360 trees per acre) to allow for natural groupings and 4 to 6 feet o.c. for shrubs. Allowable bareroot stock types are 1-1, 2-1, P-1 and P-2. Live stakes at 4 feet o.c. may be substituted for willow and red-osier dogwood in wet areas.

### **Runoff Modeling Representation**

- Areas that are fully dispersed are not required to be modeled using an approved continuous flow model. See [Appendix 2-C](#) for partial modeling credits available.



## BMP T5.30B: Dispersion to Pasture or Cropland

---

### Purpose and Description

This LID BMP consists of fully dispersing runoff by directing it onto a pasture or cropland surface where it can be dispersed, infiltrated, evaporated, and consumed by plant uptake.

### Cross Reference Guide

Soils Assessment	None
Minimum Requirements	MR #5
Related BMPs	<a href="#">BMP T5.30A.</a>
Selection/Infeasibility Criteria	<a href="#">Book 1, Section 2.5.3</a>
Maintenance	None



**Figure 2.30: Cropland in Clark County Suitable for Full Dispersion to Pasture or Cropland**

## Applications, Limitations and Setbacks

On a single-family residential lot or an agriculture parcel or parcels under the same ownership and greater than 22,000 square feet, full dispersion onto pasture and croplands is allowed when in compliance with the following criteria:

- Crop land shall consist of land used to grow grass, grain, or row crops also including berries, nursery stock and orchards.
- The crop or pasture land shall be under the same ownership as the project site.
- The total site area shall consist of at least 75 percent cropland, and no more than 15 percent of the site draining to the dispersion area shall be impervious surfaces. Less stringent ratios of sending land and receiving land uses may be submitted, with supporting modeling results showing flow control requirements are satisfied for the site.
- No more than 10 percent of the pasture or cropland used for dispersion shall be used for purposes other than plant growth (for example, but not limited to, unpaved roads, staging areas, equipment storage, animal pens, haystacks, wheel lines, campsites, trails, etc.).
- Runoff from a driveway through the dispersion area shall be dispersed per [BMP T5.11](#) or [BMP T5.12](#) and shall have a flow path exceeding 300 feet.
- Land used for dispersion shall be downslope from building sites and shall not exceed 5% slope.
- There shall be a minimum 3-foot depth to the average annual maximum groundwater elevation.
- The length used for dispersion shall be 300 feet or greater.
- The preserved area is not required to be placed in a separate tract or recorded easement.
- The Applications, Limitations and Setbacks for [BMP T5.30A](#) shall also apply to this BMP. Where conflicts between the requirements in [BMP T5.30A](#) and the requirements in this BMP occur, the requirements for this BMP shall apply.

### Setbacks

- 100 feet upgradient from any septic system unless site topography clearly indicates that subsurface flows will not intersect the drainfield.
- 10 feet from any structure, property line, or sensitive area.
- 50 feet from a geohazard area per [CCC 40.430](#).

### Design Criteria

Runoff shall evenly sheet flow onto dispersion areas naturally or via a dispersion trench or other structure designed to evenly spread and dissipate concentrated flows into sheet flow.

## Runoff Modeling Representation

The land use where this BMP is applied shall be considered “fully dispersed” (i.e., zero percent effective impervious).

## BMP T5.40: Preserving Native Vegetation

---

### Purpose and Description

Preserving native vegetation on site to the maximum extent practicable minimizes the impacts of stormwater runoff from development. The property owner is ultimately responsible for protecting as many trees as possible, as well as their understory and groundcover. Forest and native growth areas allow rainwater to naturally percolate into the soil, recharging groundwater and reducing the erosion and flooding resulting from surface water runoff. It is preferred for 65% or more of the development site to be protected for the purposes of retaining or enhancing existing forest cover and preserving wetlands and stream corridors. On lots that are one acre or greater, preservation of 65% or more of the site in native vegetation will allow the use of full dispersion (see [BMP T5.30A](#)). Sites that can fully disperse are not required to provide runoff treatment or flow control facilities.



**Figure 2.31: Trees Preserved on a Development Site**

(Source: Clark County)

## Cross Reference Guide

Soils Assessment	None
Minimum Requirements	MR #5
Related BMPs	None.
Selection/Infeasibility Criteria	None
Maintenance	None

## Applications, Limitations and Setbacks

New development often takes place on tracts of forested land. In fact, building sites are often selected because of the presence of mature trees. However, unless sufficient care is taken and planning done, in the interval between buying the property and completing construction much of this resource is likely to be destroyed. The property owner is ultimately responsible for protecting as many trees as possible, with their understory and groundcover. This responsibility is usually exercised by agents, the planners, designers and contractors. It takes 20 to 30 years for newly planted trees to provide the benefits for which trees are so highly valued.

Forest and native growth areas allow rainwater to naturally percolate into the soil, recharging groundwater for summer stream flows and reducing surface water runoff that creates erosion and flooding. Conifers can hold up to about 50 percent of all rain that falls during a storm. Twenty to 30 percent of this rain may never reach the ground but evaporates or is taken up by the tree. Forested and native growth areas also may be effective as stormwater buffers around smaller developments.

On lots that are one acre or greater, preservation of 65 percent or more of the site in native vegetation will allow the use of full dispersion techniques presented in [BMP T5.30A](#). Sites that can fully disperse are not required to provide runoff treatment or flow control facilities.

## Design Criteria

- The preserved area should be situated to minimize the clearing of existing forest cover, to maximize the preservation of wetlands, and to buffer stream corridors.
- The preserved area should be placed in a separate tract or protected through recorded easements for individual lots.
- If feasible, the preserved area should be located downslope from the building sites, since flow control and water quality are enhanced by flow dispersion through duff, undisturbed soils, and native vegetation.

- The preserved area should be shown on all property maps and should be clearly marked during clearing and construction on the site.
- The preserved area must be protected during construction using the following techniques:
  - Secure visible fencing around the preserved vegetation at or beyond the dripline.
  - Do not stockpile materials within the fenced protection area.
  - Do not disturb the ground within the fenced protection area.
- The preserved area must be marked after construction is complete with at least one sign placed every 150' around the perimeter declaring the area as a protected natural area. See ~~Figure 9.11~~ Figure 1.14 in Book 1, Standard Clark County Vegetation Preservation Sign, for required signage.

### Runoff Modeling Representation

- None.

## BMP T5.41: Better Site Design

---

### Purpose and Description

The site planning principles in this section help to locate development on the least sensitive portions of a site and allow for development with the least possible stormwater impacts. Fundamental hydrological concepts and stormwater management concepts can be applied at the site design phase that are:

- More integrated with natural topography.
- Reinforce the hydrologic cycle.
- More aesthetically pleasing.
- Often less expensive to build.



**Figure 2.32: Example from Cold Creek Crossing of LID Integration with Site Design**

(Source: Clark County)

### Cross Reference Guide

Soils Assessment	None
Minimum Requirements	MR #5
Related BMPs	None
Selection/Infeasibility Criteria	None

## Cross reference guide (continued)

Maintenance	None
-------------	------

### Design Criteria

- **Define Development Envelope and Protected Areas** - The first step in site planning is to define the development envelope. This includes identifying protected areas, setbacks, easements and other site features as well as consulting applicable standards and requirements in Title 40 of the Clark County Code. Features to be protected can include:
  - Important existing trees.
  - Steep slopes.
  - Erosive soils.
  - Riparian areas.
  - Wetlands.

A compact development envelope can help minimize environmental impacts, reduce construction costs and preserve aesthetically pleasing landscape features.

- **Minimize Directly Connected Impervious Areas** - Impervious areas directly connected to the storm drain system are the greatest contributors to urban nonpoint source pollution. Any impervious surface that drains into a catch basin or other conveyance structure is a “directly connected impervious surface.” Minimizing these areas can be done by limiting overall impervious land coverage or by infiltrating and/or dispersing runoff from these areas.
- **Maximize Permeability** – Steps towards maximizing permeability include limiting impervious areas, paving with permeable materials, clustering buildings and by designing buildings with smaller footprints. Permeable/porous pavements can be used in place of traditional concrete or asphalt pavements in many low traffic applications.

Maximizing permeability at every opportunity requires the integration of many small strategies, from site planning to material selection.

In addition to the environmental and aesthetic benefits, a high-permeability site plan may allow the reduction or elimination of expensive runoff underground conveyance systems, flow control and treatment facilities, saving money on development costs.

- **Build Narrower Streets** - Street design carries with it key impacts on stormwater quantity. In residential development, streets and other transportation-related structures often comprise between 60 and 70 % of the total impervious area. Additionally, streets are almost always directly connected to the stormwater conveyance system. Street design is described in Clark County Code, Title 40. Most local standards require large areas with impervious surfaces. In recent years, new standards that reduce impervious land coverage have been gaining acceptance. These standards generally create a new class of street that is narrower than the usual local street



standards, called an “access” street. An access street is intended only to provide access to a limited number of residences.

Because street design is the greatest factor in residential development impact on stormwater quality, it is important that designers, municipalities and developers employ street standards that reduce impervious land coverage.

- **Maximize Choices for Mobility** – Designing developments in ways that promote alternatives to automobile use mitigates one of the primary causes of stormwater pollution.
  - Bicycle lanes and paths, secure bicycle parking at community centers and shops, direct, safe pedestrian connections, and transit facilities are all site-planning elements that can indirectly improve stormwater quality.
  - Ensure safety and access measures are installed in accordance with the Uniform Building Code and Americans with Disabilities Act. Ensure paths are located above the 10-year flood elevation.
- **Use Drainage as a Design Element** - Drainage systems for stormwater infiltration or dispersion can work with natural land forms and land uses to become an aesthetic element of a site plan.
- **Coordinate Stormwater Management Design Techniques** with other compatible site elements such as pathways, trails, open spaces, landscape area and building sites to maximize compatible uses and complimentary settings.
- **Incorporate Interpretation** such as educational or interpretive signage where feasible to describe the stormwater management techniques used on the site and their effect on surface waters.

### Resource Material

*Start at the Source. Residential Site Planning & Design Guidance Manual for Stormwater Quality Protection.* Bay Area Stormwater Management Agencies Association. January 1997.

*Site Planning for Urban Stream Protection.* Center for Watershed Protection. December, 1995.

*Better Site Design: A Handbook for Changing Development Rules in Your Community.* Center for Watershed Protection. August 1998.

<http://www.stormwatercenter.net>

This page intentionally left blank.

# Chapter 3 Runoff Treatment Facility Design

## Chapter Contents

<b>3.1</b>	<b>General Design Criteria</b> .....	<b>121</b>
3.1.1	Design Volume and Flow.....	121
3.1.1.1	Water Quality Design Storm Volume.....	121
3.1.1.2	Water Quality Design Flow Rate.....	121
3.1.2	Flows Requiring Treatment.....	122
3.1.2.1	Summary of Areas Needing Treatment.....	122
3.1.2.2	Recommendations for Reducing Flows to Treatment Facilities.....	122
3.1.3	Sequence of Facilities.....	123
3.1.4	Setbacks, Slopes, and Embankments.....	124
3.1.4.1	Setbacks.....	124
3.1.4.2	Side Slopes.....	125
3.1.5	Infiltration Facility Sizing.....	126
3.1.5.1	Allowable Facility Infiltration Rates.....	127
3.1.5.2	Drawdown Time.....	127
3.1.5.3	Soil Physical and Chemical Suitability for Treatment.....	127
3.1.6	Facility Liners.....	128
3.1.6.1	Liner Design Criteria.....	128
3.1.6.2	Design Criteria for Low Permeability Liner Options.....	130
3.1.7	Hydraulic Structures.....	131
3.1.7.1	Flow Splitters.....	131
3.1.7.2	General Design Criteria.....	132
3.1.7.3	Materials.....	132
3.1.7.4	Flow Spreaders.....	134

## Chapter Figures

Figure 3.1:	Flow Splitter - Option A.....	133
Figure 3.2:	Flow Splitter - Option B.....	134
Figure 3.3:	Flow Spreader Option 1 - Clark County Flow Spreader with Sediment Trap.....	138

Figure 3.4: Flow Spreader Option 2 - Anchored Plate.....	139
Figure 3.5: Flow Spreader Option 3 - Concrete Sump Box .....	140
Figure 3.6: Flow Spreader Option 4 - Notched Curb Spreader.....	141
Figure 3.7: Flow Spreader Option 5 - Through-Curb Port .....	142

## Chapter Tables

Table 3.1: Treatment Facility Placement in Relation to Detention .....	124
Table 3.2: Stormwater Infiltration Facility Setbacks .....	125
Table 3.3: Stormwater Treatment Facility Side Slopes .....	126
Table 3.4: Lining Types Recommended for Runoff Treatment Facilities.....	129

## 3.1 General Design Criteria

This section addresses general design requirements for treatment facilities. These include design volumes and flows, sequencing of facilities, infiltration design for treatment liners, and hydraulic structures for splitting or dispersing flows.

### 3.1.1 Design Volume and Flow

Size stormwater treatment facilities for the entire area that drains to them, even if some of those areas are not pollution-generating or were not included in the project site threshold decisions in [Book 1, Section 1.4](#) or the treatment threshold decisions of Minimum Requirement #6 (see [Book 1, Section 1.5.6](#)).

#### 3.1.1.1 Water Quality Design Storm Volume

The water quality design storm volume is the volume of runoff predicted from a 24-hour storm with a 6-month return frequency (a.k.a., 6-month, 24-hour storm). Alternatively, when using an approved continuous flow model, the water quality design storm volume shall be equal to the simulated daily volume that represents the upper limit of the range of daily volumes that accounts for 91% of the entire runoff volume over a multi-decade period of record.

Wetpool facilities are sized based upon use of the NRCS curve number equations in [Appendix 2-A](#) for the 6-month, 24-hour storm. Treatment facilities sized by this simple runoff volume-based approach are the same size whether they precede detention, follow detention, or are integral with the detention facility (i.e., a combined detention and wetpool facility).

The 6-month, 24-hour precipitation amount is assumed to be 70 percent of the 2-year, 24-hour amount for Clark County. For other areas, interpolating between isopluvials for the 2-year, 24-hour precipitation and multiplying by 70% yields the appropriate storm size. Isopluvials for 2-year, 24-hour amounts for Western Washington can be found in [Appendix 2-A](#).

#### 3.1.1.2 Water Quality Design Flow Rate

The water quality design flow rate for treatment facilities placed downstream of detention facilities is the full 2-year release rate from the detention facility. An approved continuous flow model must be used to identify the 2-year return frequency flow rate discharged by a detention facility that is designed to meet the flow duration standard.

The water quality design flow rate for treatment facilities preceding detention facilities or when detention facilities are not required is the flow rate at or below which 91% of the runoff volume, as estimated by an approved continuous flow model, will be treated at the water quality design flow rate. At a minimum, 91% of the total runoff volume, as estimated by an approved continuous flow

model, must pass through the treatment facility(ies) at or below the approved hydraulic loading rate for the facility(ies).

All BMPs except wetpool-types must use the 15-minute time series from an approved continuous flow model.

Design criteria for treatment facilities are assigned to achieve the applicable performance goal at the water quality design flow rate.

- *Off-line facilities:* For treatment facilities not preceded by an equalization or storage basin, and when runoff flow rates exceed the water quality design flow rate, the treatment facility must continue to receive and treat the water quality design flow rate to the applicable treatment performance goal. Only the higher incremental portion of flow rates is bypassed around a treatment facility.

Treatment facilities preceded by an equalization or storage basin may identify a lower water quality design flow rate provided that at least 91 percent of the estimated runoff volume in the time series of an approved continuous flow model is treated to the applicable performance goals (e.g., 80 percent TSS removal at the water quality design flow rate).

- *On-line facilities:* Runoff flow rates in excess of the water quality design flow rate can be routed through the facility provided a net pollutant reduction is maintained.

### 3.1.2 Flows Requiring Treatment

Runoff from pollution-generating hard surface (PGHS), pollution-generating pervious surface (PGPS), and pollution-generating impervious surface (PGIS) must be treated. The glossary in [Appendix 1-A](#) provides definitions of these terms.

#### 3.1.2.1 Summary of Areas Needing Treatment

- All runoff from PGHS is to be treated through a runoff treatment BMP. Lawns and landscaped areas are pervious but can generate run-off into street drainage systems. In those cases the runoff from the pervious areas must be estimated and added to the runoff from hard surface areas to size treatment facilities.
- If runoff from non-pollution generating surfaces reaches a runoff treatment BMP, flows from those areas must be included in the sizing calculations for the facility. Once runoff from non-pollution generating areas is mixed with runoff from pollution-generating areas, it cannot be separated before treatment.

#### 3.1.2.2 Recommendations for Reducing Flows to Treatment Facilities

- Use On-site Stormwater Management BMPs to the maximum extent practicable (see [Book 1, Chapter 2](#)).

- Runoff from backyards may drain into native vegetation in areas designated as open space or buffers. In these cases, the area in native vegetation may be used to provide the requisite water quality treatment, provided it meets the requirements under the “Cleared Area Dispersion BMPs,” of [BMP T5.30A](#) Full Dispersion.
- Drainage from hard surfaces that are not pollution-generating need not be treated and may bypass runoff treatment if it is not mingled with runoff from pollution-generating surfaces.
- Runoff from nonpollution-generating roofs (see definition of Pollution Generating Impervious Surface in [Appendix 1-A](#) for information on what roofs are pollution generating) is not required to be treated. The nonpollution-generating roof runoff that is directed to an infiltration drywell or trench must first pass through a catch basin (See [BMP T5.10A](#) and [BMP T5.10B](#)). Note that metal roofs are considered pollution generating unless they are coated with an inert non-leachable material. Roofs that are subject to venting of significant amounts of manufacturing, commercial, or other indoor pollutants are considered pollution-generating.
- Drainage from areas in native vegetation should not be mixed with untreated runoff from streets and driveways. It is best to infiltrate or disperse this relatively clean runoff to maximize recharge to shallow groundwater, wetlands, and streams.

### 3.1.3 Sequence of Facilities

The Enhanced Treatment and Phosphorus Menus (See [Book 1, Section 3.2.3](#)) include treatment options in which more than one type of treatment facility is used. In those options, the sequence of facilities is prescribed because the specific pollutant removal role of the second or third facility in a treatment train often assumes that significant solids settling have already occurred.

There is also the question of whether treatment facilities should be placed upstream or downstream of detention facilities. In general, all treatment facilities may be installed upstream of detention facilities, although presettling basins are needed for sand filters and infiltration basins. However, not all treatment facilities can function effectively if located downstream of detention facilities. For example, filter treatment devices may not properly engage to treat low flows discharged from detention facilities.

Oil control facilities must be located upstream of treatment facilities and as close to the source of oil-generating activity as possible. They should also be located upstream of detention facilities, if possible

[Table 3.1](#) summarizes placement considerations of treatment facilities in relation to detention.

**Table 3.1: Treatment Facility Placement in Relation to Detention**

<b>Water Quality Facility</b>	<b>Preceding Detention</b>	<b>Following Detention</b>
Basic biofiltration swale	OK	OK for use, but not ideal as prolonged flows may reduce grass survival. Consider wet biofiltration swale.
Wet biofiltration swale	OK	OK
Filter strip	OK	No—must be installed before flows concentrate.
Basic or large wetpond	OK	OK—less water level fluctuation in ponds downstream of detention may improve aesthetic qualities and performance.
Basic or large combined detention and wetpond	Not applicable	Not applicable
Wetvault	OK	OK
Basic or large sand filter or sand filter vault	OK for off-line facilities, but presettling and control of floatables needed	OK—sand filters downstream of detention facilities may require field adjustments if prolonged flows cause sand saturation and interfere with phosphorus removal.
Stormwater treatment wetland	OK	OK—less water level fluctuation and better plant diversity are possible if the stormwater wetland is located downstream of the detention facility.

Note: Emerging Technologies may be installed either upstream or downstream of detention facilities. The location depends on the type of technology and the level of treatment desired.

### 3.1.4 Setbacks, Slopes, and Embankments

The following guidelines for setbacks, slopes, and embankments are intended to provide for adequate maintenance accessibility as well as to address public health and safety concerns.

#### 3.1.4.1 Setbacks

Setbacks protect property, other utilities and natural resources from impacts from stormwater facilities; they also protect stormwater facilities from influence by other utilities and natural resources and allow room for maintenance access and equipment maneuverability.

Stormwater facilities shall be located in accordance with the county’s critical areas ordinances, [Chapters 40.410 through 40.450](#).



Stormwater treatment facilities shall be set back from existing and proposed on-site sewage system drainfields as follows:

- At least thirty (30) feet when downslope from the drainfield system
- At least ten (10) feet when upslope from the drainfield system
- At least one hundred (100) feet for infiltration and dispersion systems. This distance can be reduced upon submittal of a report prepared by a registered geotechnical engineer licensed in the state of Washington that provides evidence that neither system will be compromised by a closer proximity. All applicable state and federal regulations must still be followed.

Some BMPs may have specific setbacks that supersede the general setbacks given here, provided, the setback guideline for the BMP is more conservative.

### Stormwater Infiltration Facility Setbacks

Stormwater infiltration facilities used for treatment shall be set back according to [Table 3.2](#).

**Table 3.2: Stormwater Infiltration Facility Setbacks**

<b>Stormwater infiltration facility setback from:</b>	<b>Distance</b>
Drinking water wells	100 feet minimum
Building foundations	20 feet minimum from the downslope side of foundations 100 feet minimum from the upslope side of foundations These setbacks may be increased or decreased based on engineering analysis that shows the performance of the building's foundation system will not be adversely affected by the presence of the stormwater facility.
Slopes equal to or greater than 15%	50 feet minimum from the crests of slopes. This setback may be increased or decreased based on engineering analysis that shows the stability of the slope will not be adversely affected by the presence of the stormwater facility.

Setbacks for infiltration facilities may be reduced if a geotechnical report addresses potential impacts of trench phreatic surface on structures within twenty (20) feet of the proposed facility.

#### 3.1.4.2 Side Slopes

Side slopes must meet the criteria in [Table 3.3](#).

**Table 3.3: Stormwater Treatment Facility Side Slopes**

<b>Interior Side Slopes</b>	
All facilities with interior side slopes flatter than or equal to 3:1	Allowed
All facilities with slopes flatter than or equal to 2:1	Allowed if: <ul style="list-style-type: none"> <li>• Side slopes don't need mowing, and</li> <li>• Erosion control and slope stability are provided</li> </ul>
Public facilities, vertical slopes	Allowed if: <ul style="list-style-type: none"> <li>• Perimeter has less than or equal to 75% vertical slopes;</li> <li>• Vertical slopes more than two feet tall are fenced;</li> <li>• Maintenance access is adequate; and</li> <li>• Side slopes in a biofiltration treatment area are 3:1 or flatter.</li> <li>• The design is stamped by a licensed civil engineer with structural expertise.</li> </ul>
Private facilities, slopes steeper than 3:1	Allowed if: <ul style="list-style-type: none"> <li>• Perimeter has less than or equal to 75% vertical slopes;</li> <li>• Vertical slopes more than two feet tall are fenced;</li> <li>• Long-term erosion control is provided;</li> <li>• Side slopes in a biofiltration treatment area are 3:1 or flatter; and</li> <li>• It is demonstrated that the facility can be adequately maintained.</li> </ul>
<b>Exterior Side Slopes</b>	
All facilities with slopes flatter than or equal to 3:1	Allowed
All facilities with slopes flatter than or equal to 2:1	Allowed if: <ul style="list-style-type: none"> <li>• Side slopes don't need mowing, and</li> <li>• Erosion control and slope stability are provided</li> </ul>
Private facilities, slopes steeper than 2:1	Allowed if: <ul style="list-style-type: none"> <li>• Analyzed for stability by a geotechnical engineer</li> </ul>

### 3.1.5 Infiltration Facility Sizing

Infiltration facilities used for runoff treatment must infiltrate at least 91% of the influent runoff file. Infiltration facilities using this criterion can also be used to demonstrate compliance with the LID Performance Standard of Minimum Requirement #5. Sizing a facility for water quality treatment should use the following procedures:

1. Input the dimensions of the infiltration pond.

2. Input the infiltration rate and safety (rate reduction) factor. Input a riser height and diameter (any flow through the riser indicates that less than 91% infiltration and the infiltration pond dimensions must be increased).
3. Run only the Developed Mitigated Scenario in the approved continuous flow model. A duration analysis is not needed for this exercise.
4. Go back to the infiltration facility and review the Percentage Infiltrated at the bottom right. If less than 91% infiltrated, increase pond dimension until 91% is infiltrated.

### 3.1.5.1 Allowable Facility Infiltration Rates

For infiltration facilities used for treatment purposes, the measured soil infiltration rate shall be 9 inches per hour or less. The design infiltration rate must also be 0.5 inches per hour or more.

The design infiltration rate should also be used for maximum drawdown time and routing calculations.

### 3.1.5.2 Drawdown Time

When sizing a treatment facility document that the water quality design storm volume must be fully infiltrated within 48 hours. This can be calculated by multiplying the horizontal projection of the infiltration basin mid-depth dimensions by the estimated design infiltration rate, and multiplying the result by 48 hours.

### 3.1.5.3 Soil Physical and Chemical Suitability for Treatment

Consider the soil texture and design infiltration rates along with the physical and chemical characteristics specified below to determine if the soil is adequate for removing the target pollutants. The following criteria must be met to use the soil for treatment:

- Design infiltration rate must be 0.5 inches per hour or greater.
- Measured infiltration rate must be 9 inches per hour or less. Design (long-term) infiltration rates up to 3 inches/hour can also be considered, if in the judgment of the qualified professional, the treatment soil meets the characteristics specified in this section.
- Cation exchange capacity (CEC) of the treatment soil must be  $\geq 5$  milliequivalents CEC/100 g dry soil (USEPA Method 9081). *Consider empirical testing of soil sorption capacity, if practicable.* Ensure that soil CEC is sufficient for expected pollutant loadings, particularly heavy metals. CEC values of  $>5$  meq/100g are expected in loamy sands, according to Rawls, et al. Lower CEC content may be considered if it is based on a soil loading capacity determination for the target pollutants that is accepted by Clark County.

- Depth of soil used for infiltration treatment must be a minimum of 18 inches. Depth of soil below permeable pavements serving as pollution-generating hard surfaces may be reduced to one foot if the permeable pavement does not accept run-on from other surfaces.
- Organic Content of the treatment soil (ASTM D 2974): Organic matter can increase the sorptive capacity of the soil for some pollutants. A minimum of 1.0 percent organic content is necessary.
- Waste fill materials shall not be used as infiltration soil media nor shall infiltration soil media be placed over uncontrolled or non-engineered fill soils.
- For engineered soils or for soils with very low permeability, the potential to bypass the treatment soil through the side-walls may be significant. In those cases, line the side-walls with at least 18 inches of treatment soil to prevent seepage of untreated flows through the side walls. See this chapter for more information on treatment liners.

For soils that do not meet the requirements of this section, treatment liners may be used.

### 3.1.6 Facility Liners

Liners are intended to retain a water pool for facilities such as treatment wetlands and wetpools where used to provide treatment at sites where groundwater contamination is a concern.

Treatment liners amend the soil with materials that treat stormwater before it reaches more freely draining soils. They have slow rates of infiltration, generally less than 2.4 inches per hour, but not as slow as low permeability liners. Treatment liners may use in-place native soils or imported soils.

Low permeability liners reduce infiltration to a very slow rate, generally less than 0.02 inches per hour or prevent it altogether. Low permeability liners must be used on industrial or commercial sites with a potential for high pollutant loading in the stormwater runoff. Low permeability liners may be fashioned from compacted clay, geomembrane, or concrete.

#### 3.1.6.1 Liner Design Criteria

- [Table 3.4](#) shows recommendations for the type of liner generally best suited for use with various runoff treatment facilities.
- Liners shall be evenly placed over the bottom and/or sides of the treatment area of the facility as indicated in [Table 3.4](#).
- Areas above the treatment volume required to pass flows greater than the water quality treatment flow (or volume) need not be lined. However, the lining must be extended to the top of the interior side slope and anchored if it cannot be permanently secured by other means.

**Table 3.4: Lining Types Recommended for Runoff Treatment Facilities**

WQ Facility	Area to be Lined	Type of Liner Recommended
Presettling basin	Bottom and sides	Low permeability liner or Treatment liner (If the basin will intercept the seasonal high groundwater table, a treatment liner is recommended.)
Wetpond	First cell: bottom and sides to WQ design water surface ----- Second cell: bottom and sides to WQ design water surface	Low permeability liner or Treatment liner (If the wet pond will intercept the seasonal high groundwater table, a treatment liner is recommended.) ----- Treatment liner
Combined detention/WQ facility	First cell: bottom and sides to WQ design water surface ----- Second cell: bottom and sides to WQ design water surface	Low permeability liner or Treatment liner (If the facility will intercept the seasonal high groundwater table a treatment liner is recommended.) ----- Treatment liner
Stormwater wetland	Bottom and sides, both cells	Low permeability liner (If the facility will intercept the seasonal high groundwater table, a treatment liner is recommended.)
Sand filtration basin	Basin sides only	Treatment liner
Sand filter vault	Not applicable	No liner needed
Linear sand filter	Not applicable if in vault Bottom and sides of presettling cell if not in vault	No liner needed Low permeability or treatment liner
Media filter (in vault)	Not applicable	No liner needed
Wet vault	Not applicable	No liner needed
Biofiltration swale	Not applicable	No liner needed

- If a treatment liner will be below the seasonal high water level, the pollutant removal performance of the liner must be evaluated by a geotechnical or groundwater specialist and found to be as protective as if the liner were above the level of the groundwater.

- A two-foot thick layer of soil with a minimum organic content of 1.0% AND a minimum cation exchange capacity (CEC) of 5 milliequivalents/100 grams can be used as a treatment layer beneath a water quality or detention facility.
  - To demonstrate that in-place soils meet the above criteria, one sample per 1,000 square feet of facility area shall be tested. Each sample shall be a composite of subsamples taken throughout the depth of the treatment layer (usually two to six feet below the expected facility invert).
- Typically, side wall seepage is not a concern if the seepage flows through the same stratum as the bottom of the treatment BMP. However, if the treatment soil is an engineered soil or has very low permeability, the potential to bypass the treatment soil through the side walls may be significant. In those cases, the treatment BMP side walls should be lined with at least 18 inches of treatment soil, as described above, to prevent untreated seepage. This lesser soil thickness is based on unsaturated flow as a result of alternating wet-dry periods.
- Organic content shall be measured on a dry weight basis using ASTM D2974.
- Cation exchange capacity (CEC) shall be tested using EPA laboratory method 9081.
- Certification by a soils testing laboratory that imported soil meets the organic content and CEC criteria above shall be provided to the Responsible Official.
- Animal manures used in treatment soil layers shall be sterilized.

### 3.1.6.2 Design Criteria for Low Permeability Liner Options

#### For all Low Permeability Liners

- Where the seasonal high groundwater elevation is likely to contact a low permeability liner, liner buoyancy may be a concern. A low permeability liner shall not be used in this situation unless evaluated and recommended by a geotechnical engineer.
- Where grass must be planted over a low permeability liner per the facility design, a minimum of 6 inches of good topsoil or compost-amended native soil (2 inches compost tilled into 6 inches of native soil) must be placed over the liner in the area to be planted. Twelve inches of cover is preferred.

#### Clay Liners

- Liner thickness shall be 12 inches.
- Clay shall be compacted to 95% minimum dry density, modified proctor method (ASTM D-1557).
- A different depth and density sufficient to retard the infiltration rate to  $2.4 \times 10^{-5}$  inches per minute ( $1 \times 10^{-6}$  cm/s) may also be used instead of the above criteria.

- The slope of clay liners may not be steeper than 3:1 for all areas requiring soil cover; otherwise, the soil layer must be stabilized by another method so that soil slippage into the facility does not occur. Any alternative soil stabilization method must take maintenance access into consideration.
- Where clay liners form the sides of ponds, the interior side slope shall not be steeper than 3:1, irrespective of fencing, to ensure that anyone falling into the pond may safely climb out.

### Geomembrane Liners

- Geomembrane liners shall be ultraviolet (UV) light resistant and have a minimum thickness of 30 mils. A thickness of 40 mils shall be used in areas of maintenance access or where heavy machinery must be operated over the membrane.
- Geomembranes shall be bedded according to the manufacturer's specifications.
- Liners shall be installed so that they can be covered with 12 inches of top dressing forming the bottom and sides of the water quality facility, except for liner sand filters. Top dressing shall consist of 6 inches of crushed rock covered with 6 inches of native soil. The rock layer marks the location of the liner for future maintenance operations. Alternately, 12 inches of native soil may be used if orange plastic “safety fencing” or another highly-visible continuous marker is embedded 6 inches above the membrane.
- If possible, liners should be of a contrasting color so that maintenance workers are aware of any areas where a liner may have become exposed when maintaining the facility.
- Geomembrane liners shall not be used on slopes steeper than 5:1 to prevent the top dressing material from slipping. Textured liners may be used on slopes up to 3:1 upon recommendation by a geotechnical engineer that the top dressing will be stable for all site conditions, including maintenance.

### Concrete Liners

- Portland cement liners are allowed irrespective of facility size, and shotcrete may be used on slopes. However, specifications must be developed by a professional engineer who certifies the liner against cracking or losing water retention ability under expected conditions of operation, including facility maintenance operations with heavy equipment.
- Asphalt concrete shall not be used for liners.
- If grass is to be grown over a concrete liner, slopes must be no steeper than 5:1 to prevent the top dressing material from slipping.

## 3.1.7 Hydraulic Structures

### 3.1.7.1 Flow Splitters

Many water quality (WQ) facilities can be designed as flow-through or on-line systems with flows above the WQ design flow or volume simply passing through the facility at a lower pollutant

removal efficiency. However, it is sometimes desirable to restrict flows to WQ treatment facilities and bypass the remaining higher flows around them through off-line facilities.

*See Stormwater Management Manual for Western Washington 2014 Volume V, Chapter 4.5 for more general information about flow splitter designs and options.*

### 3.1.7.2 General Design Criteria

- A flow splitter must be designed to deliver the WQ design flow rate specified in this chapter to the treatment facility. For the basic size sand filter, which is sized based on volume, use the WQ design flow rate to design the splitter. For the large sand filter, use the 2-year flow rate or the flow rate that corresponds with treating 95 percent of the runoff volume of a long-term time series predicted by an approved continuous flow model.
- The top of the weir must be located at the water surface for the design flow. Remaining flows enter the bypass line. Flows modeled using a continuous flow should use 15-minute time steps, if available. Otherwise use 1-hour time steps.
- The maximum head must be minimized for flow in excess of the WQ design flow. Specifically, flow to the WQ facility at the 100-year water surface must not increase the design WQ flow by more than 10%.
- Either design shown in [Figure 3.1](#) or [Figure 3.2](#) or an equivalent design may be used.
- As an alternative to using a solid top plate in [Figure 3.2](#) a full tee section may be used with the top of the tee at the 100-year water surface. This alternative would route emergency overflows (if the overflow pipe were plugged) through the WQ facility rather than back up from the manhole.
- Special applications, such as roads, may require the use of a modified flow splitter. The baffle wall may be fitted with a notch and adjustable weir plate to proportion runoff volumes other than high flows.
- For ponding facilities, back water effects must be included in designing the height of the standpipe in the manhole.
- Ladder or step and handhold access must be provided. If the weir wall is higher than 36 inches, two ladders, one to either side of the wall, must be used.

### 3.1.7.3 Materials

- The splitter baffle may be installed in a Type 2 manhole or vault.
- The baffle wall must be made of reinforced concrete or another suitable material resistant to corrosion, and have a minimum 4-inch thickness. The minimum clearance between the top of the baffle wall and the bottom of the manhole cover must be 4 feet; otherwise, dual access points should be provided.
- All metal parts must be corrosion resistant. Zinc and galvanized materials are discouraged because of aquatic toxicity. Painted metal parts should not be used because of poor longevity.



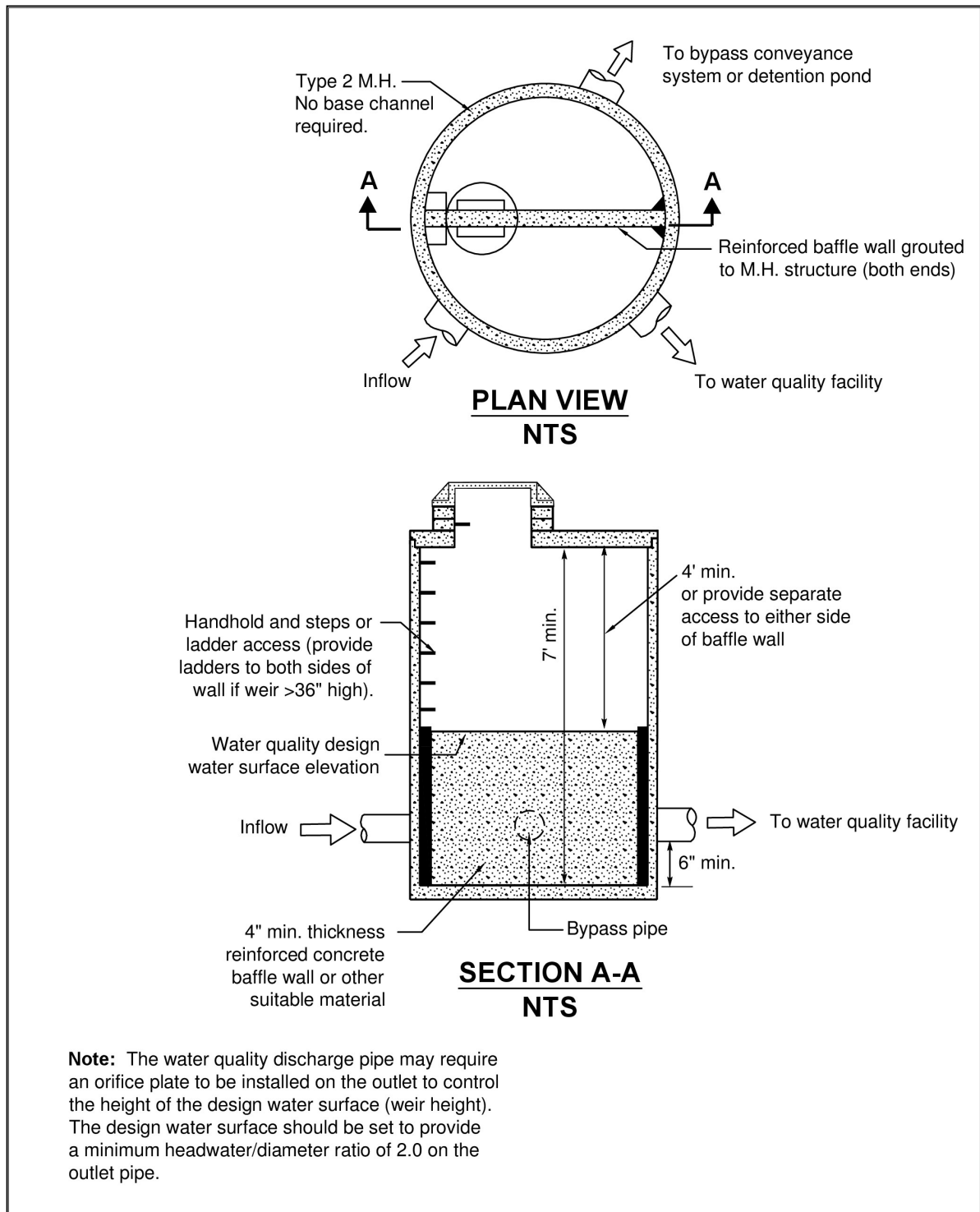
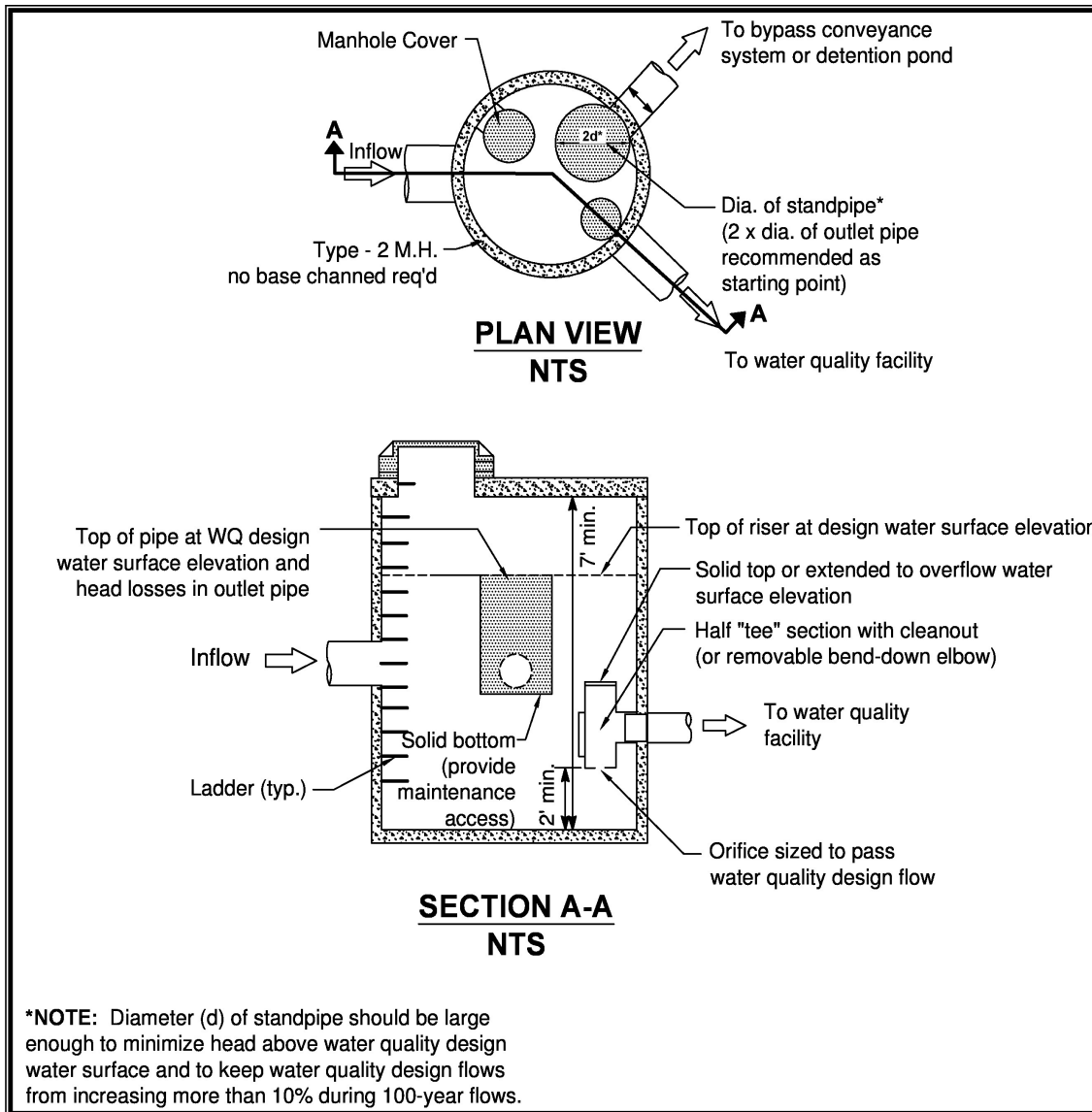


Figure 3.1: Flow Splitter - Option A



**Figure 3.2: Flow Splitter - Option B**

### 3.1.7.4 Flow Spreaders

Flow spreaders function to uniformly spread flows across the inflow portion of water quality facilities (e.g., sand filter, biofiltration swale, or filter strip). There are six flow spreader options presented in this section:

1. Clark County flow spreader with sediment trap
2. Anchored plate
3. Concrete sump box
4. Notched curb spreader

5. Through-curb ports
6. Interrupted curb

Option 1 is the preferred flow spreader for biofiltration swales. Options 1 through 4 can be used for spreading flows that are concentrated when spreading is required by the facility design criteria. Options 1 through 4 can also be used for unconcentrated flows, and in some cases must be used, such as to correct for moderate grade changes along a filter strip.

Options 5 and 6 are only for flows that are not concentrated and enter a filter strip or continuous inflow biofiltration swale. Other flow spreader options are possible with approval from the Responsible Official.

### General Design Criteria

- Where flow enters the flow spreader through a pipe, the pipe must be submerged to the extent practical to dissipate energy as much as possible.
- For higher inflows (greater than 5 cfs for the 100-yr storm), a Type 1 catch basin should be positioned in the spreader and the inflow pipe must enter the catch basin with flows exiting through the top grate. The top of the grate must be lower than the level spreader plate, or if a notched spreader is used, lower than the bottom of the v-notches.
- [Table 7.4](#) provides general guidance for rock protection at outfalls.

### Option 1 – Clark County Flow Spreader with Sediment Trap ([Figure 3.3](#))

- The concrete sump must have a minimum depth of 3 inches, a minimum length of 4 feet, and width of at least 6 inches greater than the width of the bioswale.
- A minimum of 2 removable aluminum trash screens must be installed 18” distant.
- See [Figure 3.3](#) for other requirements.

### Option 2 - Anchored Plate ([Figure 3.4](#))

- An anchored plate flow spreader must be preceded by a sump having a minimum depth of 8 inches and minimum width of 24 inches. If not otherwise stabilized, the sump area must be lined to reduce erosion and to provide energy dissipation.
- The top surface of the flow spreader plate must be level, projecting a minimum of 2 inches above the ground surface of the water quality facility, or V-notched with notches 6 to 10 inches on center and 1 to 6 inches deep (use shallower notches with closer spacing). Alternative designs may also be used.
- A flow spreader plate must extend horizontally beyond the bottom width of the facility to prevent water from eroding the side slope. The horizontal extent should be such that the bank is

protected for all flows up to the 100-year flow or the maximum flow that will enter the Water Quality (WQ) facility.

- Flow spreader plates must be securely fixed in place.
- Flow spreader plates may be made of either wood, metal, fiberglass reinforced plastic, or other durable material. If wood, pressure treated 4 by 10-inch lumber or landscape timbers are acceptable.
- Anchor posts must be 4-inch square concrete, tubular stainless steel, or other material resistant to decay.

### **Option 3 - Concrete Sump Box ([Figure 3.5](#))**

- The wall of the downstream side of a rectangular concrete sump box must extend a minimum of 2 inches above the treatment bed. This serves as a weir to spread the flows uniformly across the bed.
- The downstream wall of a sump box must have “wing walls” at both ends. Side walls and returns must be slightly higher than the weir so that erosion of the side slope is minimized.
- Concrete for a sump box can be either cast-in-place or precast, but the bottom of the sump must be reinforced with wire mesh for cast-in-place sumps.
- Sump boxes must be placed over bases that consists of 4 inches of crushed rock, 5/8-inch minus to help assure the sump remains level.

### **Option 4 - Notched Curb Spreader ([Figure 3.6](#))**

Notched curb spreader sections must be made of extruded concrete laid side-by-side and level. Typically five “teeth” per four-foot section provide good spacing. The space between adjacent “teeth” forms a v-notch.

### **Option 5 - Through-Curb Ports ([Figure 3.7](#))**

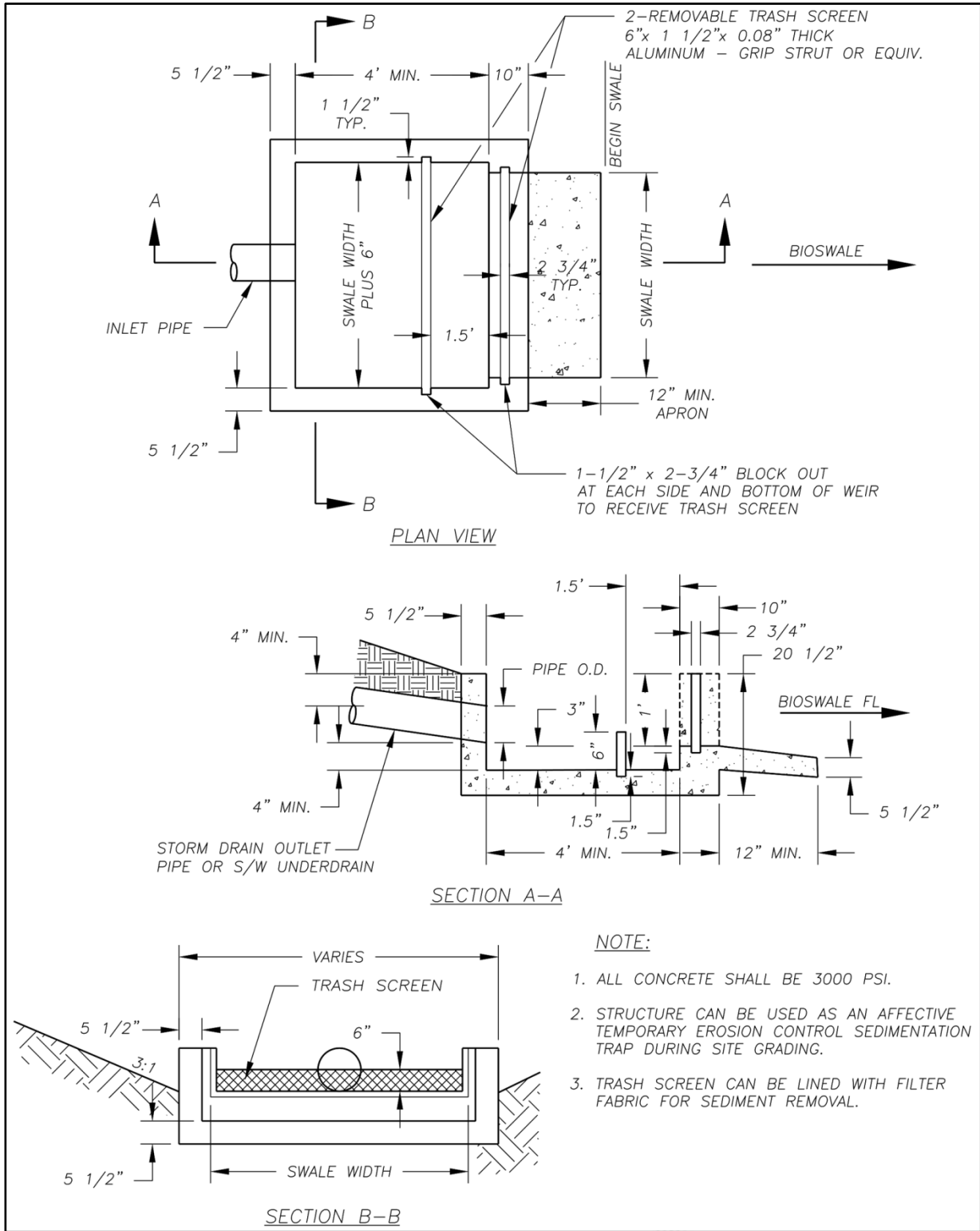
Unconcentrated flows from paved areas entering filter strips or continuous inflow biofiltration swales can use curb ports or interrupted curbs (Option 5) to allow flows to enter the strip or swale.

Curb ports use fabricated openings that allow concrete curbing to be poured or extruded while still providing an opening through the curb to admit water to the WQ facility.

Openings in the curb must be at regular intervals but every 6 feet at minimum. The width of each curb port opening must be a minimum of 11 inches. Approximately 15 percent or more of the curb section length should be in open ports, and no port should discharge more than about 10 percent of the flow.

### Option 6 - Interrupted Curb (No Figure)

Interrupted curbs are sections of curb placed to have gaps spaced at regular intervals along the total width (or length, depending on facility) of the treatment area. At a minimum, gaps must be every 6 feet to allow distribution of flows into the treatment facility before they become too concentrated. The opening must be a minimum of 11 inches. As a general rule, no opening should discharge more than 10 percent of the overall flow entering the facility.



**Figure 3.3: Flow Spreader Option 1 - Clark County Flow Spreader with Sediment Trap**

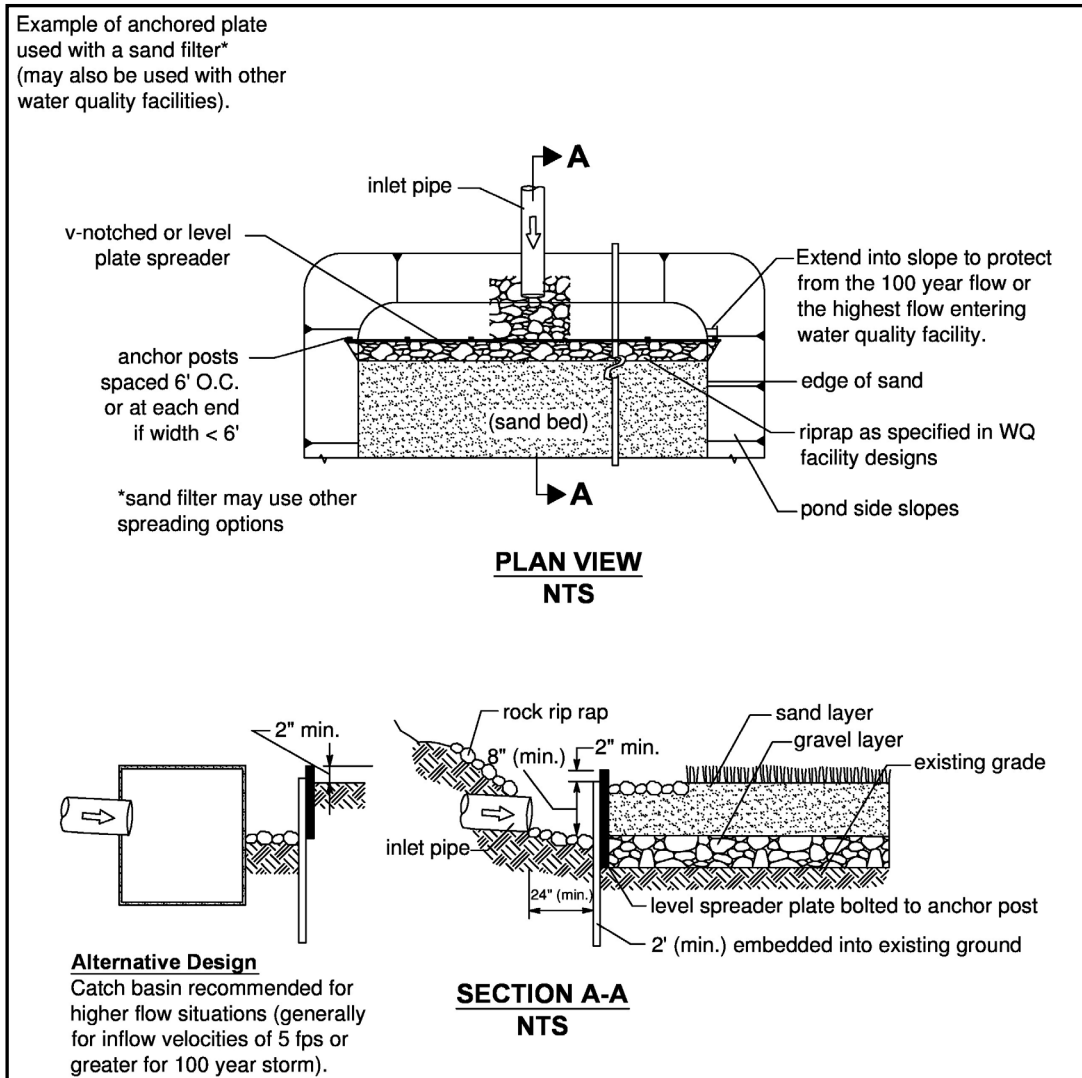
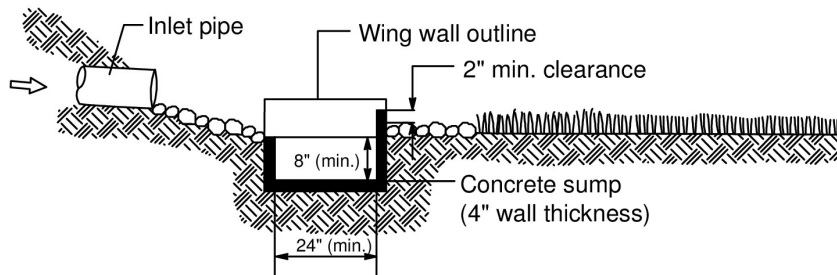
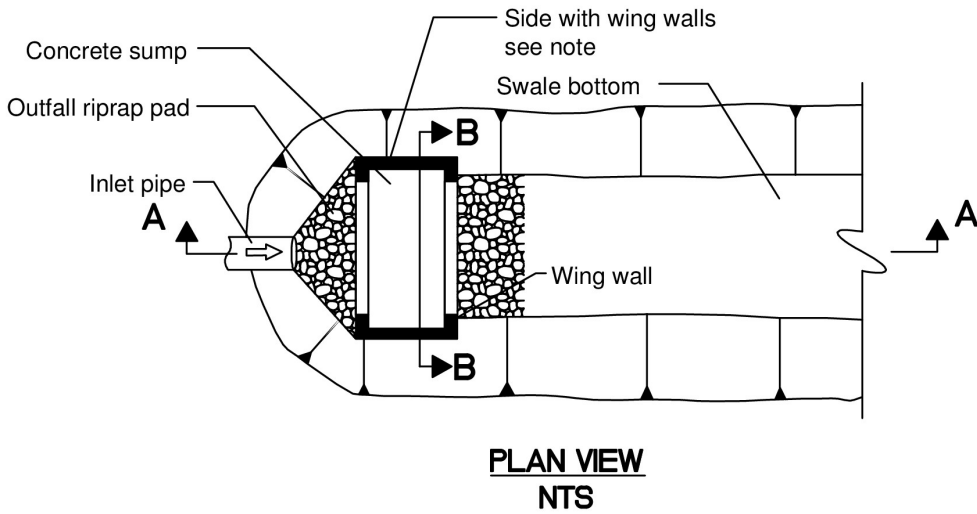


Figure 3.4: Flow Spreader Option 2 - Anchored Plate

Example of a concrete sump flow spreader used with a biofiltration swale (may be used with other WQ facilities).



**Note:** Extend sides into slope. Height of side wall and wing walls must be sufficient to handle the 100-year flow or the highest flow entering the facility.

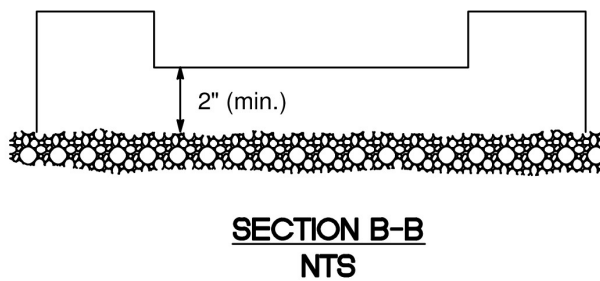


Figure 3.5: Flow Spreader Option 3 - Concrete Sump Box



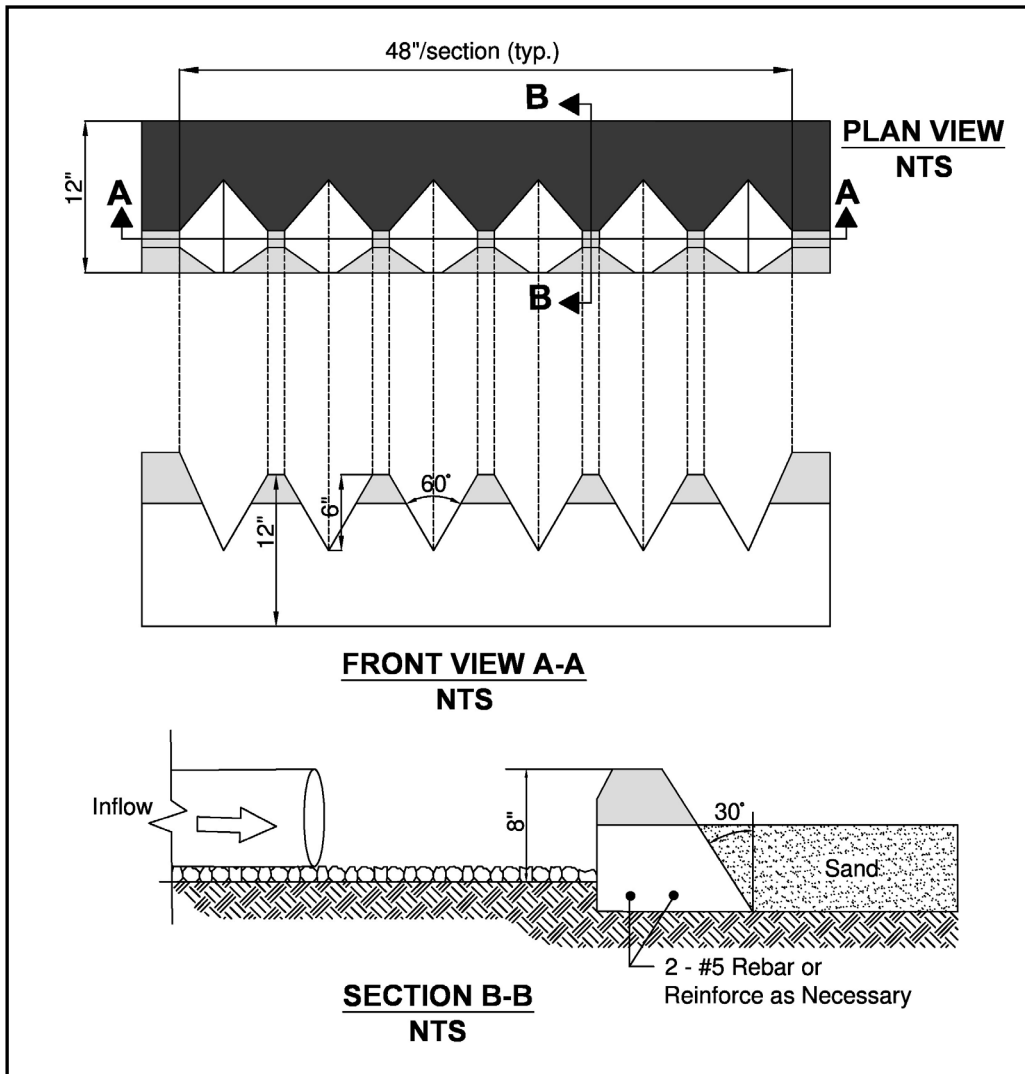


Figure 3.6: Flow Spreader Option 4 - Notched Curb Spreader

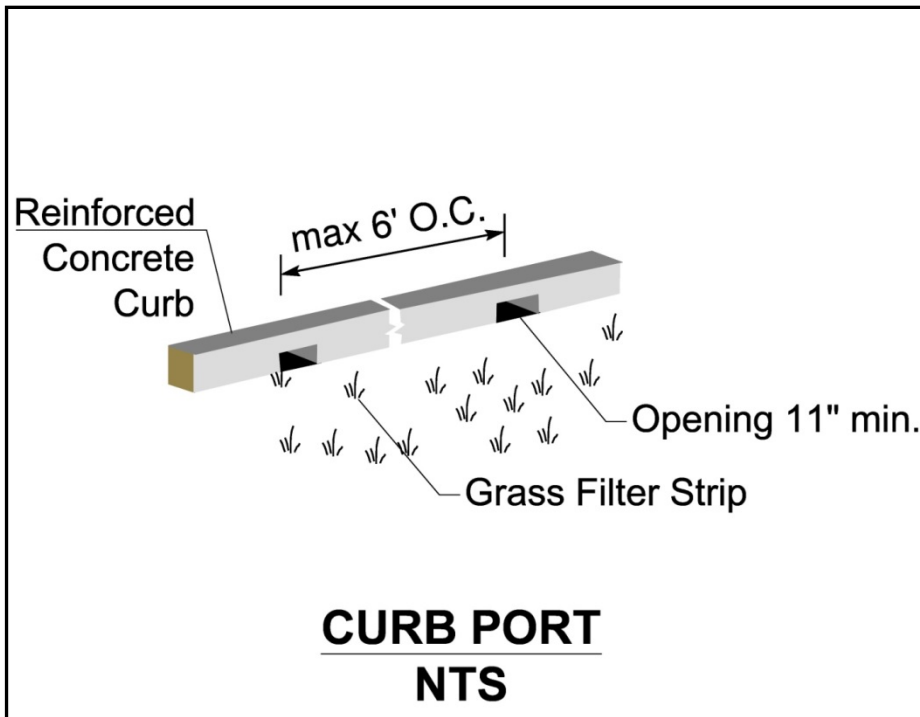


Figure 3.7: Flow Spreader Option 5 - Through-Curb Port

# Chapter 4 Runoff Treatment BMPs

## Chapter Contents

<b>BMP T6.10: Presettling Basin</b> .....	145
<b>BMP T11.10: API (Baffle type) Separator Bay</b> .....	147
<b>BMP T11.11: Coalescing Plate (CP) Separator Bay</b> .....	153
<b>BMP T8.10: Basic Sand Filter Basin</b> .....	155
<b>BMP T8.11: Large Sand Filter Basin</b> .....	166
<b>BMP T8.20: Sand Filter Vault</b> .....	168
<b>BMP T8.30: Linear Sand Filter</b> .....	172
<b>BMP T8.40: Media Filter Drain (previously “Ecology Embankment”)</b> .....	175
<b>BMP T9.10: Basic Biofiltration Swale</b> .....	188
<b>BMP T9.20: Wet Biofiltration Swale</b> .....	204
<b>BMP T9.30: Continuous Inflow Biofiltration Swale</b> .....	208
<b>BMP T9.40: Basic Filter Strip</b> .....	210
<b>BMP T7.40: Compost-Amended Vegetated Filter Strips (CAVFS)</b> .....	213
<b>BMP T10.10: Wetponds - Basic and Large</b> .....	217
<b>BMP T10.20: Wetvault</b> .....	229
<b>BMP T10.30: Stormwater Treatment Wetlands</b> .....	236
<b>Proprietary BMP: StormFilter®</b> .....	246
<b>Proprietary BMP: Filterra®</b> .....	246
<b>Proprietary BMP: Perk Filter™</b> .....	246

## Chapter Figures

Figure 4.1: API (Baffle Type) Separator.....	151
Figure 4.2: Ratio of SBUH Peak/WQ Flow for On-Line .....	152
Figure 4.3: Ratio of SBUH Peak/WQ Flow for Off-Line.....	152
Figure 4.4: Sand Filter schematic on-line .....	157
Figure 4.5: Sand Filter - Schematic of Off-line Upstream Placement.....	158
Figure 4.6: Sand Filter Schematic Off-line Downstream.....	158
Figure 4.7: Sand Filter with Pretreatment Cell – Plan View.....	163
Figure 4.8: Sand Filter with Pretreatment Cell - Section View .....	164
Figure 4.9: Sand Filter with Flow Spreader – Plan View .....	164

Figure 4.10: Sand Filter with Flow Spreader - Plan View .....	165
Figure 4.11: Sand Filter Vault Plan View.....	170
Figure 4.12: Sand Filter Vault.....	171
Figure 4.13: Linear Sand Filter .....	174
Figure 4.14: Media Filter Drain, Cross-section.....	178
Figure 4.15: Dual Media Filter Drain, Cross-section.....	179
Figure 4.16: Media Filter Drain without underdrain trench .....	180
Figure 4.17: Typical Swale Section .....	188
Figure 4.18: Biofiltration Swale Underdrain Detail.....	190
Figure 4.19: Biofiltration Swale Low-Flow Drain Detail .....	192
Figure 4.20: Swale Dividing Berm .....	193
Figure 4.21: Geometric Formulas for Common Swale Shapes.....	195
Figure 4.22: Relationship of Manning’s n with VR.....	200
Figure 4.23: Typical Filter Strip.....	210
Figure 4.24: Compost-amended Vegetated Filter Strip Photo .....	214
Figure 4.25: Compost Amended Vegetated Filter Strip Typical.....	216
Figure 4.26: Wetpond - Plan View .....	219
Figure 4.27: Wetpond - Section View .....	220
Figure 4.28: Wetvault.....	231
Figure 4.29: Stormwater Wetland - Option 1 .....	240
Figure 4.30: Stormwater Wetland - Option 2 .....	241

## Chapter Tables

Table 4.1: Sand Medium Specification.....	160
Table 4.2: Clay Liner Specifications .....	161
Table 4.3: Design Widths for Media Filter Drains.....	183
Table 4.4: Media Filter Drain Mix .....	186
Table 4.5: Biofiltration Swale Sizing Criteria .....	191
Table 4.6: Guide for Selecting Degree of Retardance .....	199
Table 4.7: Grass Seed Mixes Suitable for Biofiltration Swale Treatment Areas.....	202
Table 4.8: Groundcovers and Grasses Suitable for Upper Side Slopes of a Swale.....	203
Table 4.9: Acceptable Plants for Wet Biofiltration Swale.....	207
Table 4.10: Filter Strip Sizing Criteria.....	212
Table 4.11: Emergent Wetland Plant Species Acceptable for Wetponds.....	227
Table 4.12: Distribution of Depths in Wetland Cell.....	239
Table 4.13: Acceptable Plants for Treatment Wetlands .....	243

## BMP T6.10: Presettling Basin

---

### Purpose and Description

A Presettling Basin provides pretreatment of runoff in order to remove suspended solids, which can impact other runoff treatment BMPs.

### Cross Reference Guide

Soils Assessment	None
Minimum Requirements/ Treatment Type	MR #6 Oil Control
Related BMPs	None.
Selection/Infeasibility Criteria	<a href="#">Book 1, Section 3.2 and Section 3.4.1</a>
Maintenance	<a href="#">Book 4</a>

### Application, Limitations and Setbacks

- Runoff treated by a Presettling Basin may not be discharged directly to a receiving water; it must be further treated by a basic or enhanced runoff treatment BMP.
- All facilities shall be a minimum of 20 feet from any structure, property line, and critical area buffer.
- All facilities shall be 100 feet from any septic tank/drainfield (except wet vaults shall be a minimum of 20 feet).
- All facilities shall be a minimum of 50 feet from any steep (greater than 15 percent) slope. A geotechnical report must address the potential impact of a wet pond on a steep slope.
- Embankments that impound water must comply with the Washington State Dam Safety Regulations ([Chapter 173-175 WAC](#)). If the impoundment has a storage capacity (including both water and sediment storage volumes) greater than 10 acre-feet (435,600 cubic feet or 3.26 million gallons) above natural ground level, then dam safety design and review are required by Ecology.

### Setbacks

See [Section 3.1.4](#).

### Design Criteria

1. A Presettling Basin shall be designed with a wetpool. The treatment volume shall be at least 30 percent of the total volume of runoff from the 6-month, 24-hour storm event.

2. If the runoff in the Presettling Basin will be in direct contact with the soil, it must be lined per the liner requirement in [Section 3.1.6](#).
  3. The Presettling Basin shall conform to the following:
    - The length-to-width ratio shall be at least 3:1. Berms or baffles may be used to lengthen the flow path.
    - The minimum depth shall be 4 feet; the maximum depth shall be 6 feet.
  4. Inlets and outlets shall be designed to minimize velocity and reduce turbulence. Inlet and outlet structures should be located at extreme ends of the basin in order to maximize particle-settling opportunities.
  5. Inlets and outlets shall be designed to minimize velocity and reduce turbulence. Inlet and outlet structures should be located at extreme ends of the basin in order to maximize particle-settling opportunities.
- For information on allowable side slopes, see [Section 3.1.4](#).
  - For information on fencing, see [BMP D6.10 Detention Ponds](#) in [Section 6.2](#).

## BMP T11.10: API (Baffle type) Separator Bay

---

### Purpose and Description

To remove oil and other water-insoluble hydrocarbons, and settleable solids from stormwater runoff.

### Cross Reference Guide

Soils Assessment	None
Minimum Requirements/ Treatment Type	MR #6 Oil Control
Related BMPs	None.
Selection/Infeasibility Criteria	<a href="#">Book 1, Section 3.2 and Section 3.4.1</a>
Maintenance	<a href="#">Book 4</a>

### Applications, Limitations and Setbacks

The following are potential applications of oil and water separators where free oil is expected to be present at treatable high concentrations and sediment will not overwhelm the separator. (Seattle METRO, 1990; Watershed Protection Techniques, 1994; King County Surface Water Management, 1998) For low concentrations of oil, other treatments may be more applicable. These include sand filters and emerging technologies.

- Commercial and industrial areas including petroleum storage yards, vehicle maintenance facilities, manufacturing areas, airports, utility areas (water, electric, gas), and fueling stations. (King County Surface Water Management, 1998)
- Facilities that would require oil control BMPs under the high-use site threshold described in [Book 1, Section 3.2.1](#) including parking lots at convenience stores, fast food restaurants, grocery stores, shopping malls, discount warehouse stores, banks, truck fleets, auto and truck dealerships, and delivery services. (King County Surface Water Management, 1998)
- Without intense maintenance oil/water separators may not be sufficiently effective in achieving oil and TPH removal down to required levels. For inflows from small drainage areas (fueling stations, maintenance shops, etc.) coalescing plate (CP) type separator is typically considered, due to space limitations. However, if plugging of the plates is likely, then a new design basis for the baffle type API separator may be considered on an experimental basis in accordance with emerging technology requirements.

Consider the following characteristics:

- Sufficient land area

- Adequate TSS control or pretreatment capability
- Compliance with environmental objectives
- Adequate influent flow attenuation and/or bypass capability
- Sufficient access for operation and maintenance (O&M)

## Setbacks

See [Section 3.1.4](#).

## Design Criteria

Pretreatment should be considered if the level of TSS in the inlet flow would cause clogging or otherwise impair the long-term efficiency of the separator.

The criteria for sizing the API Separator Bay is based on  $V_h$ ,  $V_r$ , residence time, width, depth, and length considerations. As a correction factor, API's turbulence criteria is applied to increase the length.

The following is the sizing procedure using modified API criteria:

- Determine the oil rise rate,  $V_r$ , in cm/sec, using Stokes Law (Water Pollution Control Federation, 1985), or empirical determination, or 0.033 ft./min for 60 $\mu$  oil. The application of Stokes' Law to site-based oil droplet sizes and densities, or empirical rise rate determinations recognizes the need to consider actual site conditions. In those cases the design basis would not be the 60 micron droplet size and the 0.033 ft/min. rise rate.
- Stokes Law equation for rise rate,  $V_t$  (cm/sec):

$$V_t = [(g)(\rho_w - \rho_o)(d^2)] / [(18*\mu_w)]$$

Where:

- $V_t$  = the rise rate of the oil droplet (cm/s or ft/sec)
- $g$  = acceleration due to gravity (cm/s<sup>2</sup> or ft/s<sup>2</sup>)
- $\rho_w$  = density of water at the design temperature (g/cm<sup>3</sup> or lbm/ft<sup>3</sup>)
- $\rho_o$  = density of oil at the design temperature (g/cm<sup>3</sup> or lbm/ft<sup>3</sup>)
- $d$  = oil droplet diameter (cm or ft)
- $\mu_w$  = absolute viscosity of the water (g/cms or lbm/fts)

Use the following separator dimension criteria:

- Separator water depth,  $d \geq 3 \leq 8$  feet (to minimize turbulence) (American Petroleum Institute, 1990; US Army Corps of Engineers, 1994).



- Separator width, 6-20 feet (WEF & ASCE, 1998; King County Surface Water Management, 1998)
- Depth/width (d/w) of 0.3-0.5 (American Petroleum Institute, 1990)

**For Stormwater Inflow from Drainages under 2 Acres**

1. Determine  $V_t$  and select depth and width of the separator section based on above criteria.
2. Calculate the minimum residence time ( $t_m$ ) of the separator at depth d:

$$t_m = d/V_t$$

3. Calculate the horizontal velocity of the bulk fluid,  $V_h$ , vertical cross-sectional area,  $A_v$ , and actual design  $V_h/V_t$  (American Petroleum Institute, 1990; US Army Corps of Engineers, 1994).

$$V_h = Q/dw = Q/A_v \text{ (} V_h \text{ maximum at } < 2.0 \text{ ft/min.) (American Petroleum Institute, 1990)}$$

$Q = (k)$  the ratio indicated in [Figure 4.2](#), for an on-line facility, or [Figure 4.3](#), for an off-line facility, for the site location multiplied by the 15-minute Water Quality design flow rate in  $\text{ft}^3/\text{min}$ , at minimum residence time,  $t_m$

At  $V_h/V_t$  determine  $F$ , turbulence and short-circuiting factor (see [Appendix 2-F](#)) API  $F$  factors range from 1.28-1.74. (American Petroleum Institute, 1990)

4. Calculate the minimum length of the separator section,  $l(s)$ , using:

$$l(s) = FQt_m/wd = F(V_h/V_t)d$$

$$l(t) = l(f) + l(s) + l(a)$$

$$l(t) = l(t)/3 + l(s) + l(t)/4$$

where:

- $l(t)$  = total length of 3 bays = “L” in [Figure 4.1](#)
- $l(f)$  = length of forebay
- $l(a)$  = length of afterbay

5. Calculate  $V = l(s)wd = FQt_m$ , and  $A_h = wl(s)$

$V$  = minimum hydraulic design volume  
 $A_h$  = minimum horizontal area of the separator

**For Stormwater Inflow from Drainages > 2 Acres**

Use  $V_h = 15 V_t$  and  $d = (Q/2V_h)^{1/2}$  (with  $d/w = 0.5$ ) and repeat above calculations 3 through 5.

**Criteria for Separator Bays**

- Size the separator bay for the Water Quality design flow rate (15 minute time step) x a correction factor ratio indicated in [Figure 4.3](#)(assuming an off-line facility).

- To collect floatables and settleable solids, design the surface area of the forebay at  $\geq 20 \text{ ft}^2$  per 10,000  $\text{ft}^2$  of area draining to the separator <sup>(6)</sup>. The length of the forebay should be 1/3-1/2 of the length of the entire separator. Include roughing screens for the forebay or upstream of the separator to remove debris, if needed. Screen openings should be about 3/4 inch.
- Include a submerged inlet pipe with a turn-down elbow in the first bay at least two feet from the bottom. The outlet pipe should be a Tee, sized to pass the design peak flow and placed at least 12 inches below the water surface.
- Include a shutoff mechanism at the separator outlet pipe. (King County Surface Water Management, 1998)
- Use absorbents and/or skimmers in the afterbay as needed.

### Criteria for Baffles

- Oil retaining baffles (top baffles) should be located at least at 1/4 of the total separator length from the outlet and should extend down at least 50% of the water depth and at least 1 ft. from the separator bottom.
- Baffle height to water depth ratios should be 0.85 for top baffles and 0.15 for bottom baffles.

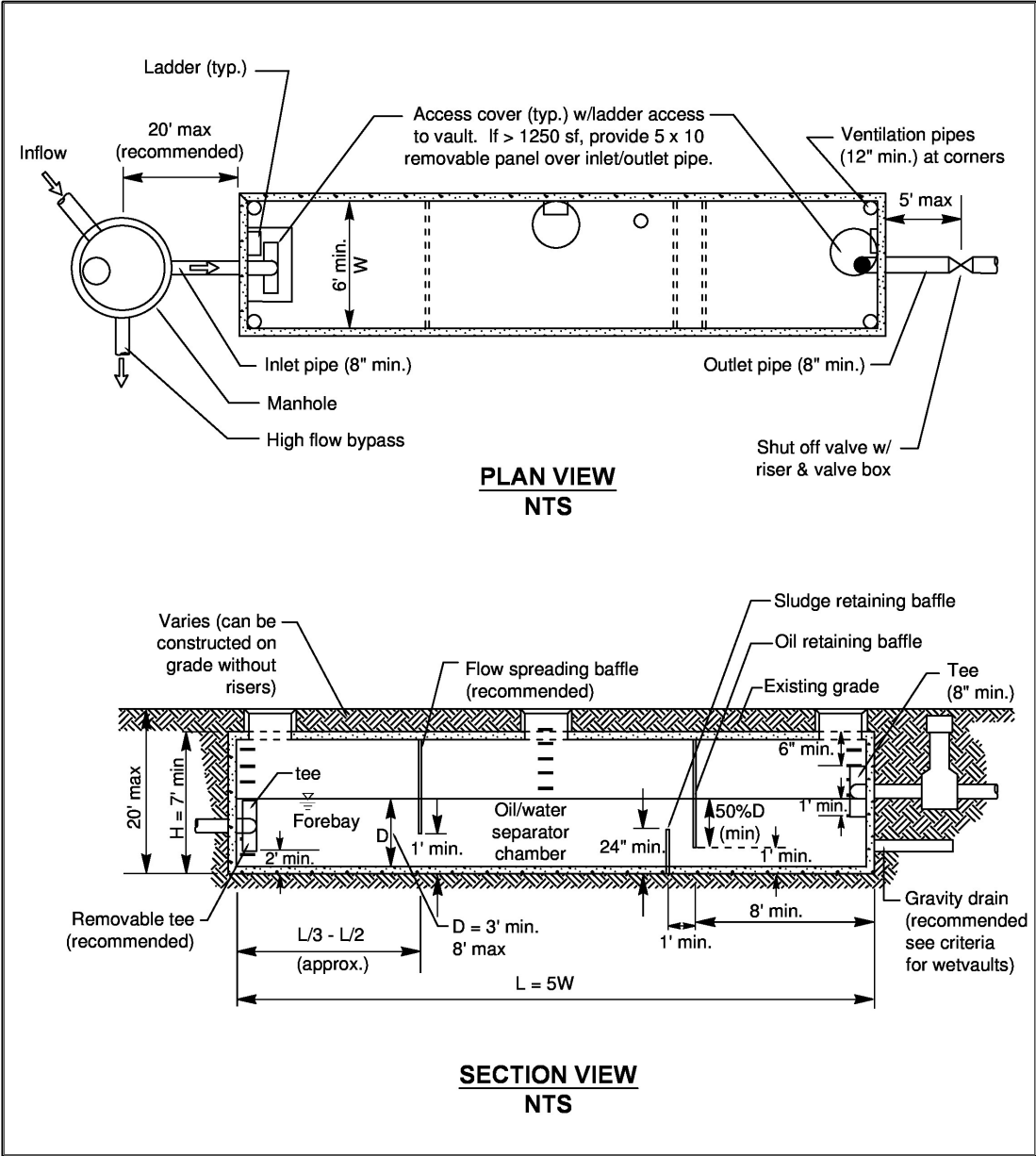


Figure 4.1: API (Baffle Type) Separator

(Note: Hinged locking doors are to be provided for all access locations to this vault)

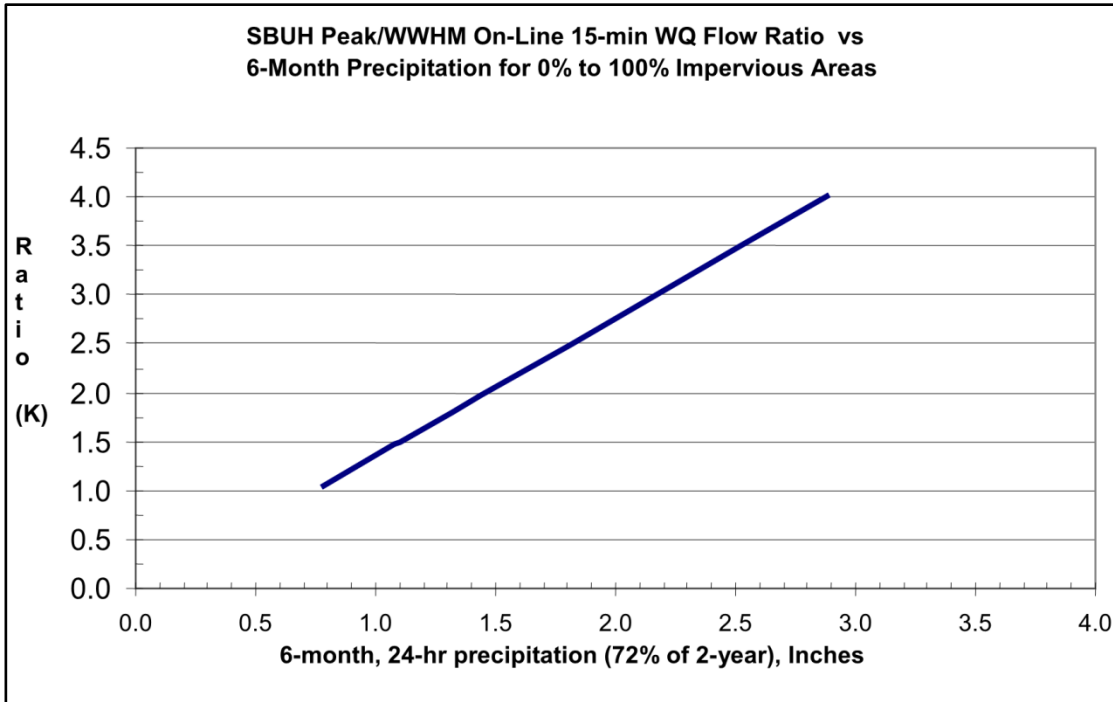


Figure 4.2: Ratio of SBUH Peak/WQ Flow for On-Line

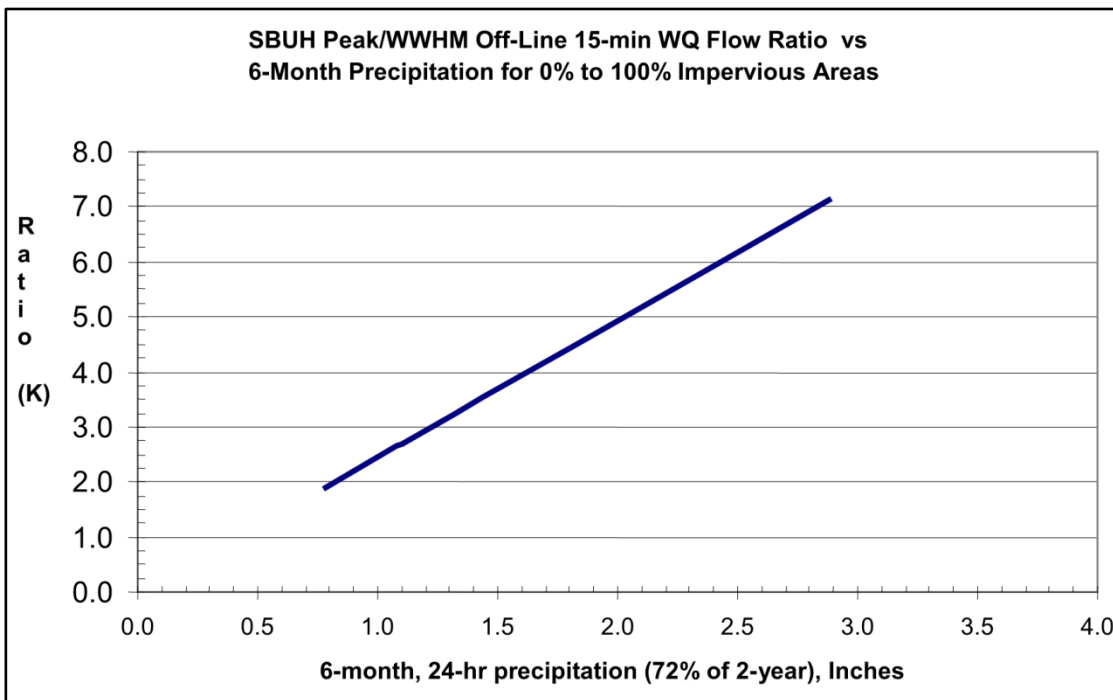


Figure 4.3: Ratio of SBUH Peak/WQ Flow for Off-Line

## BMP T11.11: Coalescing Plate (CP) Separator Bay

---

For Purpose and Description, Cross Reference, and Application, Limitations and Setbacks see [BMP T11.10](#).

### Setbacks

See [Section 3.1.4](#).

### Design Criteria

Calculate the projected (horizontal) surface area of plates needed using the following equation:

$$A_h = Q/V_t = [Q] / [(.00386) * ((S_w - S_o)/(\mu_w))]$$

Where:

- $A_h$  = horizontal surface area of the plates (ft<sup>2</sup>)
- $V_t$  = rise rate of the oil droplet (ft/min)
- $Q$  = (k) the ratio indicated in [Figure 4.2](#) (for on-line facilities) or [Figure 4.3](#) (for off-line facilities) for the site location multiplied by the 15-minute Water Quality design flow rate in ft<sup>3</sup>/min, at minimum residence time,  $t_m$
- $S_w$  = specific gravity of water at the design temperature
- $S_o$  = specific gravity of oil at the design temperature
- $\mu_w$  = absolute viscosity of the water (poise)

The above equation is based on an oil droplet diameter of 60 microns.

- Plate spacing should be a minimum of 3/4 in (perpendicular distance between plates) or as determined by the manufacturer. (WEF & ASCE, 1998; US Army Corps of Engineers, 1994; US Air Force, 1991; Jaisinghani, R., 1979)
- Select a plate angle between 45° to 60° from the horizontal.
- Locate plate pack at least 6 inches from the bottom of the separator for sediment storage.
- Add 12 inches minimum head space from the top of the plate pack and the bottom of the vault cover.
- Design inlet flow distribution and baffles in the separator bay to minimize turbulence, short-circuiting, and channeling of the inflow especially through and around the plate packs of the CP separator. The Reynolds Number through the separator bay should be <500 (laminar flow).
- Include forebay for floatables and afterbay for collection of effluent. (WEF & ASCE, 1998)
- The sediment-retaining baffle must be upstream of the plate pack at a minimum height of 18 in. (King County Surface Water Management, 1998).

- Design plates for ease of removal, and cleaning with high-pressure rinse or equivalent.

## BMP T8.10: Basic Sand Filter Basin

---

### Purpose and Description

A sand filter basin is constructed so that its surface is at grade and open to the elements, much as an infiltration basin. However, instead of infiltrating into native soils, stormwater filters through a constructed sand bed with an underdrain system. A typical sand filtration system consists of a pretreatment system, flow spreader(s), sand bed, and underdrain piping. The sand filter bed includes a geotextile fabric between the sand bed and the bottom underdrain system.

The variations of a sand filter include a basic sand filter basin, large sand filter basin, sand filter vault, and linear sand filter. (Figures throughout this chapter provide examples of various sand filter configurations.)

### Cross Reference Guide

Soils Assessment	None
Minimum Requirements/ Treatment Type	MR #6 Basic when preceded by a pretreatment BMP Phosphorus, or Enhanced as part of a treatment train
Related BMPs	<a href="#">BMP T6.10</a> for pretreatment Enhanced or Phosphorus treatment train: <a href="#">BMP T8.40</a> , <a href="#">BMPs T9.10</a> , <a href="#">T9.20</a> , <a href="#">T9.30</a> , <a href="#">BMPs T10.10</a> , <a href="#">T10.20</a> , or <a href="#">D6.40</a> Phosphorus only treatment train: <a href="#">BMP T10.30</a> .
Selection/Infeasibility Criteria	<a href="#">Book 1, Section 3.2 and Section 3.4.2</a>
Maintenance	<a href="#">Book 4</a>

### Applications, Limitations, and Setbacks

Filtration can be used in most residential, commercial, and industrial developments where debris, heavy sediment loads, and oils and greases will not clog or prematurely overload the sand, or where adequate pretreatment is provided for these pollutants. Specific applications include residential subdivisions, parking lots for commercial and industrial establishments, gas stations, high-use sites, high-density multi-family housing, roadways, and bridge decks.

Locate sand filters off-line before or after detention (Chang, 2000). Sand filters are also suited for locations with space constraints in retrofit and new/re-development situations. Carefully design overflow or bypass structures to handle the larger storms. Size off-line systems to treat 91% of the

runoff volume predicted by an approved continuous flow model. If a project must comply with Minimum Requirement #7, Flow Control, route the flows bypassing the filter and the filter discharge to a retention/detention facility.

Only locate on-line sand filters downstream of detention to prevent exposure of the sand filter surface to high flow rates that could cause loss of media and previously removed pollutants.

Pretreatment is necessary to reduce velocities to the sand filter and remove debris, floatables, large particulate matter, and oils. In high water table areas, adequate drainage of the sand filter may require additional engineering analysis and design considerations. Consider an underground filter in areas subject to freezing conditions (Urbonas, 1997).

## Setbacks

See [Section 3.1.4](#).

## Design Criteria

### Hydraulics

Use a sand filter basin to capture and treat the Water Quality Design Storm volume, which is 91% of the total runoff volume as predicted by an approved continuous flow model. Only 9% of the total runoff volume should bypass or overflow from the sand filter facility.

If the drainage area maintains a base flow between storm events, base flow must be bypassed around the filter to keep the sand from remaining saturated for extended periods.

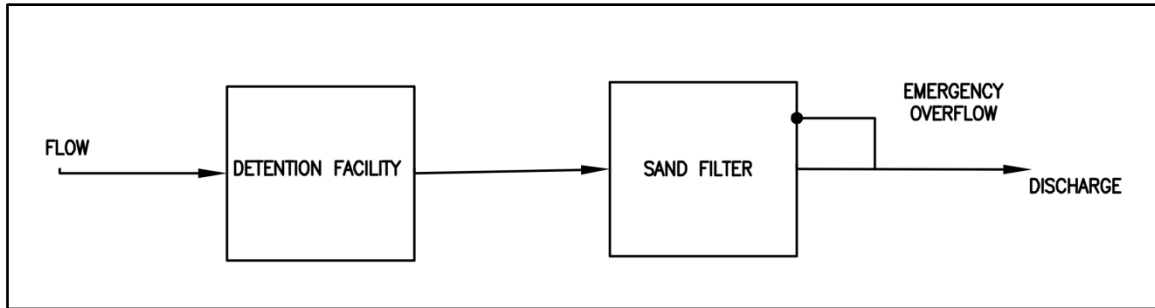
Assume a design filtration rate of 1 inch per hour. Though the sand specified below will initially infiltrate at a much higher rate, that rate will slow as the filter accumulates sediment. When the filtration rate falls to 1 inch per hour, removal of sediment is necessary to maintain rates above the rate assumed for sizing purposes.

### Site Characteristics

#### On-line

- Do not place upstream of a detention facility. Exposure of the sand filter surface to high flow rates could cause loss of media and previously removed pollutants.
- Size on-line sand filters placed downstream of a detention facility using an approved continuous flow model to filter the water quality runoff volume.
- Include an overflow in the design. The overflow height must be at the maximum hydraulic head of the pond above the sand bed. On-line filters shall have overflows (primary, secondary, and emergency) in accordance with the design criteria for detention ponds (see [Section 6.2](#)).





**Figure 4.4: Sand Filter schematic on-line**

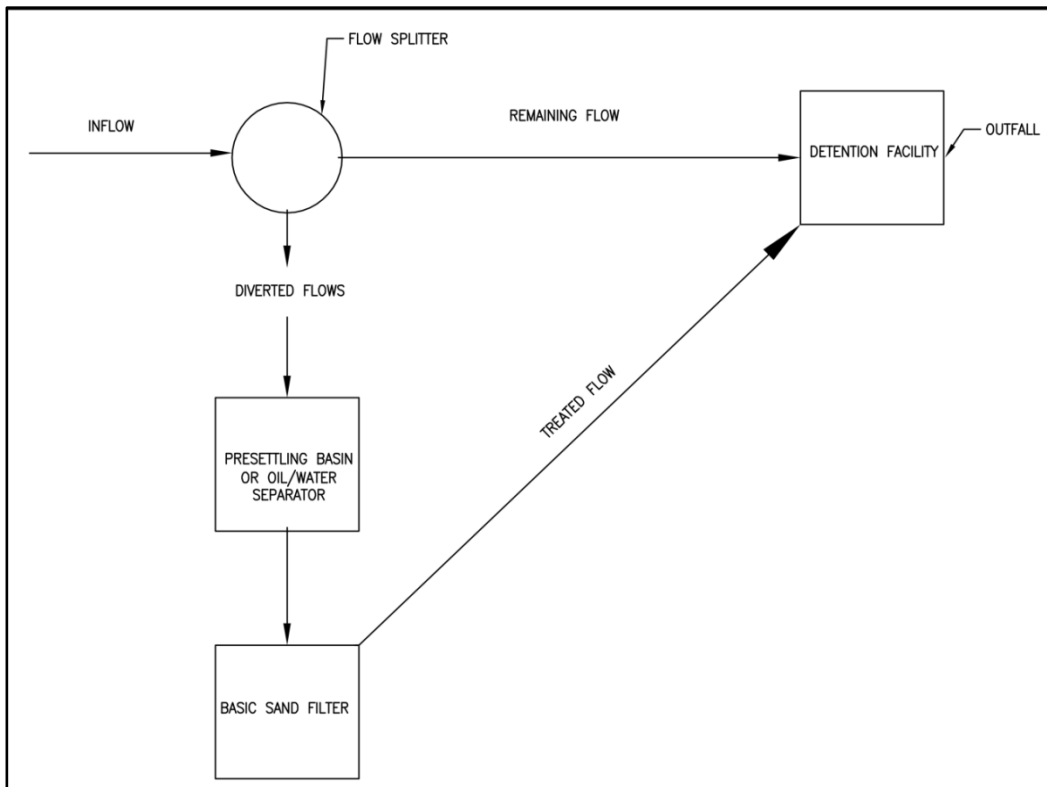
(Source: Clark County)

#### Off-line

- For off-line filters, design the underdrain structure to pass the 2-year peak inflow rate, as determined using 15-minute time steps in an approved continuous flow model.

#### *Off-line Located Upstream*

- Off-line sand filters placed upstream of a detention facility must have a flow splitter designed to send all flows at or below the 15-minute water quality flow rate, as predicted by an approved continuous flow model, to the sand filter.
- Size the facility to filter all the runoff sent to it (no overflows from the treatment facility may occur). Note that WWHM allows bypass flows and filtered runoff to be directed to the downstream detention facility.

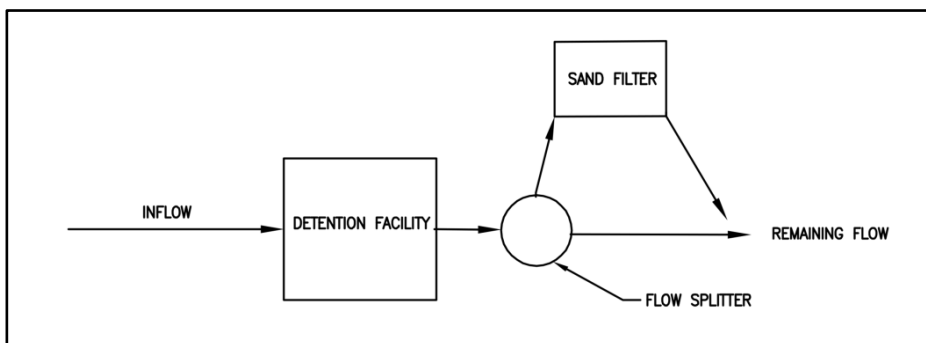


**Figure 4.5: Sand Filter - Schematic of Off-line Upstream Placement**

(Source: Clark County)

*Off-line Located Downstream*

Off-line sand filters placed downstream of a detention facility must have a flow splitter designed to send all flows at or below the 2-year flow frequency from the detention pond, as predicted by WWHM, to the treatment facility. The treatment facility must be sized to filter all the runoff sent to it (no overflows from the treatment facility should occur).



**Figure 4.6: Sand Filter Schematic Off-line Downstream**

(Source: Clark County)

### Additional Design Criteria

1. Pretreat (e.g., presettling basin, etc. depending on pollutants) runoff directed to the sand filter to remove debris and other solids. In high use sites, the pretreatment must be an appropriate oil control treatment.
2. Design inlet bypass and flow spreading structures (e.g., flow spreaders, weirs or multiple orifice openings) to capture the applicable design flow rate, minimize turbulence and to spread the flow uniformly across the surface of the sand filter. Install stone riprap or other energy dissipation devices to prevent gouging of the sand medium and to promote uniform flow. Include emergency spillway or overflow structures.
  - d. If the sand filter is curved or an irregular shape, provide a flow spreader for a minimum of 20 percent of the filter perimeter.
  - e. If the length-to-width ration of the filter is 2:1 or greater, locate a flow spreader on the longer side of the filter and for a minimum length of 20 percent of the facility perimeter.
  - f. Provide erosion protection along the first foot of the sand bed adjacent to the flow spreader. Methods for this include geotextile weighted with sand bags at 15-foot intervals and quarry spalls.
3. The following are acceptable types of underdrains:
  - g. A central collector pipe with lateral feeder pipes in an 8-inch gravel backfill or drain rock bed.
  - h. A central collector pipe with a geotextile drain strip in an 8-inch gravel backfill or drain rock bed.
  - i. Longitudinal pipes in an 8-inch gravel backfill or drain rock with a collector pipe at the outlet end.
  - j. Upstream of detention, size underdrain piping to handle double the two-year return frequency flow indicated by WWHM (the doubling factor is a safety factor used in the absence of a conversion factor from the 1-hr. time step to a 15 minute time step). Downstream of detention, size the underdrain piping for the two-year return frequency flow indicated by WWHM. In both instances provide at least one (1) foot of hydraulic head above the invert of the upstream end of the collector pipe. (King County, 1998)
  - k. Use underdrain pipe with a minimum of internal diameter of 6 inches, with 2 rows of ½-inch holes spaced 6 inches apart longitudinally (maximum), and rows 120 degrees apart (laid with holes downward). Maintain a maximum perpendicular

distance between 2 feeder pipes, or the edge of the filter and a feeder pipe, of 15 feet. For all piping use schedule 40 PVC or piping with a greater wall thickness.

- l. Slope the main collector underdrain pipe at 0.5 percent minimum. (King County, 1998)
- m. Use a geotextile fabric between the sand layer and drain rock or gravel. Cover the geotextile fabric with 1-inch of drain rock/gravel. Use 0.75-1.5 inch drain rock or gravel backfill, washed free of clay and organic material. (King County, 1998)

Place cleanout wyes with caps or junction boxes at both ends of the collector pipes. Extend cleanouts to the surface of the filter. Supply a valve box for access to the cleanouts. Provide access for cleaning all underdrain piping. This may consist of installing cleanout ports, which tee into the underdrain system and surface above the top of the sand bed. To facilitate maintenance of the sand filter an inlet shutoff/bypass valve is recommended.

Sand specification: The sand shall be 18 inches minimum in depth and must consist of a medium sand meeting the size gradation (by weight) given in [Table 4.1](#). The contractor must obtain a grain size analysis from the supplier to certify that the sand meets the No. 100 and No. 200 sieve requirements. (Note: Standard backfill for sand drains, WSDOT. Std. Spec. 9-03.13, does not meet this specification.)

**Table 4.1: Sand Medium Specification**

U.S. Sieve Number	Percent Passing
4	95-100
8	70-100
16	40-90
30	25-75
50	2-25
100	<4
200	<2

Source: King County Surface Water Design Manual

- 4. Impermeable Liners for Sand Bed Bottom: impermeable liners are required for soluble pollutants such as metals and toxic organics and where the underflow could cause problems with structures. Impermeable liners may consist of clay, concrete or geomembrane. Clay liners should have a minimum thickness of 12 inches and meet the specifications give in [Table 4.2](#).

**Table 4.2: Clay Liner Specifications**

Property	Test Method	Unit	Specification
Permeability	ASTM D-2434	cm/sec	$1 \times 10^{-6}$ max.
Plasticity Index of Clay	ASTM D-423 & D-424	percent	Not less than 15
Liquid Limit of Clay	ASTM D-2216	percent	Not less than 30
Clay Particles Passing	ASTM D-422	percent	Not less than 30
Clay Compaction	ASTM D-2216	percent	95% of Standard Proctor Density

Source: City of Austin, 1988

- If a geomembrane liner is used it should have a minimum thickness of 30 mils and be ultraviolet resistant. Protect the geomembrane liner from puncture, tearing, and abrasion by installing geotextile fabric on the top and bottom of the geomembrane.
  - Concrete liners may also be used for sedimentation chambers and for sedimentation and sand filtration basins less than 1,000 square feet in area. Concrete should be 5 inches thick Class A or better and reinforced by steel wire mesh. The steel wire mesh should be 6 gauge wire or larger and 6-inch by 6-inch mesh or smaller. An "Ordinary Surface Finish" is required. When the underlying soil is clay or has an unconfined compressive strength of 0.25 ton per square foot or less, the concrete should have a minimum 6-inch compacted aggregate base. This base must consist of coarse sand and river stone, crushed stone or equivalent with diameter of 0.75- to 1-inch.
  - If an impermeable liner is not required, install a geotextile fabric liner that retains the sand unless the basin has been excavated to bedrock.
  - If an impermeable liner is not provided, then an analysis should be made of possible adverse effects of seepage zones on groundwater, and near building foundations, basements, roads, parking lots and sloping sites. Sand filters without impermeable liners should not be built on fill sites and should be located at least 20-foot downslope and 100-foot upslope from building foundations.
5. High groundwater may damage underground structures or affect the performance of filter underdrain systems. There must be sufficient clearance (at least 2 feet is recommended) between the seasonal high groundwater level (highest level of groundwater observed) and the bottom of the sand filter to obtain adequate drainage.

6. Include an access ramp with a slope not to exceed 7:1, or equivalent, for maintenance purposes at the inlet and the outlet of a surface filter. Consider an access port for inspection and maintenance
7. Side slopes for earthen/grass embankments should not exceed 3:1 to facilitate mowing. For information on allowable side slopes, see [Section 3.1.4](#).

## Construction Criteria

No runoff is allowed to enter the sand filter prior to completion of construction and approval of site stabilization by the responsible inspector. Construction runoff may be routed to a pretreatment sedimentation facility, but discharge from sedimentation facilities must by-pass downstream sand filters. Careful level placement of the sand is necessary to avoid formation of voids within the sand that could lead to short-circuiting, (particularly around penetrations for underdrain cleanouts) and to prevent damage to the underlying geomembranes and underdrain system. Over-compaction should be avoided to ensure adequate filtration capacity. Sand is best placed with a low ground pressure bulldozer (4 psig or less). After the sand layer is placed water settling is recommended. Flood the sand with 10-15 gallons of water per cubic foot of sand.

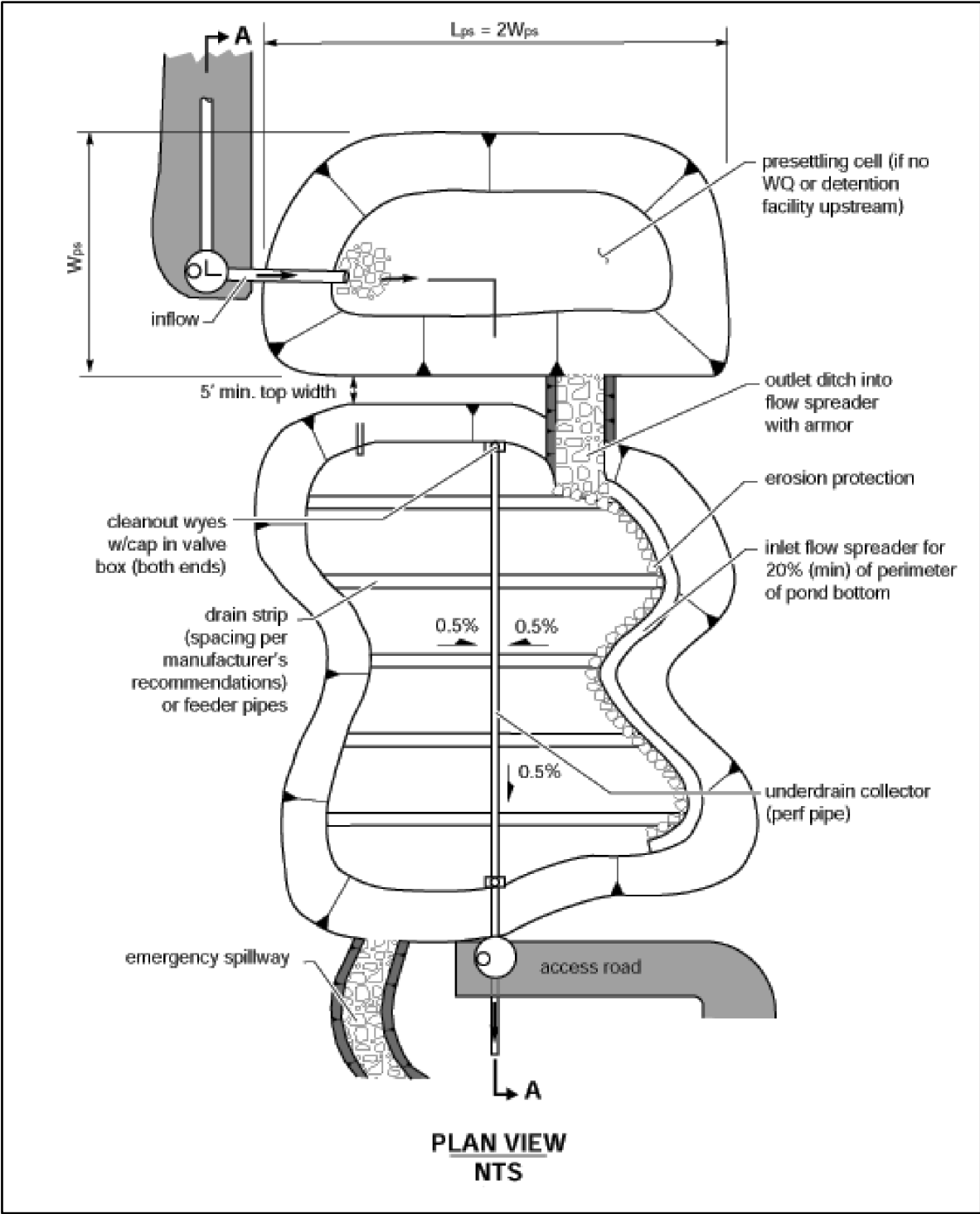
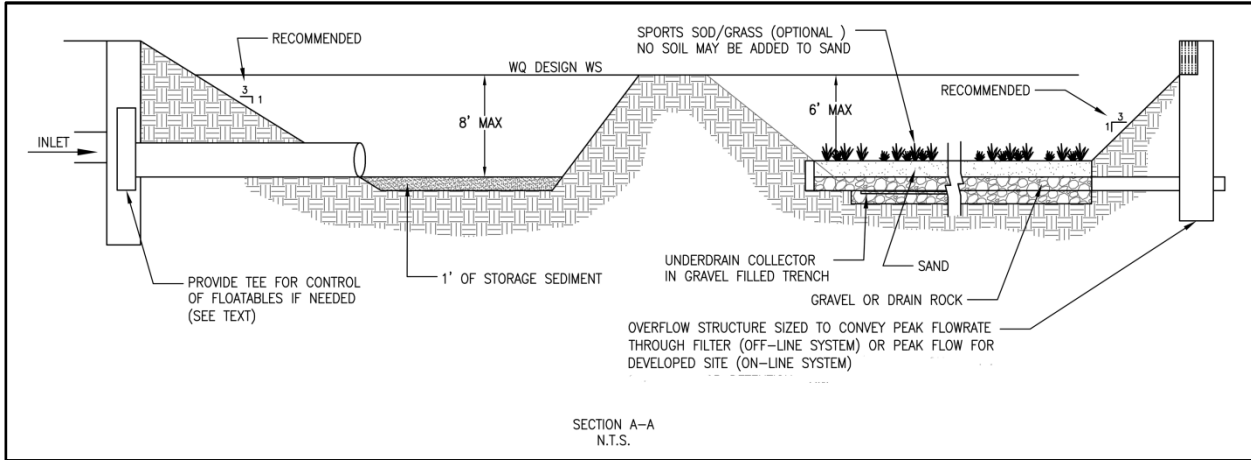


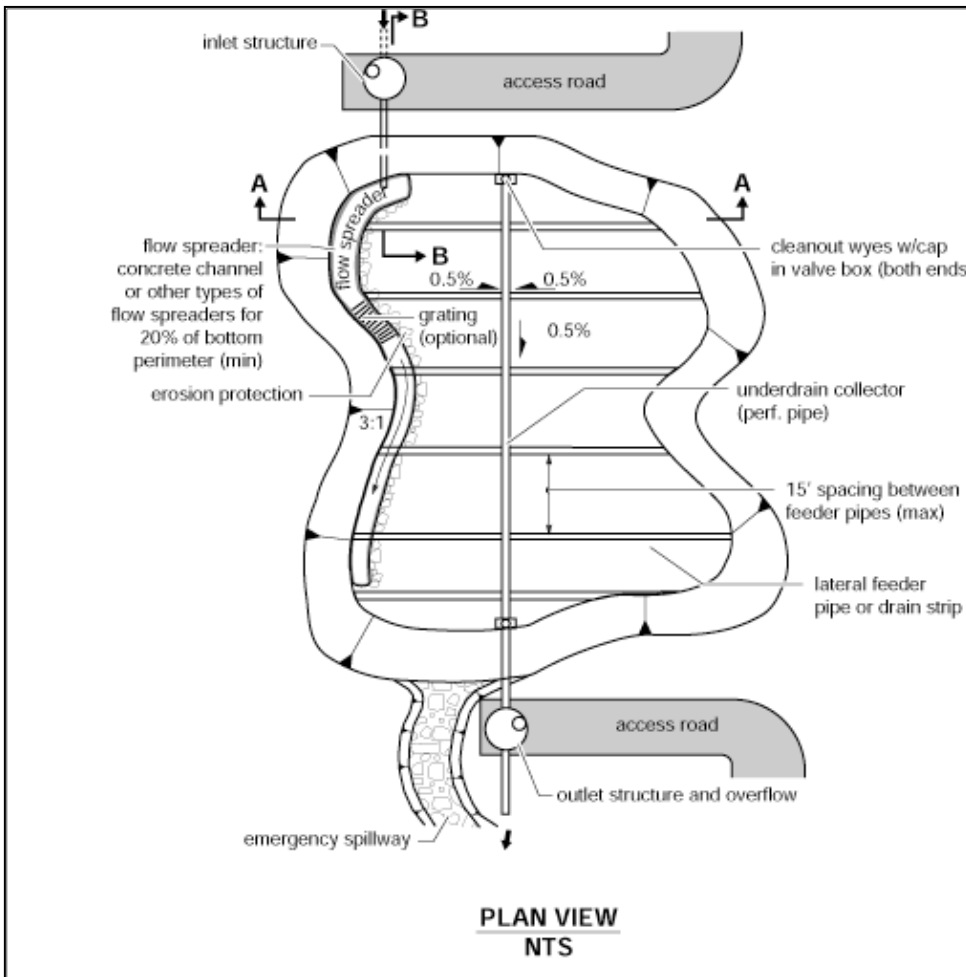
Figure 4.7: Sand Filter with Pretreatment Cell – Plan View

(Source: Department of Ecology)



**Figure 4.8: Sand Filter with Pretreatment Cell - Section View**

(Source: redrawn from Department of Ecology)



**Figure 4.9: Sand Filter with Flow Spreader – Plan View**

(Source: Department of Ecology)



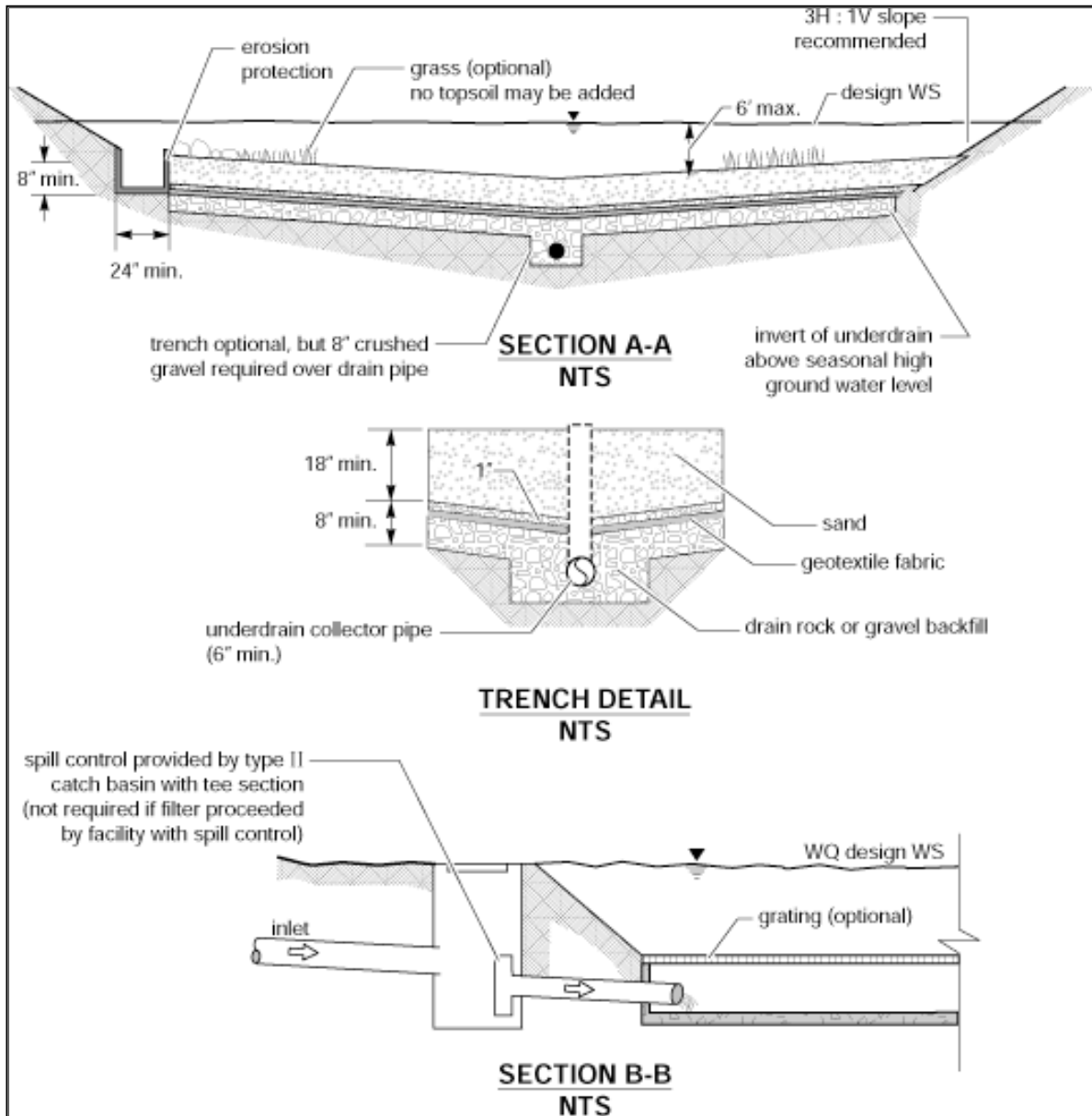


Figure 4.10: Sand Filter with Flow Spreader - ~~Plan~~ Section View

(Source: Department of Ecology)

## BMP T8.11: Large Sand Filter Basin

---

### Purpose and Description

A Large Sand Filter Basin is nearly identical to a Basic Sand Filter Basin except that it is sized to provide a higher level of treatment and is approved for use in Enhanced Treatment (See [Book 1, Section 3.2.3.5](#)).

### Cross Reference Guide

Soils Assessment	None
Minimum Requirements/ Treatment Type	MR #6 Basic or Enhanced
Related BMPs	<a href="#">BMP T6.10</a> for pretreatment
Selection/Infeasibility Criteria	<a href="#">Book 1, Section 3.2 and Section 3.4.2</a>
Maintenance	<a href="#">Book 4</a>

### Applications, Limitations, and Setbacks

Refer to [BMP T8.10](#) Basic Sand Filter Basin

### Design Criteria

The Large Sand Filter Basin captures 95% of the Water Quality Design Storm volume as predicted by WWHM. Only 5% of the total runoff volume would bypass or overflow from the facility.

### Site Characteristics

Consider the following site characteristics when siting a large sand filtration system:

- Space availability, including room for a presettling basin
- Sufficient hydraulic head, at least 4 feet from inlet to outlet
- Adequate Operation and Maintenance capability including required access for O & M
- Pretreatment requirements for oil, debris and solids in the tributary runoff
- Locate off-line sand filters either upstream or downstream of detention facilities. Only locate on-line sand filters downstream of detention to prevent exposure of the sand filter surface to high flow rates that could cause loss of media and previously removed pollutants.

## Design Volume

Size the facility to capture the Water Quality Design Volume, which is 95% of the runoff volume for the Large Sand Filter Basin (as opposed to the 91% for the Basic Sand Filter Basin).

## Overflow and Underdrains

The design flows for the overflow and underdrains must be increased from [BMP T8.10](#) Basic Sand Filter Basin to this BMP for the Large Sand Filter Basin. The overflow and underdrain design flow can be calculated by increasing the 2 year return interval peak flow by the ration of the 95% runoff volume (water quality design volume for this BMP, Large Sand Filter) and the 91% runoff volume (water quality design volume for [BMP T8.10](#) Basic Sand Filter Basin). In equation form:

Design Flow rate for Large Sand Filter Overflow or Underdrain = (95% runoff volume)/(91% runoff Volume) \* 2 year return interval peak flow.

For all other design criteria refer to [BMP T8.10](#) Basic Sand Filter Basin.

## BMP T8.20: Sand Filter Vault

---

### Purpose and Description

A sand filter vault is similar to an open sand filter except that the sand layer and underdrains are installed below grade in a vault. It consists of presettling and sand filtration cells.

### Cross Reference Guide

Refer to [BMP T8.10](#) Basic Sand Filter Basin

### Applications, Limitations, and Setbacks

Refer to [BMP T8.10](#) Basic Sand Filter Basin

### Design Criteria

See design criteria for sand filter basins, including: hydraulics and additional criteria.

### Site Characteristics

- Use where space limitations preclude above ground facilities
- Not suitable where high water table and heavy sediment loads are expected
- An elevation difference of 4 feet between inlet and outlet is needed

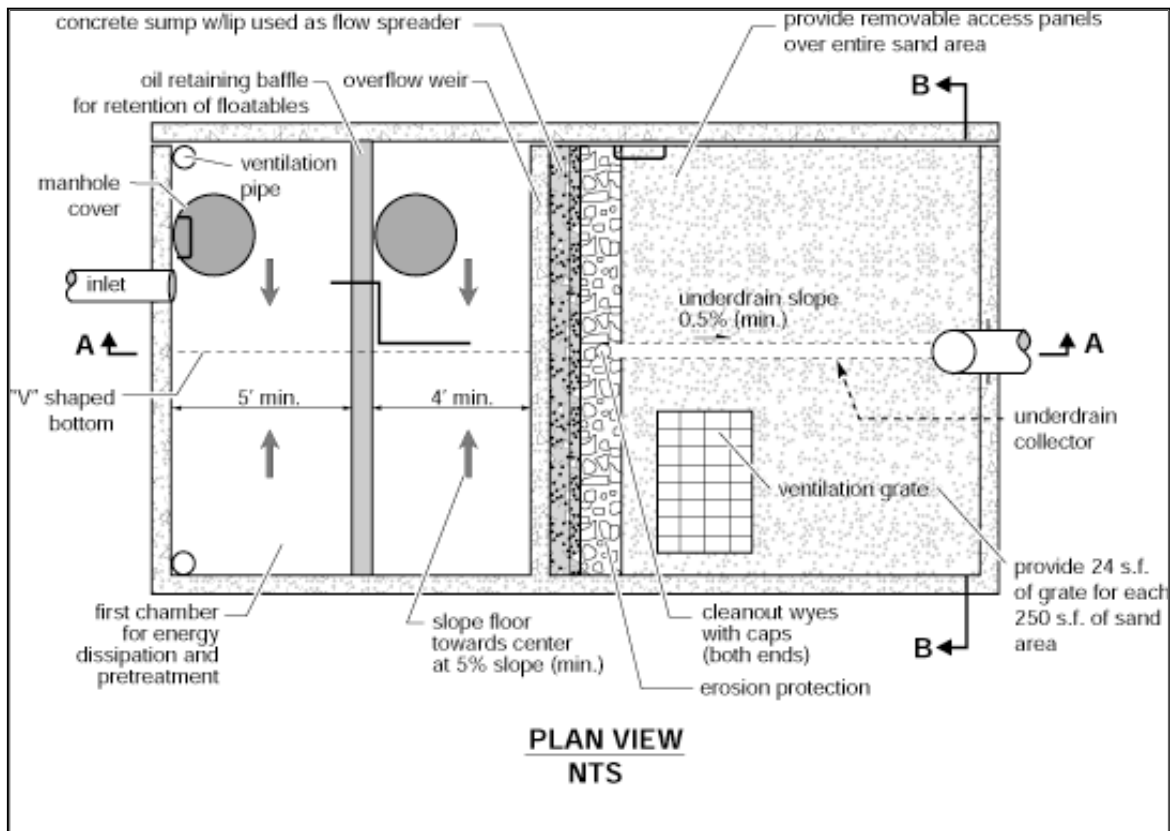
### Additional Design Criteria for Vaults

- Vaults may be designed as off-line systems or on-line for small drainages. In an off-line system a diversion structure should be installed to divert the design flow rate into the sediment chamber and bypass the remaining flow to detention/retention (if necessary to meet Minimum Requirement #7), or to surface water.
- Optimize sand inlet flow distribution with minimal sand bed disturbance. A maximum of 8-inch distance between the top of the spreader and the top of the sand bed is suggested. Flows may enter the sand bed by spilling over the top of the wall into a flow spreader pad or alternatively a pipe and manifold system may be used. Any pipe and manifold system must retain the required dead storage volume in the presettling basin, minimize turbulence, and be readily maintainable.
- If an inlet pipe and manifold system is used, the minimum pipe size should be 8 inches. Multiple inlets are recommended to minimize turbulence and reduce local flow velocities.
- Erosion protection must be provided along the first foot of the sand bed adjacent to the spreader. Geotextile fabric secured on the surface of the sand bed, or equivalent method, may be used.

- The filter bed should consist of a sand top layer, and a geotextile fabric second layer with an underdrain system.
- Design the presettling cell for sediment collection and removal. A V-shaped bottom, removable bottom panels, or equivalent sludge handling system should be used. One-foot of sediment storage in the presettling cell must be provided.
- The presettling chamber must be sealed to trap oil and trash. This chamber is usually connected to the sand filtration chamber through an invert elbow to protect the filter surface from oil and trash.
- If a retaining baffle is necessary for oil/floatables in the presettling cell, it must extend at least one foot above to one foot below the design flow water level. Provision for the passage of flows in the event of plugging must be provided. Access opening and ladder must be provided on both sides of the baffle.
- To prevent anoxic conditions, a minimum of 24 square feet of ventilation grate should be provided for each 250 square feet of sand bed surface area. For sufficient distribution of airflow across the sand bed, grates may be located in one area if the sand filter is small, but placement at each end is preferred. Small grates may also be dispersed over the entire sand bed area.
- Provision for access must utilize vault doors consistent with design criteria for wet vaults ([BMP T10.20](#)). Removable panels must be provided over the entire sand bed.
- Sand filter vaults must conform to the materials and structural suitability criteria specified for wet vaults ([BMP T10.20](#)).
- Provide a sand filter inlet shutoff/bypass valve for maintenance
- A geotextile fabric over the entire sand bed may be installed that is flexible, highly permeable, three-dimensional matrix, and adequately secured. This is useful in trapping trash and litter.

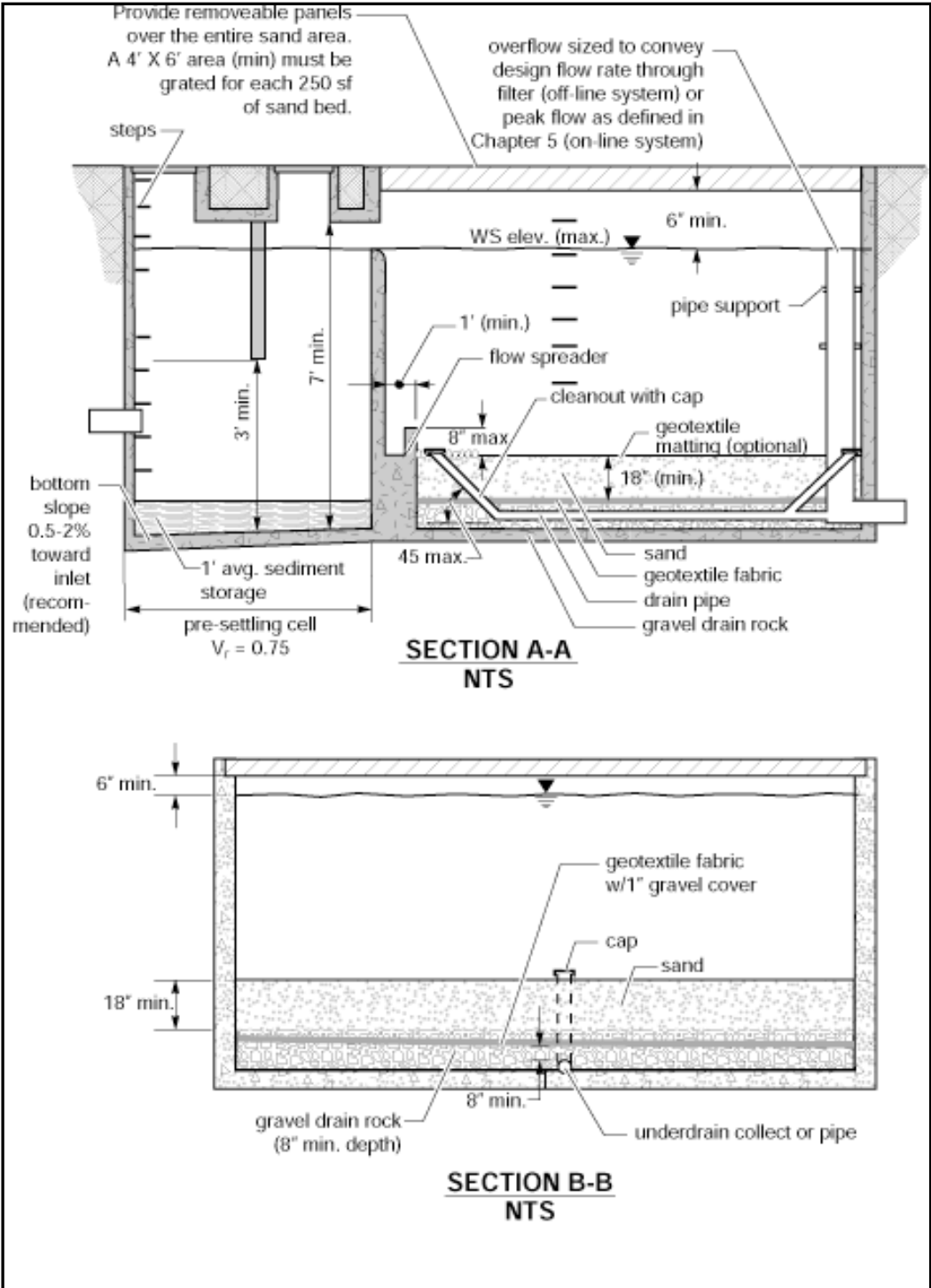
## Construction Criteria

See Basic Sand Filter Basin, [BMP T8.10](#).



**Figure 4.11: Sand Filter Vault Plan View**

(Note: Hinged locking doors are to be provided for all access locations to this vault)



**Figure 4.12: Sand Filter Vault**

(Note: Hinged locking doors are to be provided for all access locations to this vault)

## BMP T8.30: Linear Sand Filter

---

### Purpose and Description

Linear sand filters are typically long, shallow, two-celled, rectangular vaults. The first cell is designed for settling coarse particles, and the second cell contains the sand bed. Stormwater flows into the second cell via a weir section that also functions as a flow spreader.

### Cross Reference Guide

Soils Assessment	None
Minimum Requirements/ Treatment Type	MR #6 Basic (when combined with a pretreatment BMP) Phosphorus, or Enhanced with treatment train
Related BMPs	<a href="#">BMP T6.10</a> for pretreatment <a href="#">BMP T9.40</a> for a treatment train
Selection/Infeasibility Criteria	<a href="#">Book 1, Section 3.2 and Section 3.4.2</a>
Maintenance	<a href="#">Book 4</a>

### Application, Limitations and Setbacks

Linear sand filters are normally used in the following situations:

- In long narrow spaces such as the perimeter of a paved surface.
- As a part of a treatment train downstream of a filter strip, upstream of an infiltration system, or upstream of a wet pond or a biofilter for oil control.
- To treat small drainages (less than 2 acres of impervious area).
- To treat runoff from high-use sites for TSS and oil/grease removal, if applicable.

For Cross Reference refer to [BMP T8.10](#) Basic Sand Filter Basin

#### Setbacks

See [Section 3.1.4](#).

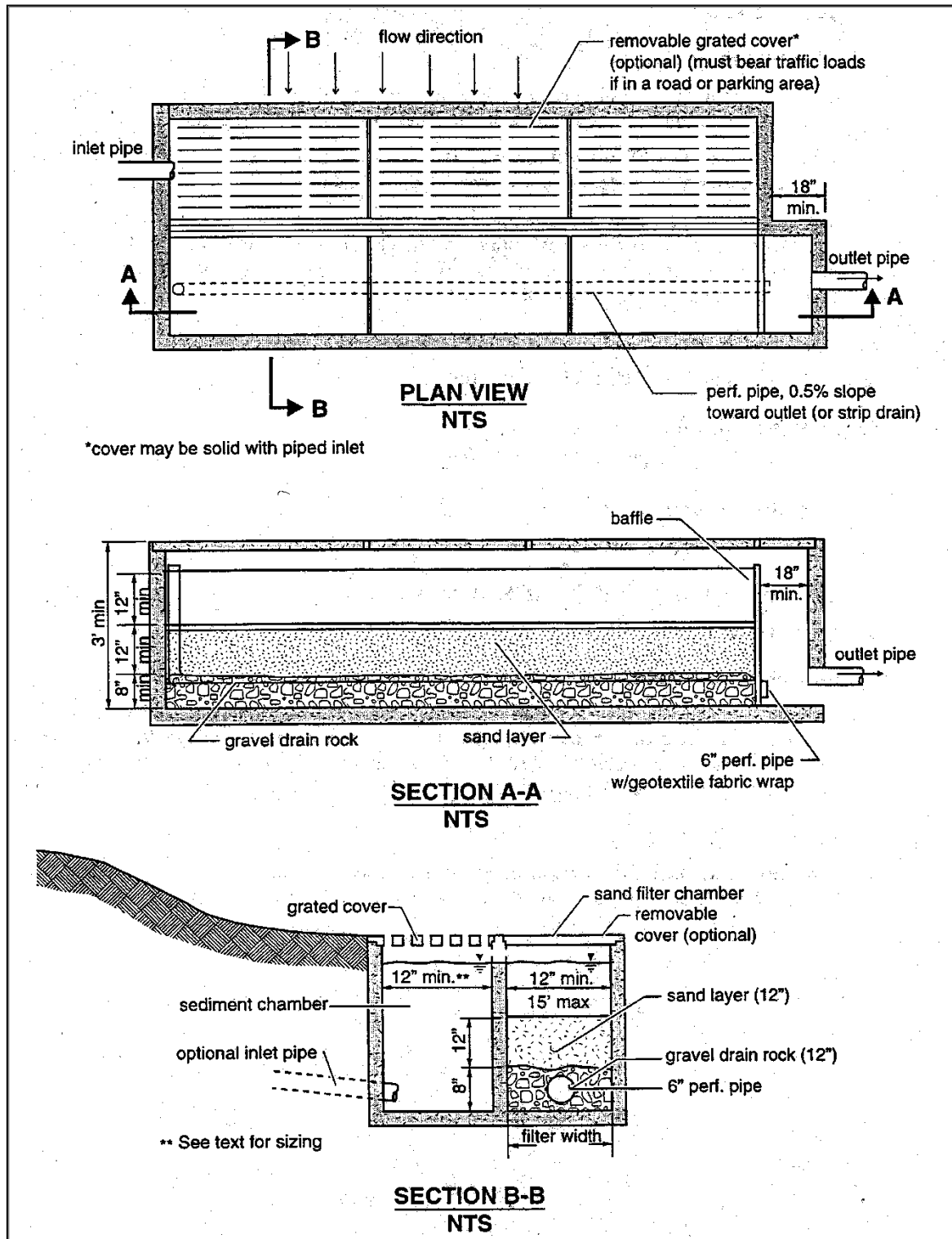
#### Design Criteria

- The two cells must be divided by a divider wall that is level and extends a minimum of 12 inches (minimum of 6 inches) above the sand bed.



- Stormwater may enter the sediment cell by sheet flow or a piped inlet.
- The width of the sand cell must be 1-foot minimum to 15 feet maximum.
- The sand filter bed must be a minimum of 12 inches deep and have an 8-inch layer of drain rock with perforated drainpipe beneath the sand layer.
- The drainpipe must be 6-inch diameter minimum and be wrapped in geotextile and sloped a minimum of 0.5 percent.
- Maximum sand bed ponding depth is 1 foot.
- Must be vented as for sand filter vaults.
- Linear sand filters must conform to the materials and structural suitability criteria specified for wet vaults ([BMP T10.20](#)).
- Set sediment cell width as follows:

Sand filter width, (w) inches	12-24	24-48	48-72	72+
Sediment cell width, inches	12	18	24	w/3



**Figure 4.13: Linear Sand Filter**  
 (Source: Department of Ecology)

## BMP T8.40: Media Filter Drain (previously “Ecology Embankment”)

---

### Purpose and Description

The media filter drain (MFD), previously called the Ecology Embankment, is a linear flow-through stormwater runoff treatment device that can be sited along highway side slopes (conventional design) and medians (dual media filter drains), borrow ditches, or other linear depressions. Cut-slope applications may also be considered. The media filter drain can be used where available right of way is limited, sheet flow from the highway surface is feasible, and lateral gradients are generally less than 25%. The media filter drain has a General Use Level Designation (GULD) for basic, enhanced, and phosphorus treatment. Updates/changes to the use-level designation and any design changes will be posted in the *Postpublication Updates* section of the HRM Resource Web Page.

The media filter drain removes suspended solids, phosphorus, and metals from highway runoff through physical straining, ion exchange, carbonate precipitation, and biofiltration.

Media filter drains have four basic components: a gravel no-vegetation zone, a grass strip, the MFD mix bed, and a conveyance system for flows leaving the MFD mix. This conveyance system usually consists of a gravel-filled underdrain trench or a layer of crushed surfacing base course (CSBC). This layer of CSBC must be porous enough to allow treated flows to freely drain away from the MFD mix.

Stormwater runoff is conveyed to the media filter drain via sheet flow over a vegetation-free gravel zone to ensure sheet dispersion and provide some pollutant trapping. Next, a grass strip, which may be amended with compost, is incorporated into the top of the fill slope to provide pretreatment, further enhancing filtration and extending the life of the system. The runoff is then filtered through a bed of porous, alkalinity-generating granular medium – the media filter drain mix – to buffer acidic pH conditions, exchange light metals for heavy metals, and remove solids, metals, and nutrients. Treated water drains from the media filter drain mix bed into the conveyance system below. Geotextile lines the underside of the media filter drain mix bed and the conveyance system.

The underdrain trench is an option for hydraulic conveyance of treated stormwater to a desired location, such as a downstream flow control facility or stormwater outfall. The trench perforated underdrain pipe is a protective measure to ensure free flow through the media filter drain mix and to prevent prolonged ponding. It may be possible to omit the underdrain pipe if it can be demonstrated that the pipe is not necessary to maintain free flow through the media filter drain mix and underdrain trench.

It is critical to note that water should sheet flow across the media filter drain. Channelized flows or ditch flows running down the middle of the dual media filter drain (continuous off-site inflow) should be minimized.

## Cross Reference Guide

Soils Assessment	None
Minimum Requirements/ Treatment Type	MR #6 Basic, Phosphorus (stand-alone), or Enhanced (with and without treatment train)
Related BMPs	<a href="#">BMP T8.10</a> , <a href="#">BMP T8.20</a> , <a href="#">BMP D6.40</a> for a treatment train
Selection/Infeasibility Criteria	<a href="#">Book 1, Section 3.2 and Section 3.4.3</a>
Maintenance	<a href="#">Book 4</a>

## Application, Limitations and Setbacks

In many instances, conventional runoff treatment is not feasible due to right of way constraints (such as adjoining wetlands and geotechnical considerations). The media filter drain and the dual media filter drain designs are runoff treatment options that can be sited in most right of way confined situations. In many cases, a media filter drain or a dual media filter drain can be sited without the acquisition of additional right of way needed for conventional stormwater facilities or capital-intensive expenditures for underground wet vaults.

### Applications

Since maintaining sheet flow across the media filter drain is required for its proper function, the ideal locations for media filter drains in highway settings are highway side slopes or other long, linear grades with lateral side slopes less than 4H:1V and longitudinal slopes no steeper than 5%.

As side slopes approach 3H:1V, without design modifications, sloughing may become a problem due to friction limitations between the separation geotextile and underlying soils. The longest flow path from the contributing area delivering sheet flow to the media filter drain should not exceed 150 feet.

If there is sufficient roadway embankment width, the designer should consider placing the grass strip and media mix downslope when feasible. Ensure the MFD does not intercept seeps, springs, or groundwater.

### Dual Media Filter Drain for Highway Medians

The dual media filter drain is fundamentally the same as the side-slope version. It differs in siting and is more constrained with regard to drainage options. Prime locations for dual media filter drains in a highway setting are medians, roadside drainage or borrow ditches, or other linear depressions. It

is especially critical for water to sheet flow across the dual media filter drain. Channelized flows or ditch flows running down the middle of the dual media filter drain (continuous off-site inflow) should be minimized.

### Limitations

- **Steep slopes.** Avoid construction on longitudinal slopes steeper than 5%. Avoid construction on 3H:1V lateral slopes, and preferably use less than 4H:1V slopes. In areas where lateral slopes exceed 4H:1V, it may be possible to construct terraces to create 4H:1V slopes or to otherwise stabilize up to 3H:1V slopes. (For details, see *Geometry, Components and Sizing Criteria, Cross Section* in the Structural Design Considerations section below).
- **Wetlands.** Do not construct in wetlands and wetland buffers. In many cases, a media filter drain (due to its small lateral footprint) can fit within the highway fill slopes adjacent to a wetland buffer. In those situations where the highway fill prism is located adjacent to wetlands, an interception trench/underdrain will need to be incorporated as a design element in the media filter drain.
- **Shallow groundwater.** Mean high water table levels at the project site need to be determined to ensure the media filter drain mix bed and the underdrain (if needed) will not become saturated by shallow groundwater.
- **Unstable slopes.** In areas where slope stability may be problematic, consult a geotechnical engineer.

### Setbacks

See [Section 3.1.4](#).

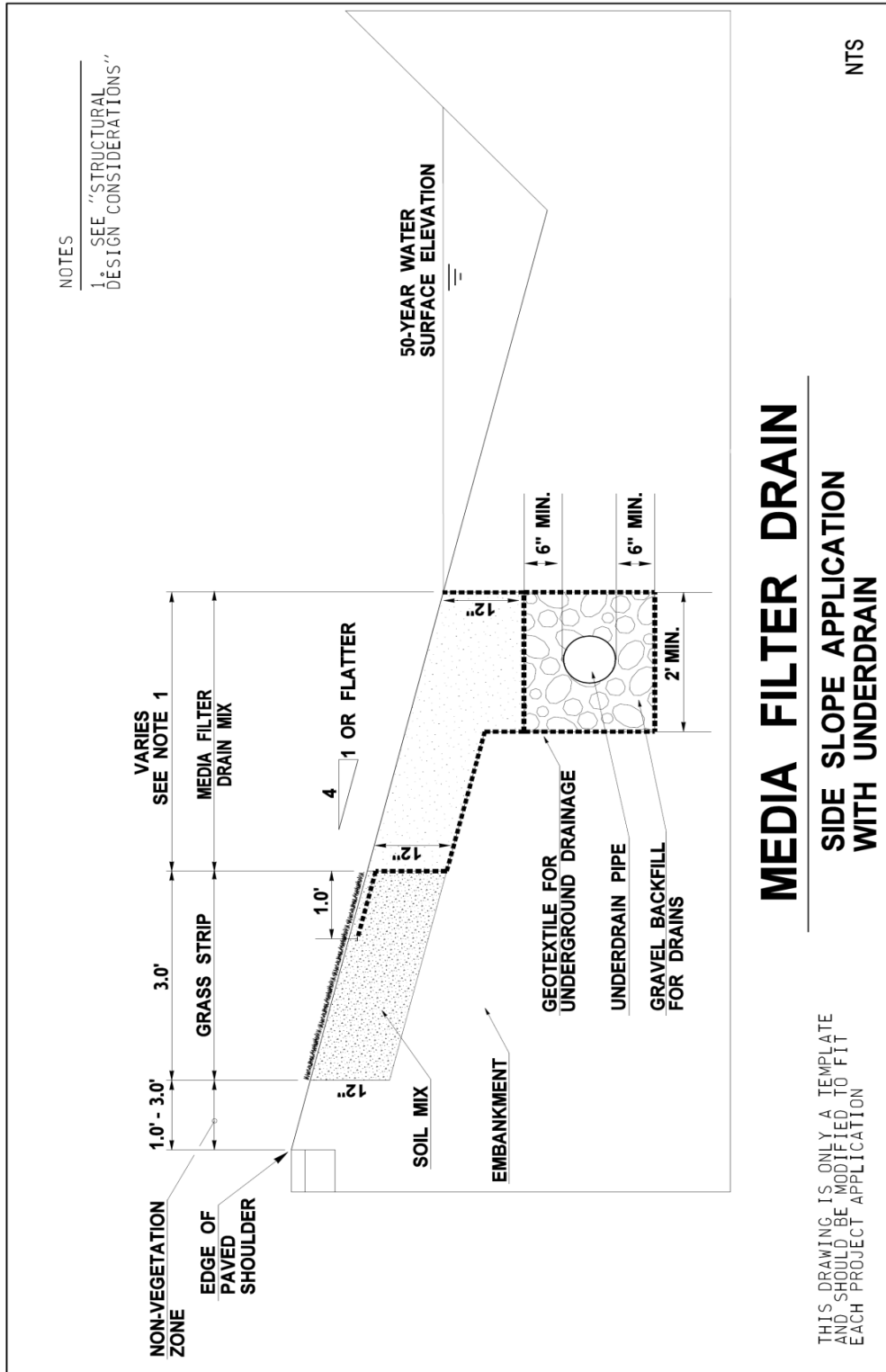
### Design Criteria

The basic design concept behind the media filter drain and dual media filter drain is to fully filter all runoff through the media filter drain mix. Therefore, the infiltration capacity of the medium and drainage below needs to match or exceed the hydraulic loading rate.

### Geometry and Components

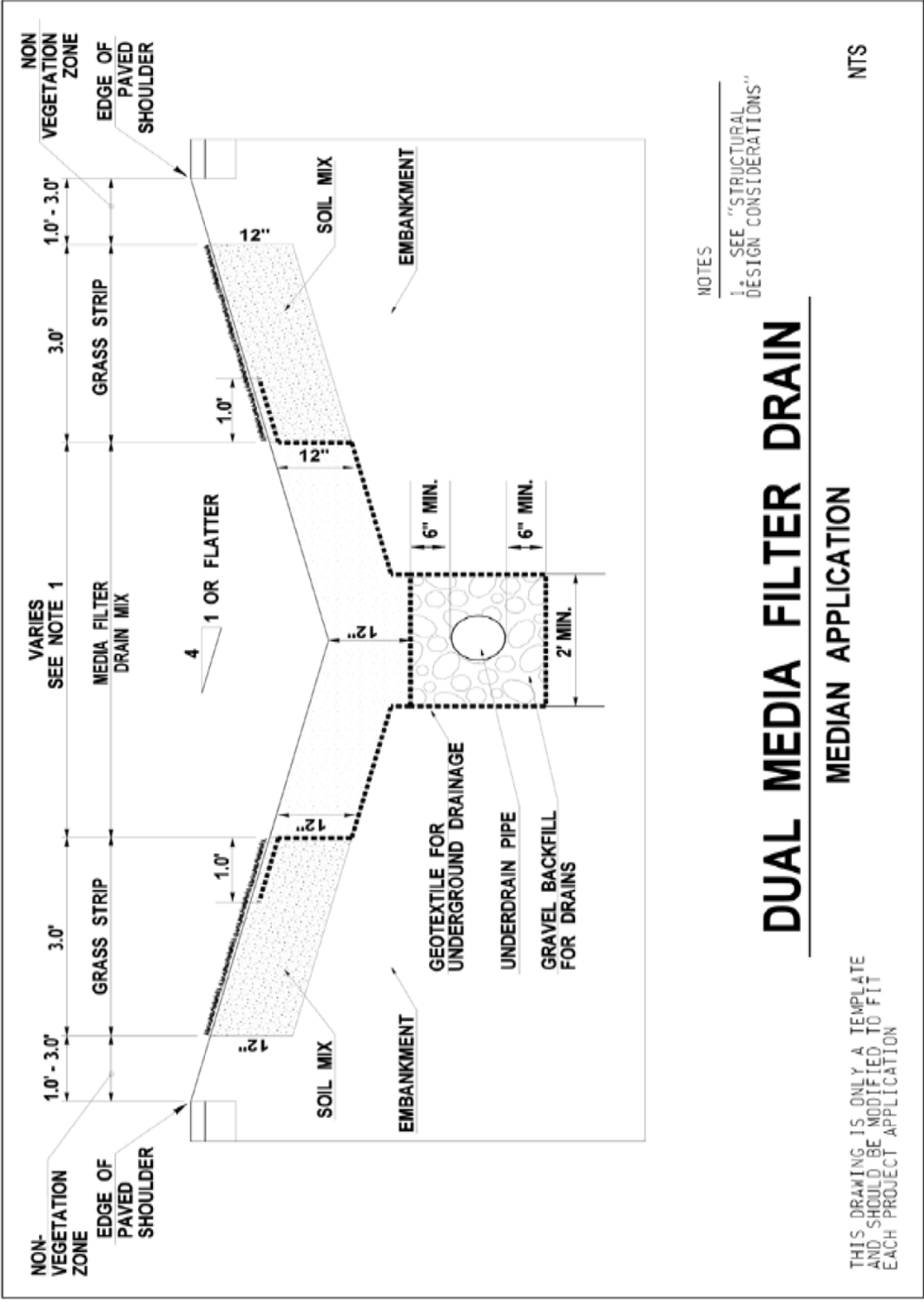
#### No-Vegetation Zone

The no-vegetation zone is a shallow gravel zone directly adjacent to the highway pavement. The no-vegetation zone functions as a level spreader to promote sheet flow and a deposition area for coarse sediments. It should be between 1 foot and 3 feet wide. Depth will be a function of how the roadway section is built from subgrade to finish grade; the resultant cross-section will typically be triangular to trapezoidal. Within these bounds, width varies depending on maintenance spraying practices.

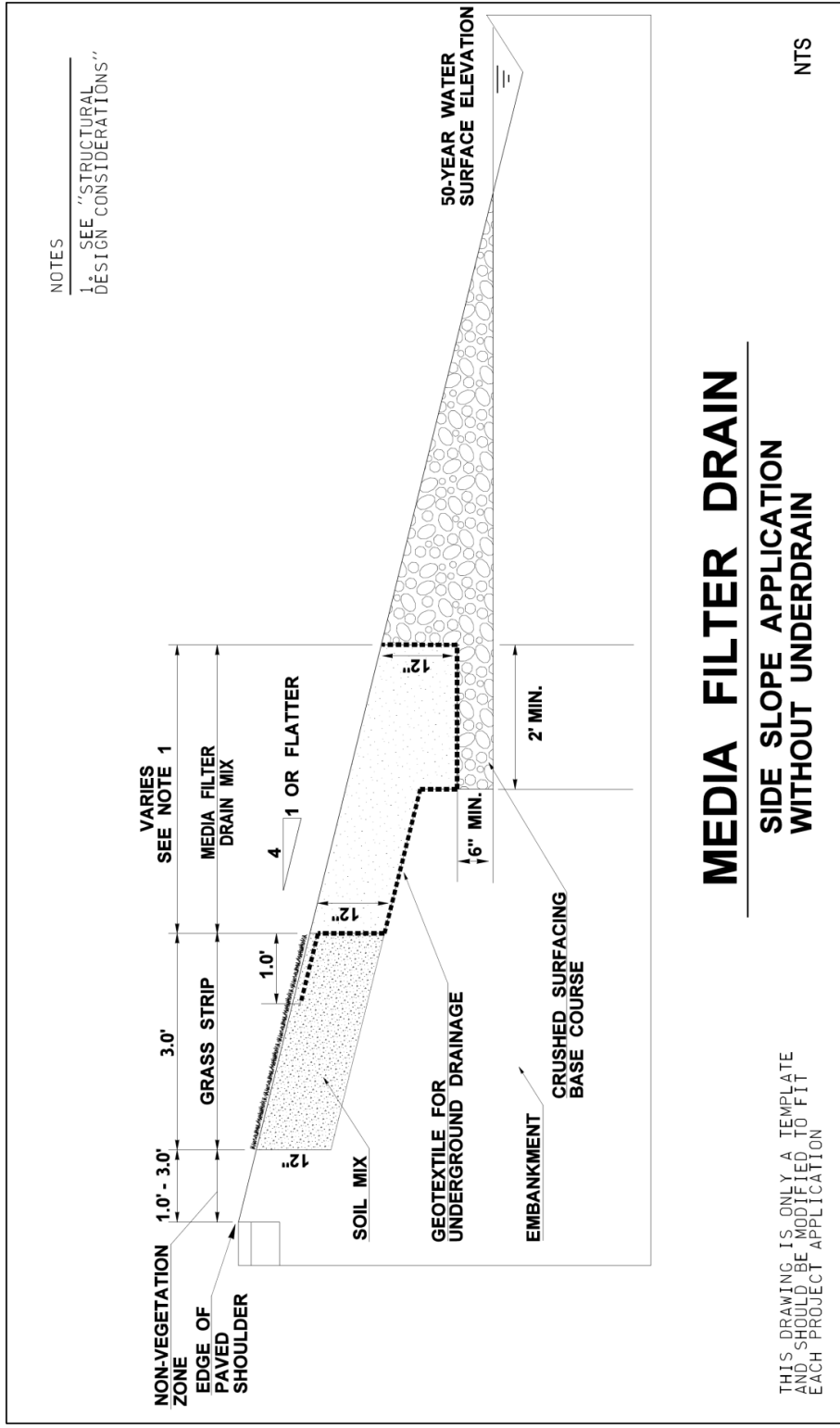


**Figure 4.14: Media Filter Drain, Cross-section**

(Source: WSDOT Highway Runoff Manual)



**Figure 4.15: Dual Media Filter Drain, Cross-section**  
(Source: WSDOT Highway Runoff Manual)



**Figure 4.16: Media Filter Drain without underdrain trench**

(Source: WSDOT Highway Runoff Manual)



### Grass Strip

The width of the grass strip is dependent on the availability of space within the highway side slope. The minimum width is 3 feet, but wider grass strips are recommended if additional space is available. Consider adding aggregate to the soil mix to help minimize rutting problems from errant vehicles. The soil mix should ensure grass growth for the design life of the media filter drain.

### Media Filter Drain Mix Bed

The media filter drain mix is a mixture of crushed rock, dolomite, gypsum, and perlite. The crushed rock provides the support matrix of the medium; the dolomite and gypsum add alkalinity and ion exchange capacity to promote the precipitation and exchange of heavy metals; and the perlite improves moisture retention to promote the formation of biomass within the media filter drain mix. The combination of physical filtering, precipitation, ion exchange, and biofiltration enhances the water treatment capacity of the mix. The media filter drain mix has an estimated initial filtration rate of 50 inches per hour and a long-term filtration rate of 28 inches per hour. With an additional safety factor, the rate used to size the length of the media filter drain should be 10 inches per hour.

### Conveyance System Below Media Filter Drain Mix

The gravel underdrain trench provides hydraulic conveyance when treated runoff needs to be conveyed to a desired location such as a downstream flow control facility or stormwater outfall.

In Group 3, 4, or 5 soils, an underdrain pipe helps ensure free flow of the treated runoff through the media filter drain mix bed. In some Group 1 and 2 soils, an underdrain pipe may be unnecessary if most water percolates into subsoil from the underdrain trench. The need for underdrain pipe must be evaluated in all cases. The underdrain trench must be a minimum of 2 feet wide for either the conventional or dual media filter drain.

The gravel underdrain trench may be eliminated if there is evidence to support that flows can be conveyed laterally to an adjacent ditch or onto a fill slope that is properly vegetated to protect against erosion. The media filter drain mix must be kept free draining up to the 50-year storm event water surface elevation represented in the downstream ditch.

## **Sizing Criteria**

### Width

The width of the media filter drain mix bed is determined by the amount of contributing pavement routed to the embankment. The surface area of the media filter drain mix bed must be sufficiently large to fully infiltrate the runoff treatment design flow rate using the long-term filtration rate of the media filter drain mix. For design purposes, a 50% safety factor is incorporated into the long-term media filter drain mix filtration rate to accommodate variations in slope, resulting in a design filtration rate of 10 inches per hour. The media filter drain mix bed should have a bottom width of at least 2 feet in contact with the conveyance system below the media filter drain mix.

## Length

In general, the length of a MFD or dual media filter drain is the same as the contributing pavement. Any length is acceptable as long as the surface area media filter drain mix bed is sufficient to fully infiltrate the runoff treatment design flow rate.

## Cross-section

In profile, the surface of the media filter drain must have a lateral slope less than 4H:1V (25%). On steeper terrain, it may be possible to construct terraces to create a 4H:1V slope to ensure slope stability up to 3H:1V. If sloughing is a concern on steeper slopes, consideration should be given to incorporating permeable soil reinforcements, such as geotextiles, open-graded/ permeable pavements, or commercially available ring and grid reinforcement structures, as top layer components to the media filter drain mix bed. Consultation with a geotechnical engineer is required.

## Inflow

Runoff is conveyed to a media filter drain using sheet flow from the pavement area. The longitudinal pavement slope contributing flow to a media filter drain should be less than 5%.

Although there is no lateral pavement slope restriction for flows going to a media filter drain, the designer should ensure flows remain as sheet flow.

## Media Filter Drain Mix Bed Sizing Procedure

The media filter drain mix should be a minimum of 12 inches deep, including the section on top of the underdrain trench.

For runoff treatment, sizing the media filter drain mix bed is based on the requirement that the runoff treatment flow rate from the pavement area,  $Q_{\text{Highway}}$ , cannot exceed the long-term infiltration capacity of the media filter drain,  $Q_{\text{Infiltration}}$ :

$$Q_{\text{infiltration}} \leq Q_{\text{Highway}}$$

For Clark County and other areas of western Washington,  $Q_{\text{Highway}}$  is the flow rate at or below which 91% of the runoff volume for the developed threshold discharge area will be treated, based on a 15-minute time step, and can be determined using an approved continuous flow model. Use [Table 4.3](#) to determine the MFD width.

**Table 4.3: Design Widths for Media Filter Drains**

Pavement width that contributes runoff to the media filter drain	Minimum media filter drain width*
≤ 20 feet	2 feet
≥ 20 and ≤ 35 feet	3 feet
> 35 feet	4 feet
* Width does not include the required 1–3 foot gravel vegetation-free zone or the 3-foot filter strip width	

### Underdrain Sizing

Underdrain pipe can provide a protective measure to ensure free flow through the media filter drain (MFD) mix and is sized similar to storm drains. For MFD underdrain sizing, an additional step is required to determine the flow rate that can reach the underdrain pipe. This is done by comparing the contributing basin flow rate to the infiltration flow rate through the media filter mix and then using the smaller of the two to size the underdrain. The analysis described below considers the flow rate per foot of MFD, which allows the flexibility of incrementally increasing the underdrain diameter where long lengths of underdrain are required. When underdrain pipe connects to a storm drain system, place the invert of the underdrain pipe above the 25-year water surface elevation in the storm drain to prevent backflow into the underdrain system.

The following describes the procedure for sizing underdrains installed in combination with media filter drains.

1. Calculate the flow rate per foot from the contributing basin to the media filter drain. The design storm event used to determine the flow rate should be relevant to the purpose of the underdrain. For example, if the MFD installation is in western Washington and the underdrain will be used to convey treated runoff to a detention BMP, size the underdrain for the 50-year storm event. (See the Washington State Department of Transportation's *Hydraulics Manual*, Figure 2-2.1, for conveyance flow rate determination.)

$$\frac{Q_{highway}}{ft} = \frac{Q_{highway}}{L_{MFD}}$$

where:

$$\frac{Q_{highway}}{ft} = \text{contributing flow rate per foot (cfs/ft)}$$

$$L_{MFD} = \text{length of MFD contributing runoff to the underdrain (ft)}$$

- Calculate the MFD flow rate of runoff per foot given an infiltration rate of 10 in/hr through the media filter drain mix.

$$Q_{\frac{MFD}{ft}} = \frac{f \times W \times 1ft}{ft} \times \frac{1ft}{12in} \times \frac{1hr}{3600sec}$$

where:

$$Q_{\frac{MFD}{ft}} = \text{flow rate of runoff through MFD mix layer (cfs/ft)}$$

W = width of underdrain trench (ft) –the minimum width is 2 ft

f = infiltration rate through the MFD mix (in/hr) = 10 in/hr

- Size the underdrain pipe to convey the runoff that can reach the underdrain trench. This is taken to be the smaller of the contributing basin flow rate or the flow rate through the MFD mix layer.

$$Q_{\frac{UD}{ft}} = \text{smaller} \left\{ Q_{\frac{highway}{ft}} \text{ or } Q_{\frac{MFD}{ft}} \right\}$$

where:

$$Q_{\frac{UD}{ft}} = \text{underdrain design flow rate per foot (cfs/ft)}$$

- Determine the underdrain design flow rate using the length of the MFD and a factor of safety of 1.2.

$$Q_{UD} = 1.2 \times Q_{\frac{UD}{ft}} \times W \times L_{MFD}$$

where:

$Q_{UD}$  = estimated flow rate to the underdrain (cfs)

W = width of the underdrain trench (ft) – see Standard Plan B-55.20-00; the minimum width is 2 ft

$L_{MFD}$  = length of MFD contributing runoff to the underdrain (ft)

- Given the underdrain design flow rate, determine the underdrain diameter. Round pipe diameters to the nearest standard pipe size and have a minimum diameter of 6 inches. For diameters that exceed 12 inches, contact either the Region or HQ Hydraulics Office.

$$D = 16 \left( \frac{(Q_{UD} \times n)}{s^{0.5}} \right)^{3/8}$$

where:

- D = underdrain pipe diameter (inches)  
 n = Manning's coefficient  
 s = slope of pipe (ft/ft)

## Materials

### Media Filter Drain Mix

The media filter drain mix used in the construction of media filter drains consists of the amendments listed in [Table 4.4](#). Mixing and transportation must occur in a manner that ensures the materials are thoroughly mixed prior to placement and that separation does not occur during transportation or construction operations.

These materials should be used in accordance with the following WSDOT Standard Specifications:

- Gravel Backfill for Drains, 9-03.12(4)
- Underdrain Pipe, 7-01.3(2)
- For Geotextile, reference specifications in [Appendix 2-G](#).

### Crushed Surfacing Base Course (CSBC)

If the design is configured to allow the media filter drain to drain laterally into a ditch, the crushed surfacing base course below the media filter drain should conform to Section 9-03.9(3) of the Washington State Department of Transportation's *Standard Specifications for Road, Bridge, and Municipal Construction*.

## Berms, Baffles, and Slopes

Lateral slopes must be less than 4H:1V. See additional sideslope information in the *Cross-section* heading above, and in [Section 3.1.4](#).

**Table 4.4: Media Filter Drain Mix**

Amendment	Quantity												
<p>Mineral aggregate: Aggregate for Media Filter Drain Mix</p> <p>Aggregate for Media filter Drain Mix shall be manufactured from ledge rock, talus, or gravel in accordance with Section 3-01 of the <i>Standard Specifications for Road, Bridge, and Municipal Construction</i> (2002), which meets the following test requirements for quality. The use of recycled material is not permitted.</p> <p>Los Angeles Wear, 500 Revolutions    35% max.</p> <p>Degradation Factor                              30 min.</p> <p>Aggregate for the Media Filter Drain Mix shall conform to the following requirements for grading and quality:</p> <table style="width: 100%; border-collapse: collapse;"> <thead> <tr> <th style="text-align: left;">Sieve Size</th> <th style="text-align: left;">Percent Passing (by weight)</th> </tr> </thead> <tbody> <tr> <td>1/2" square</td> <td>100</td> </tr> <tr> <td>3/8" square</td> <td>90-100</td> </tr> <tr> <td>U.S. No. 4</td> <td>30-56</td> </tr> <tr> <td>U.S. No. 10</td> <td>0-10</td> </tr> <tr> <td>U.S. No. 200</td> <td>0-1.5</td> </tr> </tbody> </table> <p>% fracture, by weight, min.    75</p> <p>Static stripping test                              Pass</p> <p>The fracture requirement shall be at least two fractured faces and will apply to material retained on the U.S. No. 10.</p> <p>Aggregate for the Media Filter Drain shall be substantially free from adherent coatings. The presence of a thin, firmly adhering film of weathered rock shall not be considered as coating unless it exists on more than 50% of the surface area of any size between successive laboratory sieves.</p>	Sieve Size	Percent Passing (by weight)	1/2" square	100	3/8" square	90-100	U.S. No. 4	30-56	U.S. No. 10	0-10	U.S. No. 200	0-1.5	<p>3 cubic yards</p>
Sieve Size	Percent Passing (by weight)												
1/2" square	100												
3/8" square	90-100												
U.S. No. 4	30-56												
U.S. No. 10	0-10												
U.S. No. 200	0-1.5												
<p>Perlite:</p> <ul style="list-style-type: none"> <li><input type="checkbox"/> Horticultural grade, free of any toxic materials)</li> <li><input type="checkbox"/> 0-30% passing US No. 18 Sieve</li> <li><input type="checkbox"/> 0-10% passing US No. 30 Sieve</li> </ul>	<p>1 cubic yard per 3 cubic yards of mineral aggregate</p>												
<p>Dolomite: CaMg(CO<sub>3</sub>)<sub>2</sub> (calcium magnesium carbonate)</p> <ul style="list-style-type: none"> <li><input type="checkbox"/> Agricultural grade, free of any toxic materials)</li> <li><input type="checkbox"/> 100% passing US No. 8 Sieve</li> <li><input type="checkbox"/> 0% passing US No. 16 Sieve</li> </ul>	<p>10 pounds per cubic yard of perlite</p>												
<p>Gypsum: Noncalcined, agricultural gypsum CaSO<sub>4</sub>•2H<sub>2</sub>O (hydrated calcium sulfate)</p> <ul style="list-style-type: none"> <li><input type="checkbox"/> Agricultural grade, free of any toxic materials)</li> <li><input type="checkbox"/> 100% passing US No. 8 Sieve</li> <li><input type="checkbox"/> 0% passing US No. 16 Sieve</li> </ul>	<p>1.5 pounds per cubic yard of perlite</p>												

### Landscaping (Planting Considerations)

Landscaping for the grass strip is the same as for biofiltration swales ([BMP T9.10](#)).

### Construction Criteria

Keep effective erosion and sediment control measures in place until grass strip is established.

Do not allow vehicles or traffic on the MFD to minimize rutting and maintenance repairs.

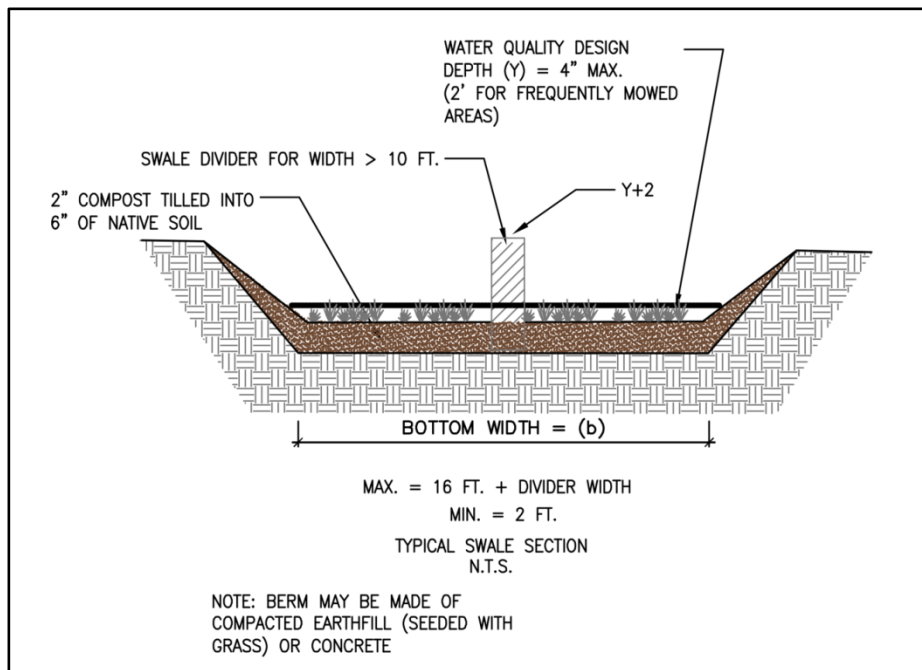
### Signing

Nonreflective guideposts at least three foot high and 3-inches wide are required to delineate the media filter drain. This practice allows personnel to identify where the system is installed and to make appropriate repairs should damage occur to the system. If the media filter drain is in a critical aquifer recharge area for drinking water supplies, signage prohibiting the use of pesticides must be provided.

## BMP T9.10: Basic Biofiltration Swale

### Purpose and Description

Biofiltration swales are typically shaped as a trapezoid or a parabola as shown below.



**Figure 4.17: Typical Swale Section**

(Source: redrawn from Stormwater Management Manual for Western Washington, 2014)

### Cross Reference Guide

Soils Assessment	None
Minimum Requirements/ Treatment Type	MR #6 Meets Basic; Meets Enhanced and Phosphorus as part of a treatment train
Related BMPs	<a href="#">BMP T8.10</a> (Enhanced or Phosphorus), <a href="#">BMP T8.20</a> (Enhanced or Phosphorus), or <a href="#">BMP T8.40</a> (Enhanced) for a treatment train.
Selection/Infeasibility Criteria	<a href="#">Book 1, Section 3.2 and Section 3.4.4</a>
Maintenance	<a href="#">Book 4</a>



## Application, Limitations and Setbacks

Data suggest that the performance of biofiltration swales is highly variable from storm to storm. Ecology recommends considering other treatment methods that perform more consistently, such as sand filters and wet ponds, before using a biofiltration swale. Biofiltration swales downstream of devices of equal or greater effectiveness can convey runoff; but do not consider them to offer a treatment benefit. (Horner, 2000).

### Setbacks

See [Section 3.1.4](#).

### Design Criteria

- [Table 4.5](#) specifies design criteria. Use a 9 minute hydraulic residence time at a multiple of the peak 15 minute Water Quality Design Flow Rate (Q) representing 91% runoff volume as determined by an approved continuous flow model.
- Check the hydraulic capacity/stability for inflows greater than design flows. Bypass high flows, or control release rates into the biofilter, if necessary.
- Install a Clark County Flow Spreader with Sediment Trap at the swale inlet (see [Figure 3.3](#)). Avoid the use of rock (e.g. quarry spalls) for energy dissipation within the swale because they make mowing and vegetation management difficult.
- Install concrete level spreaders at the head and every 50 feet in swales of  $\geq 4$  feet width. Include sediment cleanouts (weir, settling basin, or equivalent) at the head of the biofilter as needed.
- The use of riprap energy dissipaters due to increased downslopes must be approved by the Responsible Official.
- See [Section 3.1.4](#) for information on allowable side slopes.

### Guidance for Bypassing Off-line Facilities

Swales designed in an off-line mode should not engage a bypass until the flow rate exceeds a value determined by multiplying Q, the off-line water quality design flow rate predicted by an approved continuous flow model, by the ratio determined in [Figure 4.3](#), Ratio of SBUH Peak/WQ Flow for Off-Line. This modified design flow rate is an estimate of the design flow rate determined by using SBUH procedures. The only advantage of designing a swale to be off-line is that the stability check, which may make the swale larger, is not necessary.

### Sizing Procedure for Biofiltration Swales

This guide provides biofilter swale design procedures in full detail, along with examples.

### Preliminary Steps (P)

- **P-1** Determine the Water Quality design flow rate (Q) in 15-minute time-steps using the WWHM. Use the correct flow rate, off-line or on-line, for the design situation.
- **P-2** Establish the longitudinal slope of the proposed biofilter.
- **P-3** Select a vegetation cover suitable for the site. Refer to [Table 4.7](#) and [Table 4.8](#) to select vegetation for western Washington.

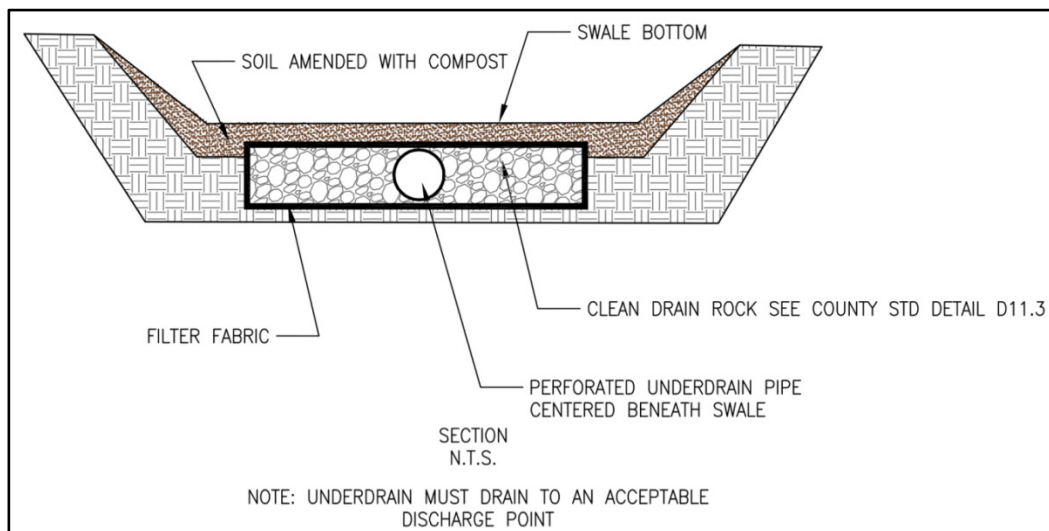
### *Design Calculations for Biofiltration Swale*

The procedure recommended here is an adaptation from the design procedure originated by Chow (Chow, 1959) for biofiltration applications in the Puget Sound region.

This procedure reverses Chow's order, designing first for capacity and then for stability. The capacity analysis emphasizes the promotion of biofiltration, rather than transporting flow with the greatest possible hydraulic efficiency. Therefore, it is based on criteria that promote sedimentation, filtration, and other pollutant removal mechanisms. Because these criteria include a lower maximum velocity than permitted for stability, the biofilter dimensions usually do not have to be modified after a stability check.

### Design Steps (D)

- **D-1.** Select the type of vegetation, and design depth of flow, based on frequency of mowing and type of vegetation. [Table 4.7](#) and [Table 4.8](#) list suitable vegetation types.
- **D-2.** Select a value of Manning's n ([Table 4.5](#) with footnote #3).



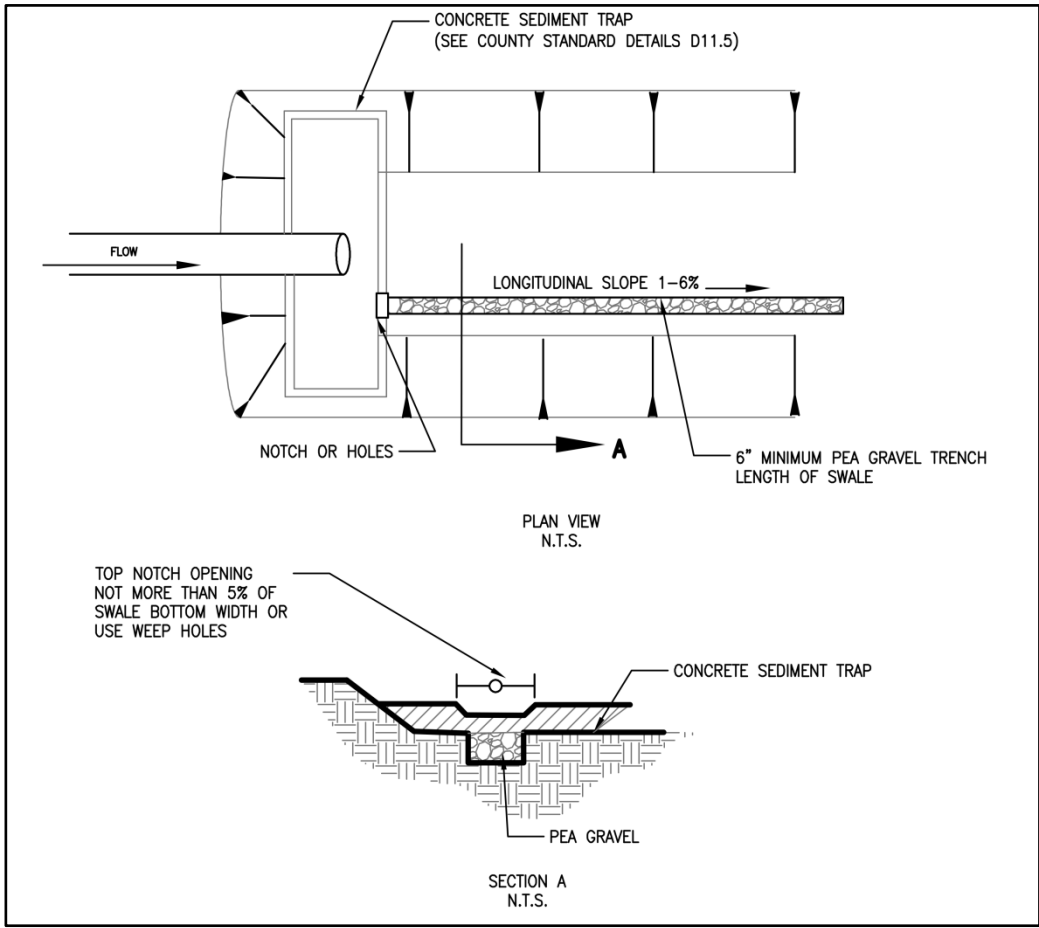
**Figure 4.18: Biofiltration Swale Underdrain Detail**

(Source: redrawn from WA State Dept. of Ecology)

**Table 4.5: Biofiltration Swale Sizing Criteria**

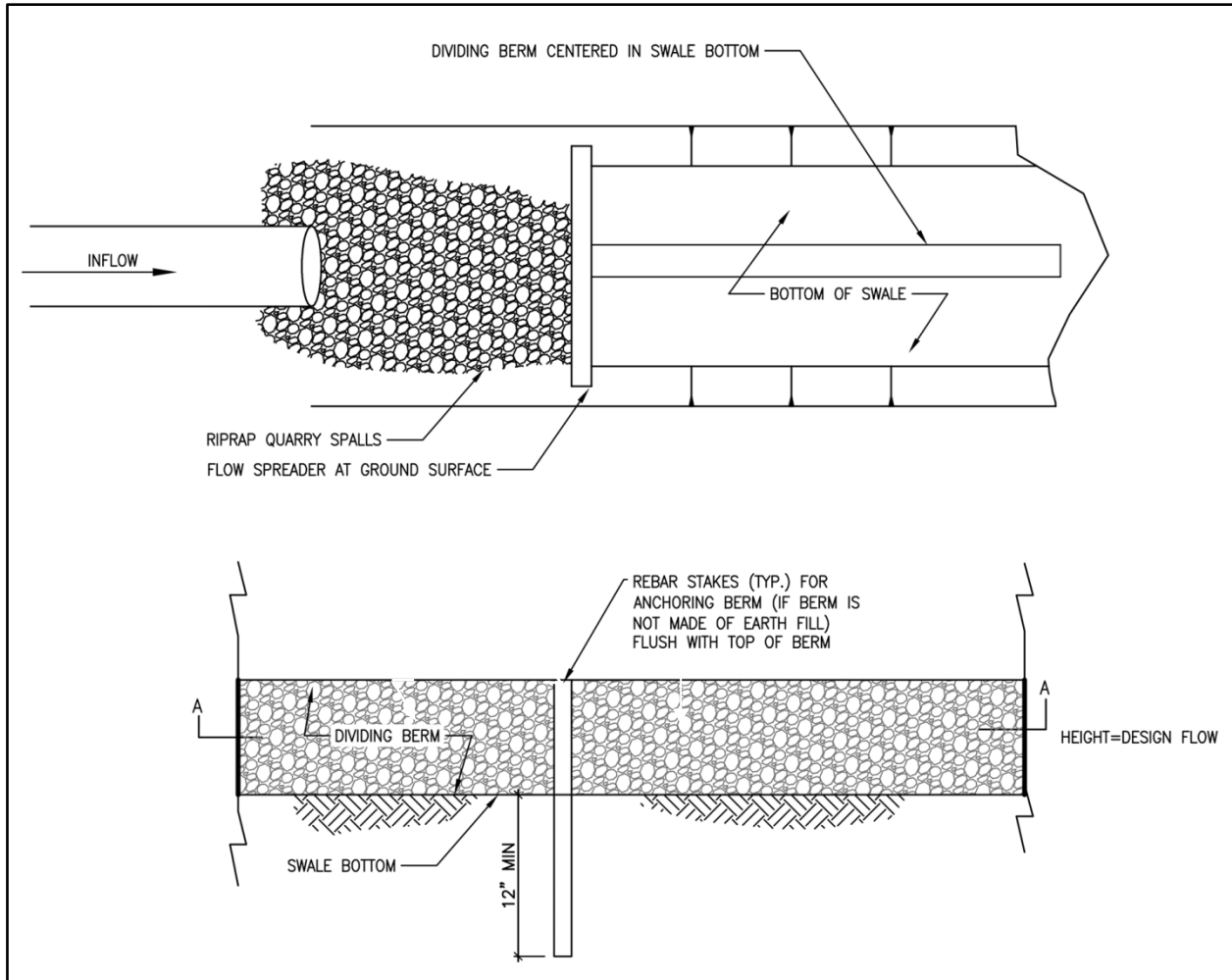
Design parameter	
Longitudinal Slope	0.015 - 0.025 <sup>1</sup>
Maximum velocity	1 ft / sec ( @ K multiplied by the WQ design flow rate ; for stability, 3 ft/sec max.
Maximum water depth <sup>2</sup>	2"- if mowed frequently; 4" if mowed infrequently
Manning coefficient (22)	(0.2 – 0.3) <sup>3</sup> (0.24 if mowed infrequently)
Bed width (bottom)	(2 - 10 ft) <sup>4</sup>
Freeboard height	0.5 ft
Minimum hydraulic residence time at Water Quality Design Flow Rate	9 minutes (18 minutes for continuous inflow)
Minimum length	100 ft
Maximum sideslope	3 H : 1 V 4H:1V preferred
Max. tributary drainage flow path	---
Max. longitudinal slope of contributing area	---
Max. lateral slope of contributing area	---

1. For swales, if the slope is less than 1.5% install an underdrain using a perforated pipe, or equivalent. Amend the soil if necessary to allow effective percolation of water to the underdrain. Install the low-flow drain 6" deep in the soil. Slopes greater than 2.5% need check dams (riprap) at vertical drops of 12-15 inches. Underdrains can be made of 6 inch Schedule 40 PVC perforated pipe with 6" of drain gravel on the pipe. The gravel and pipe must be enclosed by geotextile fabric. (See [Figure 4.18](#), underdrain detail, and [Figure 4.19](#), low-flow drain detail.)
2. Below the design water depth install an erosion control blanket, at least 4" of topsoil, and the selected biofiltration mix. Above the water line use a straw mulch or sod.
3. This range of Manning's n can be used in the equation;  $b = Qn/1.49y(1.67)s(0.5) - Zy$  with wider bottom width b, and lower depth, y, at the same flow. This provides the designer with the option of varying the bottom width of the swale depending on space limitations. Designing at the higher n within this range at the same flow decreases the hydraulic design depth, thus placing the pollutants in closer contact with the vegetation and the soil.
4. For swale widths up to 16 feet the cross-section can be divided with a berm (concrete, plastic, compacted earth fill) using a flow spreader at the inlet ([Figure 4.20](#), dividing berm).



**Figure 4.19: Biofiltration Swale Low-Flow Drain Detail**

(Source: modified from WA State Dept. of Ecology)



**Figure 4.20: Swale Dividing Berm**

(Source: redrawn from WA State Dept. of Ecology)

- **D-3.** Select swale shape-typically trapezoidal or parabolic.
- **D-4.** Use Manning's equation and first approximations relating hydraulic radius and dimensions for the selected swale shape to obtain a working value of a biofilter width dimension:

$$Q = \frac{1.49AR^{0.67}s^{0.5}}{n} \quad \text{Equation 4-1}$$

$$A_{\text{rectangle}} = Ty \quad \text{Equation 4-2}$$

$$R_{\text{rectangle}} = \frac{Ty}{T + 2y} \quad \text{Equation 4-3}$$

Where:

- $Q$  = Water Quality Design flow rate in 15-minute time steps based on WWHM, (ft<sup>3</sup>/s, cfs)
- $n$  = Manning's  $n$  (dimensionless)
- $s$  = Longitudinal slope as a ratio of vertical rise/horizontal run (dimensionless)
- $A$  = Cross-sectional area (ft<sup>2</sup>)
- $R$  = Hydraulic radius (ft)
- $T$  = top width of trapezoid or width of a rectangle (ft)
- $y$  = depth of flow (ft)
- $b$  = bottom width of trapezoid (ft)

If Equations 4-2 and 4-3 are substituted into Equation 4-1 and solved for  $T$ , complex equations result that are difficult to solve manually. However, approximate solutions can be found by recognizing that  $T \gg y$  and  $Z^2 \gg 1$ , and that certain terms are nearly negligible. The approximation solutions for rectangular and trapezoidal shapes are:

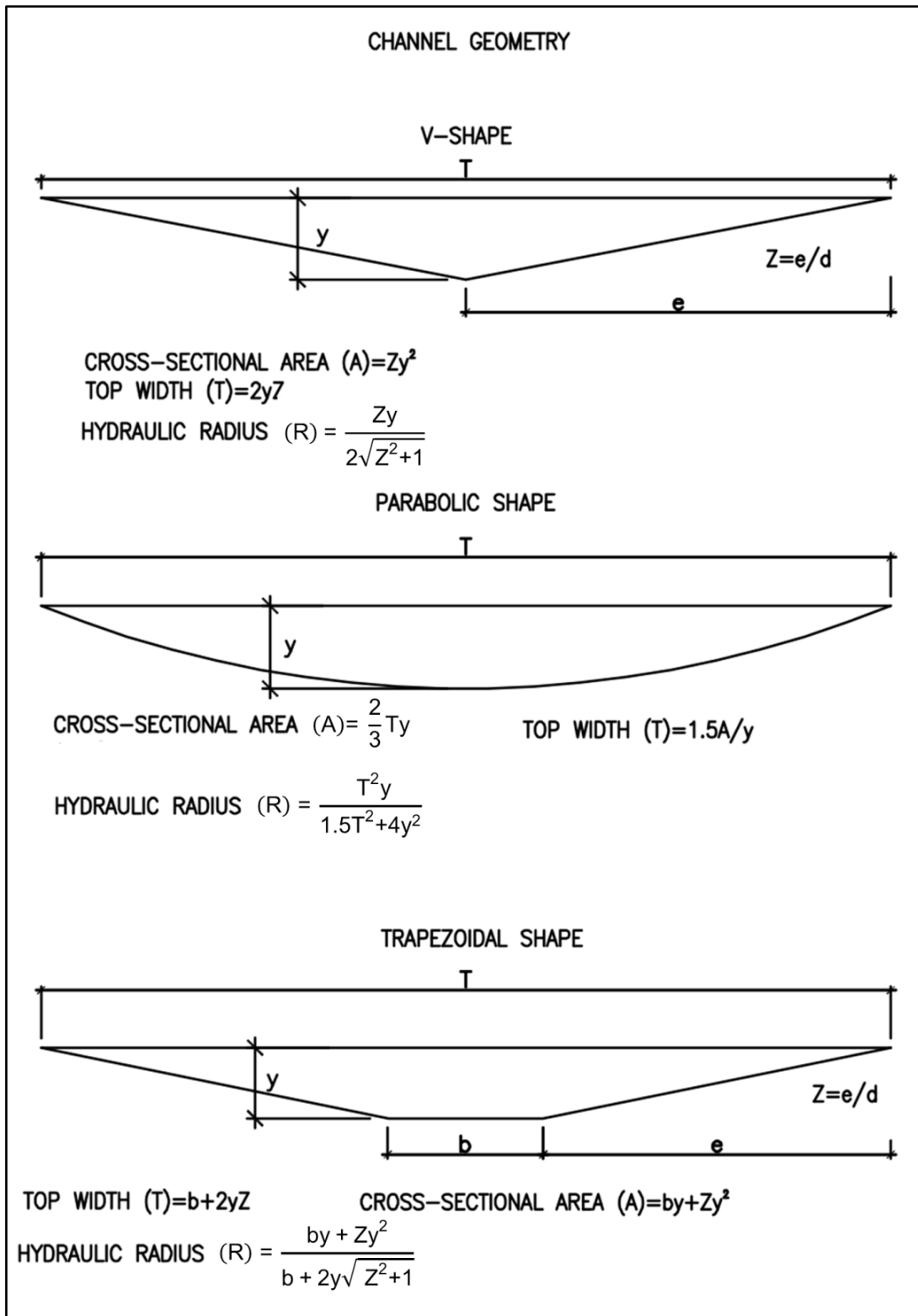
$$R_{\text{rectangle}} \approx y, \quad R_{\text{trapezoid}} \approx y, \quad R_{\text{parabolic}} \approx 0.67y, \quad R_v \approx 0.5y$$

Substitute  $R_{\text{trapezoid}}$  and  $A_{\text{trapezoid}} = by + Zy^2$  into Equation 4-1, and solve for the bottom width  $b$  (trapezoidal swale):

$$b \approx \frac{2.5Qn}{1.49y^{1.67}s^{0.5}} - Zy \quad \text{Equation 4-4}$$

For a trapezoid, select a side slope  $Z$  of at least 3. Compute  $b$  and then top width  $T$ , where  $T = b + 2yZ$ . (Note: Adjustment factor of 2.5 accounts for the differential between Water Quality design flow rate and the SBUH design flow. This equation is used to estimate an initial cross-sectional area. It does not affect the overall biofiltration swale size.)

If  $b$  for a swale is greater than 10 ft, either investigate how  $Q$  can be reduced, divide the flow by installing a low berm, or arbitrarily set  $b = 10$  ft and continue with the analysis. For other swale shapes refer to [Figure 4.21](#).



**Figure 4.21: Geometric Formulas for Common Swale Shapes**

(Source: redrawn from Livingston, et al, 1984)

- **D-5.** Compute A:

$$A_{\text{rectangle}} = Ty \quad \text{or} \quad A_{\text{trapezoid}} = by + Zy^2$$

$$A_{\text{filter strip}} = Ty$$

- **D-6.** Compute the flow velocity at design flow rate:

$$V = K \frac{Q}{A}$$

K = A ratio of the peak 10-minute flow predicted by SBUH to the water quality design flow rate estimated using the WWHM. The value of K is determined from [Figure 4.2](#) for on-line facilities, or [Figure 4.3](#) for off-line facilities.

If  $V > 1.0$  ft/sec (or  $V > 0.5$  ft/sec for a filter strip), repeat steps D-1 to D-6 until the condition is met. A velocity greater than 1.0 ft/sec was found to flatten grasses, thus reducing filtration. A velocity lower than this maximum value will allow a 9-minute hydraulic residence time criterion in a shorter biofilter. If the value of V suggests that a longer biofilter will be needed than space permits, investigate how Q can be reduced (e.g., use of low impact development BMPs), or increase y and/or T (up to the allowable maximum values) and repeat the analysis.

- **D-7.** Compute the swale length (L, ft)

$$L = Vt \text{ (60 sec/min)}$$

Where: t = hydraulic residence time (min)

Use t = 9 minutes for this calculation (use t = 18 minutes for a continuous inflow biofiltration swale). If a biofilter length is greater than the space permits, follow the advice in step D-6.

If a length less than 100 feet results from this analysis, increase it to 100 feet, the minimum allowed. In this case, it may be possible to save some space in width and still meet all criteria. This possibility can be checked by computing V in the 100 ft biofilter for t = 9 minutes, recalculating A (if  $V < 1.0$  ft/sec) and recalculating T.

- **D-8.** If there is still not sufficient space for the biofilter, the project proponent should consider the following solutions (listed in order of preference):
  1. Divide the site drainage to flow to multiple biofilters.
  2. Use infiltration to provide lower discharge rates to the biofilter (only if the Site Suitability Criteria in [Section 3.1.5.3](#) are met).
  3. Increase vegetation height and design depth of flow (note: the design must ensure that vegetation remains standing during design flow).
  4. Reduce the developed surface area to gain space for biofiltration.



5. Increase the longitudinal slope.
6. Increase the side slopes.
7. Nest the biofilter within or around another BMP.

#### Check for Stability (Minimizing Erosion)

The stability check must be performed for the combination of highest expected flow and least vegetation coverage and height. A check is not required for biofiltration swales that are located "off-line" from the primary conveyance/detention system. Maintain the same units as in the biofiltration capacity analysis.

- **SC-1.** Perform the stability check for the 100-year, return frequency flow using 15-minute time steps using an approved continuous flow model. Until WWHM peak flow rates in 15-minute time steps are available, use the WWHM 100-yr. hourly peak flows times with an adjustment factor of 1.6 to approximate peak flows in 15-minute time steps.
- **SC-2.** Estimate the vegetation coverage ("good" or "fair") and height on the first occasion that the biofilter will receive flow, or whenever the coverage and height will be least. Avoid flow introduction during the vegetation establishment period by timing planting or bypassing.
- **SC-3.** Estimate the degree of retardance from [Table 4.6](#). When uncertain, be conservative by selecting a relatively low degree.

The maximum permissible velocity for erosion prevention ( $V_{max}$ ) is 3 feet per second.

- **SC-4.** Select a trial Manning's  $n$  for the high flow condition. The minimum value for poor vegetation cover and low height (possibly, knocked from the vertical by high flow) is 0.033. A good initial choice under these conditions is 0.04.
- **SC-5.** Refer to [Figure 4.22](#), The Relationship of Manning's  $n$  with  $VR$ , to obtain a first approximation for  $VR$  of 3 feet/second
- **SC-6.** Compute hydraulic radius,  $R$ , from  $VR$  in [Figure 4.22](#) and  $V_{max}$ .
- **SC-7.** Use Manning's equation to solve for the actual  $VR$ .
- **SC-8.** Compare the actual  $VR$  from step SC-7 and first approximation from step SC-5. If they do not agree within 5 percent, repeat steps SC-4 to SC-8 until acceptable agreement is reached. If  $n < 0.033$  is needed to get agreement, set  $n = 0.033$ , repeat step SC-7, and then proceed to step SC-9.
- **SC-9.** Compute the actual  $V$  for the final design conditions: Check to be sure  $V < V_{max}$  of 3 feet/second.
- **SC-10.** Compute the required swale cross-sectional area,  $A$ , for stability:
- **SC-11.** Compare the  $A$ , computed in step SC-10 of the stability analysis, with the  $A$  from the biofiltration capacity analysis (step D-5).

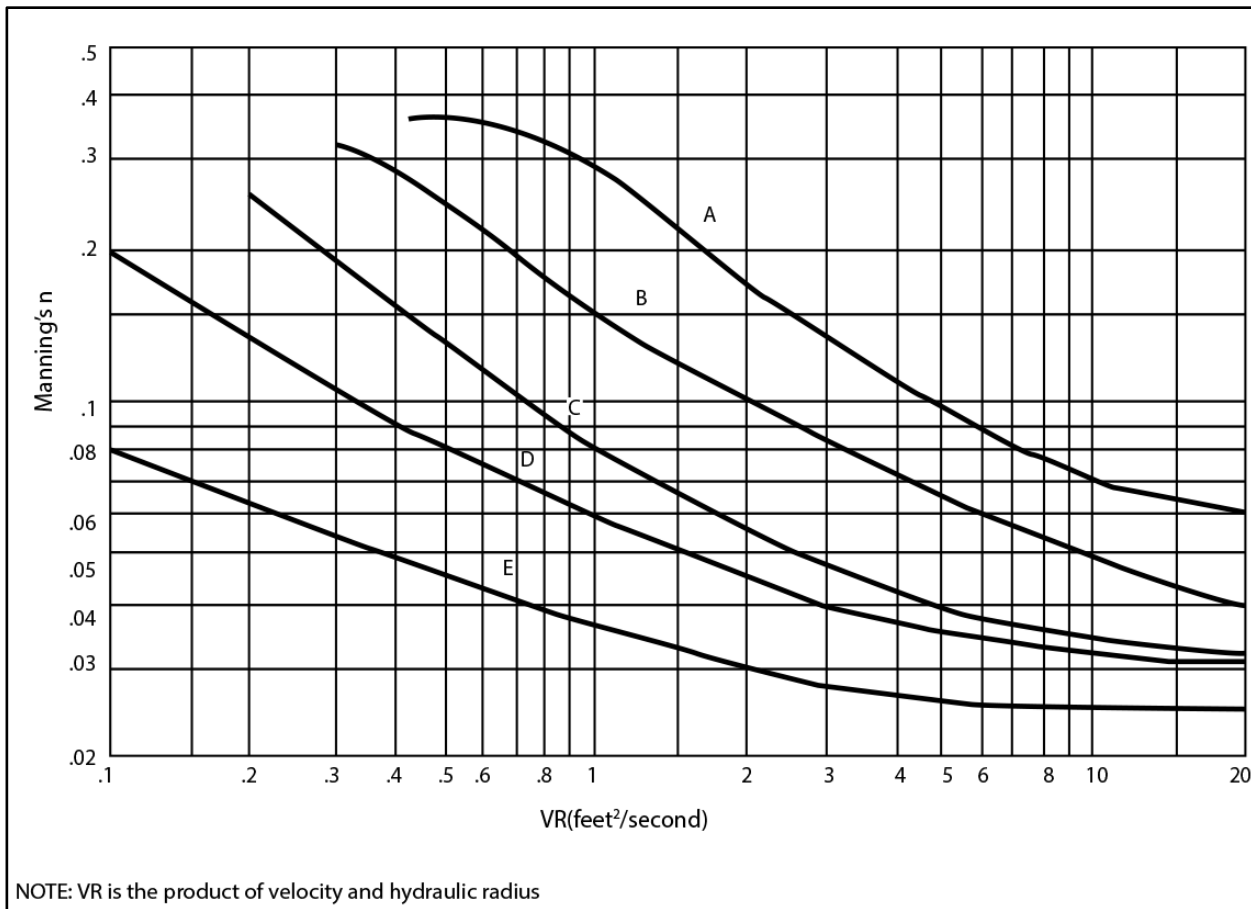
If less area is required for stability than is provided for capacity, the capacity design is acceptable. If not, use A from step SC-10 of the stability analysis and recalculate channel dimensions.

- **SC-12.** Calculate the depth of flow at the stability check design flow rate condition for the final dimensions and use A from step SC-10.
- **SC-13.** Compare the depth from step SC-12 to the depth used in the biofiltration capacity design (Step D-1). Use the larger of the two and add 0.5 ft. of freeboard to obtain the total depth ( $y_t$ ) of the swale. Calculate the top width for the full depth using the appropriate equation.
- **SC-14.** Recalculate the hydraulic radius: (use b from Step D-4 calculated previously for biofiltration capacity, or Step SC-11, as appropriate, and  $y_t$  = total depth from Step SC-13)
- **SC-15.** Make a final check for capacity based on the stability check design storm (this check will ensure that capacity is adequate if the largest expected event coincides with the greatest retardance). Use Equation 1, a Manning's n selected in step D-2, and the calculated channel dimensions, including freeboard, to compute the flow capacity of the channel under these conditions. Use R from step SC-14, above, and  $A = b(y_t) + Z(y_t)^2$  using b from Step D-4, D-15, or SC-11 as appropriate.

If the flow capacity is less than the stability check design storm flow rate, increase the channel cross-sectional area as needed for this conveyance. Specify the new channel dimensions.

**Table 4.6: Guide for Selecting Degree of Retardance**

<b>Coverage</b>	<b>Average Grass Height (inches)</b>	<b>Degree of Retardance</b>
Good	<2	E. Very Low
	2-6	D. Low
	6-10	C. Moderate
	11-24	B. High
	>30	A. Very High
Fair	<2	E. Very Low
	2-6	D. Low
	6-10	D. Low
	11-24	C. Moderate
	>30	B. High
<p><i>See Chow (1959). In addition, Chow recommended selection of retardance C for a grass-legume mixture 6-8 inches high and D for a mixture 4-5 inches high. No retardance recommendations have appeared for emergent wetland species. Therefore, judgment must be used. Since these species generally grow less densely than grasses, using a "fair" coverage would be a reasonable approach.</i></p>		



**Figure 4.22: Relationship of Manning's n with VR**

(Source: redrawn from Livingston, et al, 1984)

#### Completion Step (CO)

- **CO.** Review all of the criteria and guidelines for biofilter planning, design, installation, and operation above and specify all of the appropriate features for the application.

#### Soil Criteria

- The following top soil mix at least 8-inch deep:
  - Sandy loam 60-90 %
  - Clay 0-10 %
  - Composted organic matter, 10-30 %  
(excluding animal waste, toxics)

Use compost amended soil where practicable. Composted material shall meet the specifications for compost used in the Bioretention Soil Media ([BMP 4.7.30](#) [5.14B](#)). This excludes use of biosolids and manures.

- Till to at least 8-inch depth

- For longitudinal slopes of < 2 percent use more sand to obtain more infiltration
- If groundwater contamination is a concern, seal the bed with clay or a geomembrane liner

### Vegetation Criteria

See [Table 4.7](#) and [Table 4.8](#) for recommended grasses and groundcovers.

- Grass must be fine, turf-forming, water-resistant grasses where vegetative growth and moisture will be adequate for growth.
- Irrigate if moisture is insufficient during dry weather season.
- Use sod with low clay content and where needed to initiate adequate vegetative growth. Preferably sod should be laid to a minimum of one-foot vertical depth above the swale bottom.
- Consider sun/shade conditions for adequate vegetative growth. Shade tolerant vegetation must be used when prolonged shading of any portion will occur.
- Stabilize soil areas upslope of the biofilter to prevent erosion
- Fertilizing a biofilter should be avoided if at all possible in any application where nutrient control is an objective. Test the soil for nitrogen, phosphorous, and potassium and consult with a landscape professional about the need for fertilizer in relation to soil nutrition and vegetation requirements. If use of a fertilizer cannot be avoided, use a slow-release fertilizer formulation in the least amount needed.

**Table 4.7: Grass Seed Mixes Suitable for Biofiltration Swale Treatment Areas**

<b>Bioswale Dry Soil Conditions</b>		
<u>Botanical Name</u>	<u>Common Name</u>	<u>% By Weight</u>
<i>Elymus glaucus</i>	blue wildrye	50.00%
<i>Agrostis exerata</i>	spike bentgrass	10.00%
<i>Bromus carinatus</i>	California brome	10.00%
<i>Festuca idahoensis</i>	Idaho fescue	30.00%
<b>Bioswale Wet or Dry Soil Conditions</b>		
<u>Botanical Name</u>	<u>Common Name</u>	<u>%By Weight</u>
<i>Elymus glaucus</i>	blue wildrye	60.00%
<i>Hordeum brachyantherum</i>	meadow barley	30.00%
<i>Bromus carinatus</i>	California brome	10.00%
<b>Bioswale Wet Soil Conditions</b>		
<u>Botanical Name</u>	<u>Common Name</u>	<u>% By Weight</u>
<i>Agrostis exerata</i>	spike bentgrass	0.50%
<i>Deschampsia cespitosa</i>	tufted hairgrass	2.50%
<i>Glyceria occidentalis</i>	western mannagrass	25.00%
<i>Juncus effusus</i>	soft rush	8.00%
<i>Beckmannia syzigachne</i>	slough grass	4.00%
<i>Alopecurus geniculatus</i>	water foxtail	15.00%
<i>Hordeum brachyantherum</i>	meadow barley	45.00%
<p>Selected plants shall not include any plants from the State of Washington Noxious Weed List. Refer to <a href="http://www.clark.wa.gov/environmental-services/vegetation-management">www.clark.wa.gov/environmental-services/vegetation-management</a> for a current list of noxious weeds.</p>		

**Table 4.8: Groundcovers and Grasses Suitable for Upper Side Slopes of a Swale**

<b>Groundcovers</b>	
<u>Botanical Name</u>	<u>Common Name</u>
<i>Arctostaphylos uva-ursi</i>	kinnikinnick
<i>Fragaria chiloensis</i>	strawberry
<i>Lupinus latifolius</i>	broadleaf lupine
<b>Grasses (drought-tolerant, minimum mowing)</b>	
<u>Botanical Name</u>	<u>Common Name</u>
<i>Festuca spp. (e.g., Many Mustang, Silverado)</i>	dwarf tall fescues
<i>Festuca ovina duriuscula (e.g., Reliant, Aurora)</i>	hard fescue
<i>Festuca amethystine</i>	tufted fescue
<i>Buchloe dactyloides</i>	buffalo grass
<i>Festuca rubra</i>	red fescue
<i>Festuca arundinacea</i>	tall fescue grass
<i>Helictotrichon sempervirens</i>	blue oatgrass
Selected plants shall not include any plants from the State of Washington Noxious Weed List. Refer to <a href="http://www.clark.wa.gov/environmental-services/vegetation-management">www.clark.wa.gov/environmental-services/vegetation-management</a> for a current list of noxious weeds.	

## Construction Criteria

The biofiltration swale should not be put into operation until areas of exposed soil in the contributing drainage catchment have been stabilized. Deposition of eroded soils can impede the growth of grass in the swale and reduce swale treatment effectiveness. The cost to restore a swale damaged by sediment deposition will be borne by the project or swale owner. Thus, effective erosion and sediment control measures should remain in place until the swale vegetation is established (see [Book 1, Section 6.5](#) for selection of erosion and sediment control BMPs). Avoid compaction during construction. Grade biofilters to attain uniform longitudinal and lateral slopes.

## BMP T9.20: Wet Biofiltration Swale

---

### Purpose and Description

A wet biofiltration swale is a variation of a basic biofiltration swale used when the longitudinal slope is slight, water tables are high, or a continuous low base flow is likely to result in saturated soil. Where saturation exceeds about 2 weeks, typical grasses will die. Thus, use vegetation specifically adapted to saturated soil conditions. The use of wetland plants instead of grass requires modification of several of the design parameters for the basic biofiltration swale.

### Cross Reference Guide

Soils Assessment	None
Minimum Requirements/ Treatment Type	MR #6 Meets Basic; Meets Enhanced and Phosphorus as part of a treatment train
Related BMPs	<a href="#">BMP T8.10</a> (Enhanced or Phosphorus), <a href="#">BMP T8.20</a> (Enhanced or Phosphorus), or <a href="#">BMP T8.40</a> (Enhanced) for a treatment train.
Selection/Infeasibility Criteria	<a href="#">Book 1, Section 3.2 and Section 3.4.4</a>
Maintenance	<a href="#">Book 4</a>

### Application, Limitations and Setbacks

Wet biofiltration swales are applied where a basic biofiltration swale is desired but not allowed or advisable because one or more of the following conditions exist:

- The swale is on clay (till) soils and is downstream of a detention pond providing flow control.
- Saturated soil conditions are likely because of seeps or base flows on the site.
- Longitudinal slopes are slight (generally less than 2 percent).
- The swale is part of a treatment train.

#### Setbacks

See [Section 3.1.4](#).

### Design Criteria

Use the same design approach as for basic biofiltration swales except add the following:



- **Adjust for extended wet season flow.** If the swale will be downstream of a detention pond providing flow control, multiply the treatment area (bottom width times length) of the swale by 2, and readjust the swale length, if desired. Maintain a 5:1 length to width ratio.

Intent: An increase in the treatment area of swales following detention ponds is required because of the differences in vegetation established in a constant flow environment. Flows following detention are much more prolonged. These prolonged flows result in more stream-like conditions. Since vegetation growing in streams is often less dense, this increase in treatment area is needed to ensure that equivalent pollutant removal is achieved in extended flow situations.

- **Swale Geometry.** Use the same geometry as specified for basic biofiltration swales except for the following modifications:
  - **Criterion 1:** The bottom width may be increased to 25 feet maximum, but a minimum length-to-width ratio of 5:1 must be provided. No longitudinal dividing berm is needed. The minimum swale length is still 100 feet.
  - **Criterion 2:** If longitudinal slopes are greater than 2 percent, the wet swale must be stepped so that the slope within the stepped sections averages 2 percent. Steps may be made of retaining walls, log check dams, or short riprap sections. No underdrain or low-flow drain is required.
- **High-Flow Bypass.** A high-flow bypass (i.e., an off-line design) is required for flows greater than the off-line water quality design flow that has been increased by the ratio indicated in [Figure 4.3](#). The bypass is necessary to protect wetland vegetation from damage. Unlike grass, wetland vegetation will not quickly regain an upright attitude after being laid down by high flows. New growth, usually from the base of the plant, often taking several weeks, is required to regain its upright form. The bypass may be an open channel parallel to the wet biofiltration swale.
- **Water Depth and Base Flow.** Use the same depth and base flow as for basic biofiltration swales except the design water depth shall be 4 inches for all wetland vegetation selections, and no underdrains or low-flow drains are required.
- **Flow Velocity, Energy Dissipation, and Flow Spreading.** Use the same calculations as for basic biofiltration swales except no flow spreader is needed.
- **Access.** Use the same access as for basic biofiltration swales except access is only required to the inflow and the outflow of the swale; access along the length of the swale is not required. Also, wheel strips may not be used for access in the swale.
- **Soil Amendment.** Same as for basic biofiltration swales.
- **Planting Requirements.** Same as for basic biofiltration swales except for the following modifications:
- **Side slopes:** See [Section 3.1.4](#).

1. A list of acceptable plants and spacing is shown in [Table 4.9](#). In general, it is best to plant several species to increase the likelihood that at least some of the selected species will find growing conditions favorable.
  2. A wetland seed mix may be applied by hydroseeding, but if coverage is poor, planting of rootstock or nursery stock is required. Poor coverage is considered to be more than 30 percent bare area through the upper 2/3 of the swale after four weeks.
- **Recommended Design Features.** Same as for basic biofiltration swales
  - **Construction Considerations.** Same as for basic biofiltration swales
  - **Maintenance Considerations.** Same as for basic biofiltration swales except mowing of wetland vegetation is not required. However, harvesting of very dense vegetation may be desirable in the fall after plant die-back to prevent the sloughing of excess organic material into receiving waters. Many native *Juncus* species remain green throughout the winter; therefore, fall harvesting of *Juncus* species is not recommended.

Table 4.9: Acceptable Plants for Wet Biofiltration Swale

<b>Wet Biofiltration Swale Treatment Area</b>		
<u>Botanical Name</u>	<u>Common Name</u>	<u>O.C. Spacing</u>
<i>Alopecurus aequalis</i>	Shortawn foxtail	seed
<i>Alopecurus geniculatus</i>	Water foxtail	seed
<i>Eleocharis ovata</i>	Spike rush	4 inches or seed
<i>Carex stipata</i>	Sawbeak sedge	6 inches
<i>Carex obnupta</i>	Slough Sedge	6 inches
<i>Glyceria occidentalis</i>	Western mannagrass	seed
<i>Holcus mollis</i>	Velvetgrass	seed
<i>Juncus tenuis</i>	Slender rush	6 inches
<i>Oenanthe sarmentosa</i>	Water parsley*	6 inches
<i>Scirpus acutus</i>	Hardstem bulrush	6 inches
<i>Scirpus microcarpus</i>	Small-fruited bulrush	12 inches
<i>Juncus effusus</i>	Soft rush	18 inches
<i>Juncus oxymeris</i>	Pointed rush	12 inches
<i>Juncus ensifolius</i>	Dagger leaf rush	12 inches
<p>Selected plants shall not include any plants from the State of Washington Noxious Weed List. Refer to <a href="http://clarkwa.gov/weed/">clarkwa.gov/weed/</a> for a current list of noxious weeds.</p> <p>*Good choices for swales with significant periods of flow, such as those downstream of a detention facility.</p> <p>Note: Cattail (<i>Typha latifolia</i>) is not appropriate for most wet swales because of its very dense and clumping growth habit which prevents water from filtering through the clump.</p>		

## BMP T9.30: Continuous Inflow Biofiltration Swale

---

### Purpose and Description

In situations where water enters a biofiltration swale continuously along the side slope rather than discretely at the head, the continuous inflow biofiltration swale is needed. The basic swale design is modified by increasing swale length to achieve an equivalent average residence time.

### Cross Reference Guide

Soils Assessment	None
Minimum Requirements/ Treatment Type	MR #6 Meets Basic; Meets Enhanced and Phosphorus as part of a treatment train
Related BMPs	<a href="#">BMP T8.10</a> (Enhanced or Phosphorus), <a href="#">BMP T8.20</a> (Enhanced or Phosphorus), or <a href="#">BMP T8.40</a> (Enhanced) for a treatment train.
Selection/Infeasibility Criteria	<a href="#">Book 1, Section 3.2 and Section 3.4.4</a>
Maintenance	<a href="#">Book 4</a>

### Application, Limitations and Setbacks

A continuous inflow biofiltration swale is to be **used when inflows are not concentrated**, such as locations along the shoulder of a road without curbs. This design may also be **used where frequent, small point flows enter a swale**, such as through curb inlet ports spaced at intervals along a road, or from a parking lot with frequent curb cuts. In general, no inlet port should carry more than about 10 percent of the flow.

A continuous inflow swale is not appropriate for a situation in which significant lateral flows enter a swale at some point downstream from the head of the swale. In this situation, the swale width and length must be recalculated from the point of confluence to the discharge point in order to provide adequate treatment for the increased flows.

#### Setbacks

See [Section 3.1.4](#).

#### Design Criteria

Same as specified for **basic biofiltration swale** except for the following:

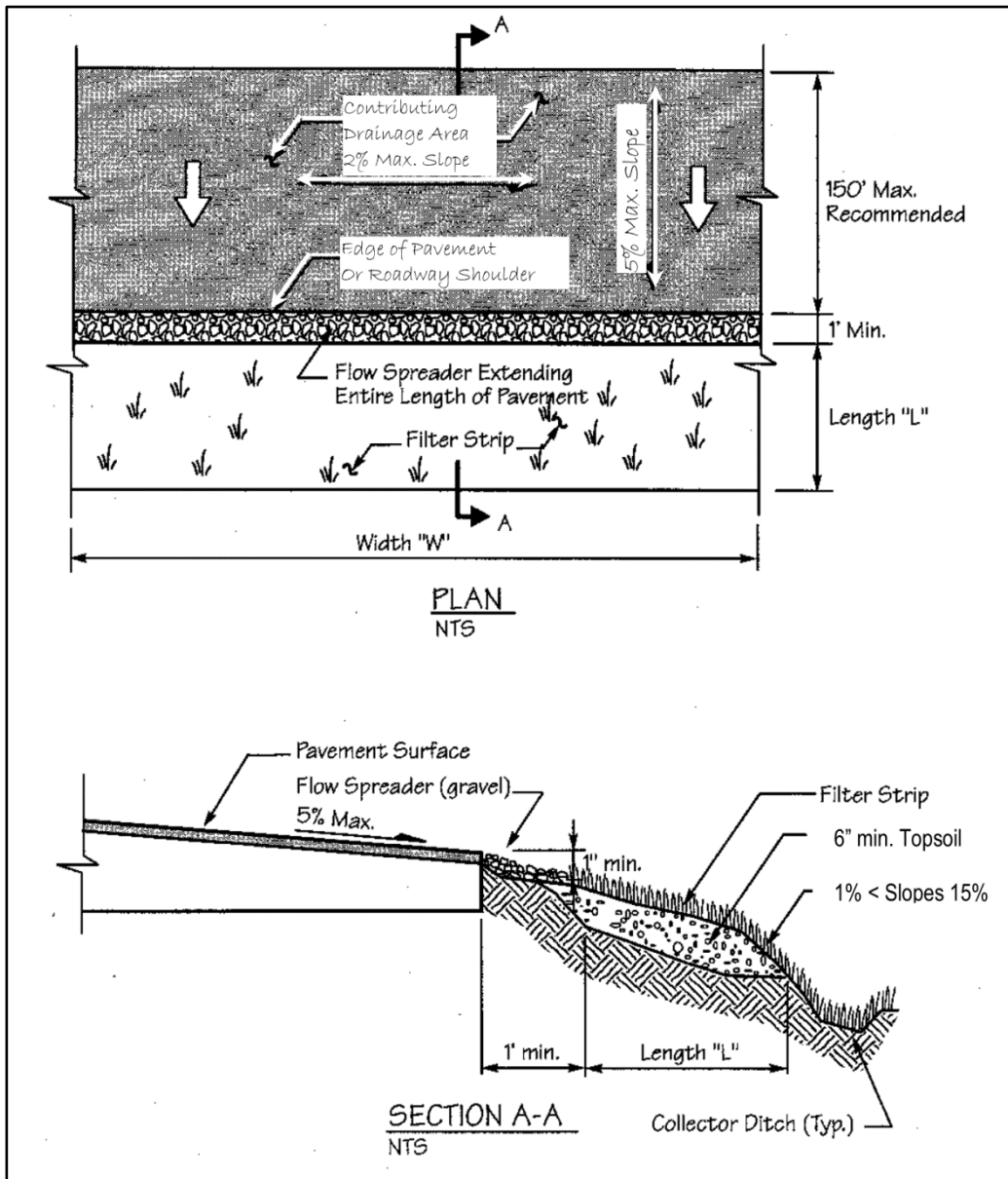
- The design flow for continuous inflow swales must include runoff from the pervious side slopes draining to the swale along the entire swale length. Therefore, they must be on-line facilities.
- If only a single design flow is used, the flow rate at the outlet should be used. The goal is to achieve an average residence time through the swale of 9 minutes as calculated using the on-line water quality design flow rate multiplied by the ratio, K, in [Figure 4.2](#). Assuming an even distribution of inflow into the side of the swale double the hydraulic residence time to a minimum of 18 minutes.
- For continuous inflow biofiltration swales, interior side slopes above the WQ design treatment elevation shall be planted in grass. A typical lawn seed mix or the biofiltration seed mixes are acceptable. Landscape plants or groundcovers other than grass may not be used anywhere between the runoff inflow elevation and the bottom of the swale.
- See [Section 3.1.4](#) for additional sideslope information.

Intent: The use of grass on interior side slopes reduces the chance of soil erosion and transfer of pollutants from landscape areas to the biofiltration treatment area.

## BMP T9.40: Basic Filter Strip

### Purpose and Description

A basic filter strip is flat with no side slopes. Contaminated stormwater is distributed as sheet flow across the inlet width of a biofilter strip. Treatment is by passage of water over the surface and through grass.



**Figure 4.23: Typical Filter Strip**

(Source: WA State Dept. of Ecology)

## Cross Reference Guide

Soils Assessment	None
Minimum Requirements/ Treatment Type	MR #6 Meets Basic; Meets Enhanced and Phosphorus as part of a treatment train
Related BMPs	<a href="#">BMP T8.30</a> for a treatment train.
Selection/Infeasibility Criteria	<a href="#">Book 1, Section 3.2 and Section 3.4.4</a>
Maintenance	<a href="#">Book 4</a>

## Application, Limitations and Setbacks

The basic filter strip is typically used on-line and adjacent and parallel to a paved area such as parking lots, driveways, and roadways.

### Setbacks

See [Section 3.1.4](#).

### Design Criteria

- Use the Design Criteria specified in [Table 4.10](#).
- See [Section 3.1.4](#) for sideslope information.
- Filter strips should only receive sheet flow.
- Use curb cuts  $\geq$  12-inch wide and 1-inch above the filter strip inlet.

Calculate the design flow depth using Manning's equation as follows:

$$KQ = (1.49A R^{0.67} s^{0.5})/n$$

Substituting for AR:

$$KQ = (1.49Ty^{1.67} s^{0.5})/n$$

Where:

- $Ty = A_{\text{rectangle, ft}}^2$
- $y \approx R_{\text{rectangle}}$ , design depth of flow, ft. (1 inch maximum)
- $Q$  = peak Water Quality design flow rate based on WWHM,  $\text{ft}^3/\text{sec}$
- $K$  = The ratio determined by using [Figure 4.2](#).

- $n$  = Manning's roughness coefficient
- $s$  = Longitudinal slope of filter strip parallel to direction of flow
- $T$  = Width of filter strip perpendicular to the direction of flow, ft.
- $A$  = Filter strip inlet cross-sectional flow area (rectangular), ft<sup>2</sup>
- $R$  = hydraulic radius, ft.

Rearranging for  $y$ :

$$y = [KQn/1.49Ts^{0.5}]^{0.6} \quad y \text{ must not exceed 1 inch}$$

Note: As in swale design an adjustment factor of  $K$  accounts for the differential between the WWHM Water Quality design flow rate and the SBUH design flow.

Calculate the design flow velocity  $V$ , ft./sec., through the filter strip:

$$V = KQ/Ty \quad V \text{ must not exceed 0.5 ft./sec}$$

Calculate required length, ft., of the filter strip at the minimum hydraulic residence time,  $t$ , of 9 minutes:

$$L = tV = 540V$$

**Table 4.10: Filter Strip Sizing Criteria**

Design parameter	
Longitudinal Slope	0.01 - 0.33
Maximum velocity	0.5 ft / sec @ $K$ multiplied by the WQ design flow rate
Maximum water depth <sup>(1)</sup>	1-inch max.
Manning coefficient (22)	0.35
Minimum hydraulic residence time at Water Quality Design Flow Rate	9 minutes
Minimum length	Sufficient to achieve hydraulic residence time in the filter strip
Maximum sideslope	Inlet edge $\geq$ 1" lower than contributing paved area
Max. tributary drainage flow path	150 feet
Max. longitudinal slope of contributing area	0.05 (steeper than 0.05 need upslope flow spreading and energy dissipation)
Max. lateral slope of contributing area	0.02 (at the edge of the strip inlet)

(1) Below the design water depth install an erosion control blanket, at least 4" of topsoil, and the selected biofiltration mix. Above the water line use a straw mulch or sod.



## BMP T7.40: Compost-Amended Vegetated Filter Strips (CAVFS)

---

### Purpose and Description

A basic filter strip is flat with no side slopes. Contaminated stormwater is distributed as sheet flow across the inlet width of a biofilter strip. Treatment is by passage of water over the surface, and through grass.

The CAVFS is a variation of the basic vegetated filter strip ([BMP T9.40](#)) that adds soil amendments to the roadside embankment. The soil amendments improve infiltration characteristics, increase surface roughness, and improve plant sustainability. Once permanent vegetation is established, CAVFS BMPs have several advantages:

- higher surface roughness
- greater retention and infiltration capacity.
- improved removal of soluble cationic contaminants through sorption.
- improved overall vegetative health.
- reduction of invasive weeds.

Compost-amended systems have somewhat higher construction costs due to more expensive materials, but require less land area for runoff treatment, which can reduce overall costs. These BMPs are typically used on-line and adjacent and parallel to a paved area such as parking lots, driveways, and roadways.

### Cross Reference Guide

Soils Assessment	None
Minimum Requirements	MR #6, Enhanced
Related BMPs	None
Selection/Infeasibility Criteria	<a href="#">Book 1, Section 3.2 and Section 3.4.4</a>
Maintenance	<a href="#">Book 4</a>

### Application, Limitations, and Setbacks

CAVFS can be used to meet basic runoff treatment and enhanced runoff treatment objectives and have practical application in areas where there is space for roadside embankments that can be built to the CAVFS specifications.



**Figure 4.24: Compost-amended Vegetated Filter Strip Photo**

(Source: WSDOT Highway Runoff Manual)

### Setbacks

See [Section 3.1.4](#).

### Design Criteria

The CAVFS design incorporates composted material into the native soils per the criteria in [BMP T5.13](#) for turf areas. However, as noted below, the compost shall not contain biosolids, or manure. The goal is to create a healthy soil environment for a lush growth of turf.

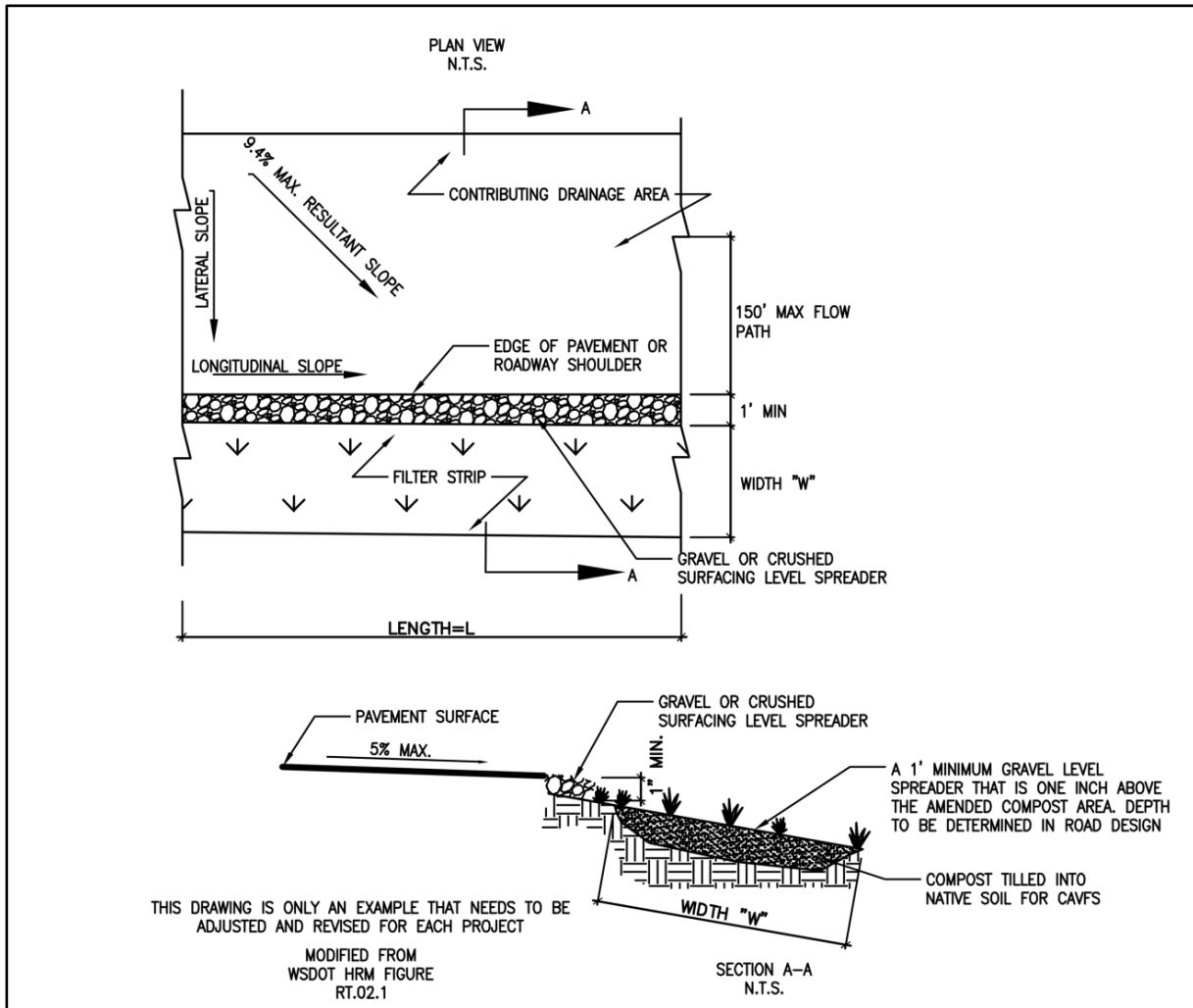
### General Recommendations

- Longitudinal slope: 1-33%.
- Maximum velocity: 0.5 feet per second.
- Maximum water depth: 1 inch.
- Manning coefficient: 0.35.
- Minimum hydraulic residence time at the design flow rate: 9 minutes.
- Inlet edge at least 1 inch lower than contributing paved area.
- Maximum tributary drainage flow path: 150 feet.
- Maximum longitudinal slope of contributing area: 0.05.
- With steeper slopes, energy dissipation and flow spreading is needed.
- Maximum lateral slope of contributing area: 2% (at the edge of the inlet to the strip).

### Soil/Compost Mix

- Presumptive approach: Place and rototill 1.75 inches of composted material into 6.25 inches of soil (a total amended depth of about 9.5 inches), for a settled depth of 8 inches. Water or roll to compact soil to a maximum of 85% Standard Proctor. Plant grass.
- Custom approach: Place and rototill the calculated amount of composted material into a depth of soil needed to achieve 8 inches of settled soil at 5% organic content. Water or roll to compact soil to a maximum of 85% Standard Proctor. Plant grass. The amount of compost or other soil amendments used varies by soil type and organic matter content. If site soils already have relatively high organic content, then it may be possible to modify the pre-approved rate described above and still achieve the 5% organic content target.
- The final soil should have an initial saturated hydraulic conductivity less than 12 inches per hour and minimum long-term hydraulic conductivity of 1 inch per hour per ASTM Designation D 2434 (Standard Test Method for Permeability of Granular Soils) at 85% compaction per ASTM Designation D 1557 (Standard Test Method for Laboratory Compaction Characteristics of Soil Using Modified Effort. Infiltration rate and hydraulic conductivity are assumed to be approximately the same in a uniform mix soil. Note: Long term saturated hydraulic conductivity is determined by applying the appropriate infiltration correction factors as explained under “Determining Bioretention soil mix infiltration rate” under [BMP 5.14B](#).
- The final soil mixture should have a minimum organic content of 5% by dry weight per ASTM Designation D 2974 (Standard Test Method for Moisture, Ash and Organic Matter of Peat and Other Organic Soils) (Tackett, 2004).
- Achieving the above recommendations will depend on the specific soil and compost characteristics. In general, the above recommendations can be achieved with 60% to 65% loamy sand mixed with 25% to 30% compost or 30% sandy loam, 30% coarse sand, and 30% compost.
- The final soil mixture should be tested prior to installation for fertility, micronutrient analysis, and organic material content.
- Clay content for the final soil mix should be less than 5%.
- Compost must not contain biosolids, any street or highway sweepings, or any catch basin solids.
- The pH for the soil mix should be between 5.5 and 7.0
  - If the pH falls outside the acceptable range, it may be modified with lime to increase the pH or iron sulfate plus sulfur to lower the pH. The lime or iron sulfate must be mixed uniformly into the soil prior to use in LID areas.
- The soil mix should be uniform and free of stones, stumps, roots, or other similar material larger than 2 inches.
- When placing topsoil, it is important that the first lift of topsoil is mixed into the top of the existing soil. This allows the roots to penetrate the underlying soil easier and helps prevent the formation of a slip plane between the two soil layers.
- The soil component of the mix should be loamy sand by the USDA soil texture classification

- The compost component should conform to the same classifications as those for the compost in [BMP 17.30 5.14B](#) bioretention.



**Figure 4.25: Compost Amended Vegetated Filter Strip Typical**

(Source: redrawn from Highway Runoff Manual)

## Runoff Modeling Representation

- The CAVFS will have an “Element” in the approved continuous flow models that must be used for determining the amount of water that is treated by the CAVFS. To fully meet treatment requirements, 91 percent of the influent runoff file must pass through the soil profile of the CAVFS. Water that merely flows over the surface is not considered treated. Approved continuous flow models should be able to report the amount of water that it estimates will pass through the soil profile.

## BMP T10.10: Wetponds - Basic and Large

---

### Purpose and Description

A wetpond is a constructed stormwater pond that retains a permanent pool of water ("wetpool") at least during the wet season. The volume of the wetpool is related to the effectiveness of the pond in settling particulate pollutants. As an option, a shallow marsh area can be created within the permanent pool volume to provide additional treatment for nutrient removal. Peak flow control can be provided in the "live storage" area above the permanent pool (see [section 6.1](#) for detention facility design).

The following design, construction, and operation and maintenance criteria cover two wetpond applications - the basic wetpond and the large wetpond. Large wetponds are designed for higher levels of pollutant removal.

### Cross Reference Guide

Soils Assessment	None
Minimum Requirements/ Treatment Type	MR #6 Basic Wetpond meets Basic treatment criteria, or meets Enhanced and phosphorus treatment as part of a treatment train; Large wetpond meets phosphorus treatment requirements
Related BMPs	<a href="#">BMPs T8.10</a> , <a href="#">T8.20</a> , or <a href="#">T8.40</a> (with media approved for basic or enhanced treatment) for a treatment train.
Selection/Infeasibility Criteria	<a href="#">Book 1, Section 3.2 and Section 3.4.5</a>
Maintenance	<a href="#">Book 4</a>

### Application, Limitations and Setbacks

A wetpond requires a larger area than a biofiltration swale or a sand filter, but it can be integrated to the contours of a site fairly easily. In soils that do not infiltrate, the wetpond holds a permanent pool of water that provides an attractive aesthetic feature. In more porous soils, wetponds may still be used, but water seepage from unlined cells could result in a dry pond, particularly in the summer months. Lining the first cell with a low permeability liner is one way to deal with this situation. As long as the first cell retains a permanent pool of water, this situation will not reduce the pond's effectiveness, but may be an aesthetic drawback.

Wetponds work best when the water already in the pond is moved out en masse by incoming flows, a phenomenon called "plug flow. Because treatment works on this displacement principle, the wetpool storage of wetponds may be provided below the groundwater level without interfering unduly with treatment effectiveness. However, if combined with a detention function, the live storage must be above the seasonal high groundwater level.

Wetponds may be single-purpose facilities, providing only runoff treatment, or they may be combined with a detention pond to also provide flow control. If combined, the wetpond can often be stacked under the detention pond with little further loss of development area. See [BMP D6.40](#) for a description of combined detention and wetpool facilities.

### Setbacks

- All facilities shall be a minimum of 20 feet from any structure, property line, and any critical area buffer, and 100 feet from any septic tank/drainfield.
- All facilities shall be a minimum of 50 feet from any steep (greater than 15 percent) slope. A geotechnical report must address the potential impact of a wet pond on a steep slope.
- Access and maintenance roads shall be provided and designed according to the requirements for detention ponds. Access and maintenance roads shall extend to both the wetpond inlet and outlet structures. An access ramp (7H minimum:1V) shall be provided to the bottom of the first cell unless all portions of the cell can be reached and sediment loaded from the top of the pond.
- If the dividing berm is also used for access, it should be built to sustain loads of up to 80,000 pounds.

### Design Criteria

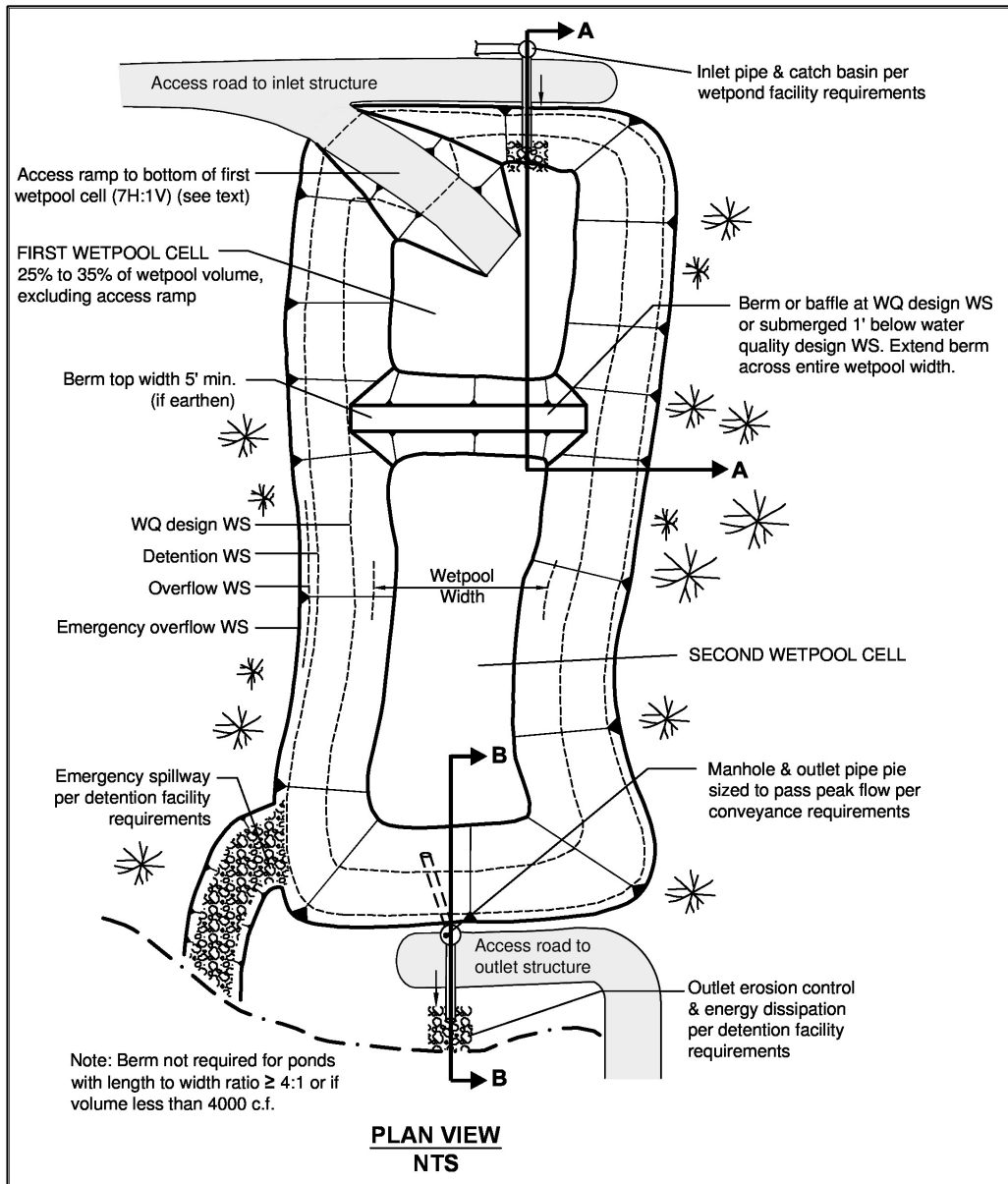
The primary design factor that determines a wetpond's treatment efficiency is the volume of the wetpool. The larger the wetpool volume, the greater the potential for pollutant removal.

For a basic wetpond, the wetpool volume provided shall be equal to or greater than the total volume of runoff from the water quality design storm or the Water Quality Design Storm – the 6 month, 24-hour storm event. Alternatively, use an approved continuous flow model to provide the water quality volume. This volume is equal to the simulated daily volume that represents the upper limit of the range of daily volumes that accounts for 91% of the entire runoff volume over a multi-decade period of record.

A large wetpond requires a wetpool volume at least 1.5 times larger than the Water Quality Design Storm Volume. Also important are the avoidance of short-circuiting and the promotion of plug flow. To prevent short-circuiting, water is forced to flow, to the extent practical, to all potentially available flow routes, avoiding "dead zones" and maximizing the time water stays in the pond during the active part of a storm.

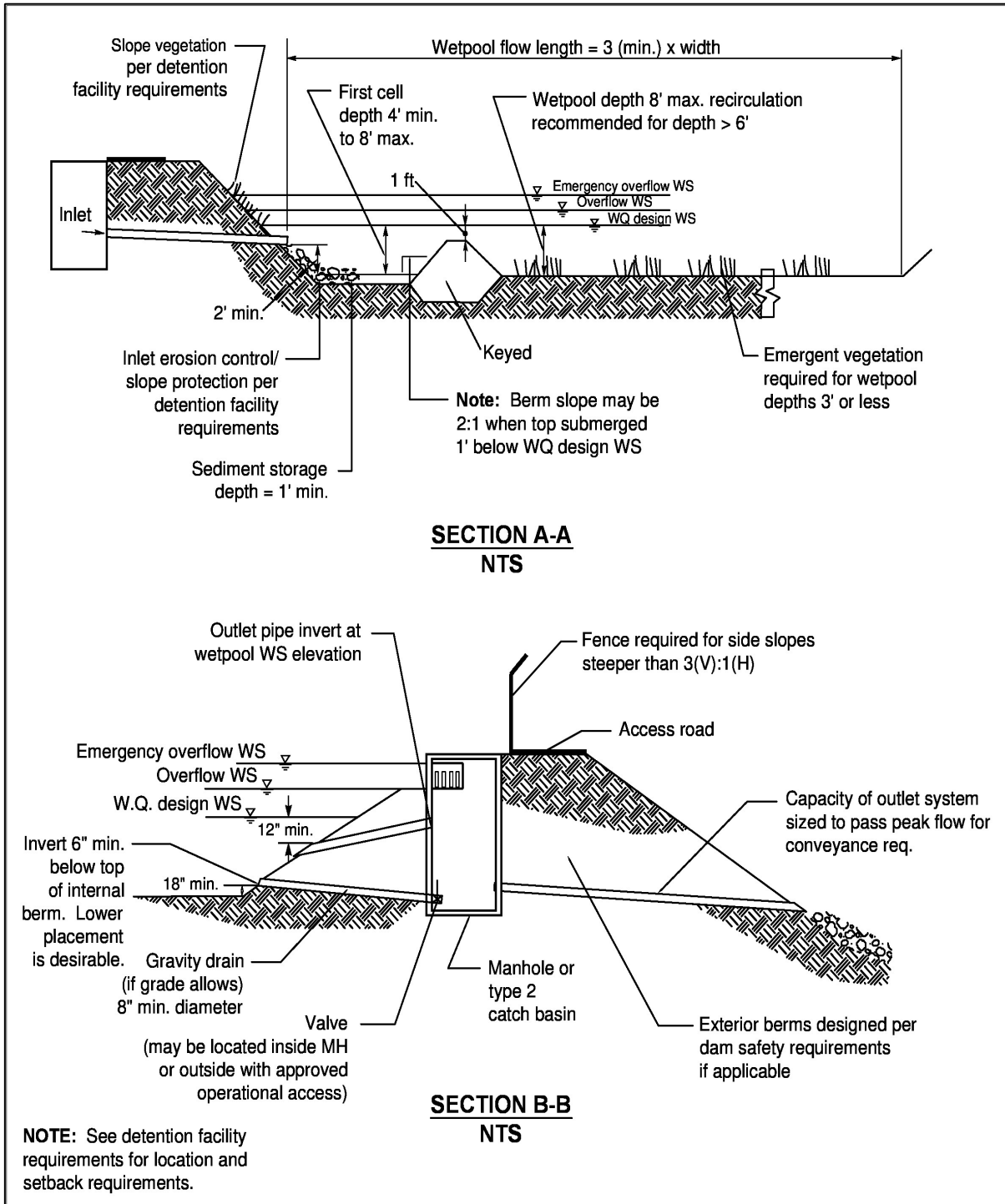
Design features that encourage plug flow and avoid dead zones are:

- Dissipating energy at the inlet.
- Providing a large length-to-width ratio.
- Providing a broad surface for water exchange using a berm designed as a broad-crested weir to divide the wetpond into two cells rather than a constricted area such as a pipe.
- Maximizing the flow path between inlet and outlet, including the vertical path, also enhances treatment by increasing residence time.



**Figure 4.26: Wetpond - Plan View**

(Source: WA State Dept. of Ecology)



**Figure 4.27: Wetpond - Section View**

(Source: WA State Dept. of Ecology)



## Sizing Procedure

- **Step 1:** Identify required wetpool volume. A basic wetpond requires a volume equal to or greater than the total volume of runoff from the 6-month, 24-hour storm event or the Water Quality Design Storm Volume indicated by an approved continuous flow model. A large wetpond requires a volume at least 1.5 times the total volume of runoff from the 6-month, 24-hour storm event or the Water Quality Design Storm Volume identified by an approved continuous flow model.
- **Step 2:** Determine wetpool dimensions. Determine the wetpool dimensions satisfying the design criteria outlined below and illustrated in [Figure 4.26 and 4.27](#) and ~~4.28~~. A simple way to check the volume of each wetpool cell is to use the following equation:

$$V = \frac{h(A_1 + A_2)}{2}$$

Where:

- $V$  = wetpool volume (cf)
  - $h$  = wetpool average depth (ft)
  - $A_1$  = water quality design surface area of wetpool (sf)
  - $A_2$  = bottom area of wetpool (sf)
- **Step 3:** Design pond outlet pipe and determine primary overflow water surface. The pond outlet pipe shall be placed on a reverse grade from the pond's wetpool to the outlet structure.
  - **Step 4:** Determine wetpond dimensions.

## Wetpool Geometry

- The wetpool shall be divided into two cells separated by a baffle or berm. The first cell shall contain between 25 to 35 percent of the total wetpool volume. The baffle or berm volume shall not count as part of the total wetpool volume. The term baffle means a vertical divider placed across the entire width of the pond, stopping short of the bottom. A berm is a vertical divider typically built up from the bottom, or if in a vault, connects all the way to the bottom.

Intent: The full-length berm or baffle promotes plug flow and enhances quiescence and laminar flow through as much of the entire water volume as possible. Alternative methods to the full-length berm or baffle that provide equivalent flow characteristics may be approved on a case-by-case basis by the Responsible Official

- A flow length-to-width ratio greater than the 3:1 minimum is desirable. If the ratio is 4:1 or greater, then the dividing berm is not required, and the pond may consist of one cell rather than two. A one-cell pond must provide at least 6-inches of sediment storage depth. A one cell pond must also provide a minimum depth of 4 feet for the volume equivalent to the first cell of a two-cell design.

- Sediment storage shall be provided in the first cell. The sediment storage shall have a minimum depth of 1 foot. A fixed sediment depth monitor must be installed in the first cell to gauge sediment accumulation unless an alternative gauging method is proposed.
- The minimum depth of the first cell shall be 4 feet, exclusive of sediment storage requirements. The depth of the first cell may be greater than the depth of the second cell.
- The maximum depth of each cell shall not exceed 8 feet (exclusive of sediment storage in the first cell). Pool depths of 3 feet or shallower (second cell) shall be planted with emergent wetland vegetation (see Planting requirements).
- Inlets and outlets shall be placed to maximize the flow path through the facility. The ratio of flow path length to width from the inlet to the outlet shall be at least 3:1. The flow path length is defined as the distance from the inlet to the outlet, as measured at mid-depth. The width at mid-depth can be found as follows:  $\text{width} = (\text{average top width} + \text{average bottom width})/2$ .
- Wetponds with wetpool volumes less than or equal to 4,000 cubic feet may be single-celled (i.e., no baffle or berm is required). However, it is especially important in this case that the flow path length be maximized. The ratio of flow path length to width shall be at least 4:1 in single celled wetponds.
- All inlets shall enter the first cell. If there are multiple inlets, the length-to-width ratio shall be based on the average flow path length for all inlets.
- The first cell must be lined in accordance with the liner requirements contained in [Section 3.1.6, Facility Liners](#).

### **Berms, Baffles, and Slopes**

- A berm or baffle shall extend across the full width of the wetpool, and tie into the wetpond side slopes. If the berm embankments are greater than 4 feet in height, the berm must be constructed by excavating a key equal to 50 percent of the embankment cross-sectional height and width. This requirement may be waived if recommended by a geotechnical engineer for specific site conditions. The geotechnical analysis shall address situations in which one of the two cells is empty while the other remains full of water.
- The top of the berm may extend to the WQ design water surface or be 1-foot below the WQ design water surface. If at the WQ design water surface, berm side slopes should be 3H:1V. Berm side slopes may be steeper (up to 2:1) if the berm is submerged 1-foot.

Intent: Submerging the berm is intended to enhance safety by discouraging pedestrian access when side slopes are steeper than 3H:1V. An alternative to the submerged berm design is the use of barrier planting to prevent easy access to the divider berm in an unfenced wetpond.

- If good vegetation cover is not established on the berm, erosion control measures must be used to prevent erosion of the berm back-slope when the pond is initially filled.

- The interior berm or baffle may be a retaining wall provided that the design is prepared and stamped by a licensed civil engineer. If a baffle or retaining wall is used, it should be submerged one foot below the design water surface to discourage access by pedestrians.
- Criteria for wetpond side slopes are included in [Section 3.1.4](#).
- See [BMP D6.10](#), Detention ponds, for information on fencing.

### Embankments

Embankments that impound water must comply with the Washington State Dam Safety Regulations ([Chapter 173-175 WAC](#)). If the impoundment has a storage capacity (including both water and sediment storage volumes) greater than 10 acre-feet (435,600 cubic feet or 3.26 million gallons) above natural ground level, then dam safety design and review are required by Ecology.

### Inlet and Outlet

See [Figure 4.26](#) and [Figure 4.27](#) for details on the following requirements:

- The inlet to the wetpond shall be submerged with the inlet pipe invert a minimum of two feet from the pond bottom (not including sediment storage). The top of the inlet pipe should be submerged at least 1-foot, if possible.

Intent: The inlet is submerged to dissipate energy of the incoming flow. The distance from the bottom is set to minimize resuspension of settled sediments. Alternative inlet designs that accomplish these objectives are acceptable.

- An outlet structure shall be provided. Either a Type 2 catch basin with a grated opening (jail house window) or a manhole with a cone grate (birdcage) may be used (see [Figure 6.8](#) for an illustration). No sump is required in the outlet structure for wetponds not providing detention storage. The outlet structure receives flow from the pond outlet pipe. The grate or birdcage openings provide an overflow route should the pond outlet pipe become clogged. The overflow criteria provided below specifies the sizing and position of the grate opening.
- The pond outlet pipe (as opposed to the manhole or type 2 catch basin outlet pipe) shall be back-sloped or have a turn-down elbow, and extend 1 foot below the WQ design water surface. Note: A floating outlet, set to draw water from 1 foot below the water surface, is also acceptable if vandalism concerns are adequately addressed.

Intent: The inverted outlet pipe provides for trapping of oils and floatables in the wetpond.

- The pond outlet pipe shall be sized, at a minimum, to pass the on-line WQ design flow. Note: The highest invert of the outlet pipe sets the WQ design water surface elevation.
- The overflow criteria for single-purpose (treatment only, not combined with flow control) wetponds are as follows:
  - The requirement for primary overflow is satisfied by either the grated inlet to the outlet structure or by a birdcage above the pond outlet structure.

- The bottom of the grate opening in the outlet structure shall be set at or above the height needed to pass the WQ design flow through the pond outlet pipe. Note: The grate invert elevation sets the overflow water surface elevation.
- The grated opening should be sized to pass the 100-year design flow. The capacity of the outlet system should be sized to pass the peak flow for the conveyance requirements.
- An emergency spillway shall be provided and designed according to the requirements for detention ponds (see [BMP D6.10](#), in [Section 6.2](#)).
- The Responsible Official may require a bypass/shutoff valve to enable the pond to be taken offline for maintenance purposes.
- A gravity drain for maintenance is recommended if grade allows.

Intent: It is anticipated that sediment removal will only be needed for the first cell in the majority of cases. The gravity drain is intended to allow water from the first cell to be drained to the second cell when the first cell is pumped dry for cleaning.

- The drain invert shall be at least 6 inches below the top elevation of the dividing berm or baffle. Deeper drains are encouraged where feasible, but must be no deeper than 18 inches above the pond bottom.

Intent: To prevent highly sediment-laden water from escaping the pond when drained for maintenance.

- The drain shall be at least 8 inches (minimum) diameter and shall be controlled by a valve. Use of a shear gate is allowed only at the inlet end of a pipe located within an approved structure.

Intent: Shear gates often leak if water pressure pushes on the side of the gate opposite the seal. The gate should be situated so that water pressure pushes toward the seal.

- Operational access to the valve shall be provided to the finished ground surface.
- The valve location shall be accessible and well-marked with 1-foot of paving placed around the box. It must also be protected from damage and unauthorized operation.
- A valve box is allowed to a maximum depth of 5 feet without an access manhole. If over 5 feet deep, an access manhole or vault is required.
- All metal parts shall be corrosion-resistant. Galvanized materials should not be used unless unavoidable.

Intent: Galvanized metal contributes zinc to stormwater, sometimes in very high concentrations.

## Planting Requirements

Planting requirements for detention ponds also apply to wetponds.

- Large wetponds intended for phosphorus control should not be planted within the cells, as the plants will release phosphorus in the winter when they die off.
- If the second cell of a basic wetpond is 3 feet or less, the bottom area shall be planted with emergent wetland vegetation. See [Table 4.11](#) for recommended emergent wetland plant species for wetponds.

Intent: Planting of shallow pond areas helps to stabilize settled sediment and prevent resuspension.

- Cattails (*Typha latifolia*) are not recommended because they tend to crowd out other native species.
- If the wetpond discharges to a phosphorus-sensitive lake or wetland, shrubs that form a dense cover should be planted on slopes above the WQ design water surface on at least three sides. Some suitable trees and shrubs include vine maple (*Acer circinatum*), red osier dogwood (*Cornus stolonifera*), California myrtle (*Myrica californica*), and Pacific yew (*Taxus brevifolia*).

Intent: Plantings discourage waterfowl use of the pond that could increase fecal matter as well as provide shading.

Note: for banks that are berms, no planting is allowed if the berm is regulated by dam safety requirements.

### Recommended Design Features

The following design features should be incorporated into the wetpond design where site conditions allow:

- The method of construction of soil/landscape systems can cause natural selection of specific plant species. Consult a soil restoration or wetland soil scientist for site-specific recommendations. The soil formulation will impact the plant species that will flourish or suffer on the site, and the formulation should be such that it encourages desired species and discourages undesired species.
- For wetpool depths in excess of 6 feet, some form of recirculation is recommended in the summer, such as a fountain or aerator, to prevent stagnation and low dissolved oxygen conditions.
- A flow length-to-width ratio greater than the 3:1 minimum is desirable. If the ratio is 4:1 or greater, then the dividing berm is not required, and the pond may consist of one cell rather than two. A one cell pond must provide at least 6-inches of sediment storage depth. A one cell pond must also provide a minimum depth of 4 feet for the volume equivalent to the first cell of a two-cell design.
- A tear-drop shape, with the inlet at the narrow end, rather than a rectangular pond is preferred since it minimizes dead zones caused by corners.

- A small amount of base flow is desirable to maintain circulation and reduce the potential for low oxygen conditions during late summer.
- Evergreen or columnar deciduous trees along the west and south sides of ponds are recommended to reduce thermal heating, except that no trees or shrubs may be planted on berms meeting the criteria of dams regulated for safety. Trees should be set back so that the branches will not extend over the pond.

Intent: Evergreen trees or shrubs are preferred to avoid problems associated with leaf drop. Columnar deciduous trees (e.g., Douglas hawthorn / *Crataegus douglasii*, Cascara / *Frangula purshiana*, Pacific crabapple / *Malus fusca*, etc.) typically have fewer leaves than other deciduous trees.

- The number of inlets to the facility should be limited; ideally there should be only one inlet. The flow path length should be maximized from inlet to outlet for all inlets to the facility.
- The access and maintenance road could be extended along the full length of the wetpond and could double as a nature trail or picnic areas. Part of the access road should extend near the water's edge to allow visual access to the pond year-round (for safety purposes). Plantings should be a minimum of 8 feet from the edge of the access road to limit plant overgrowth onto the access route and maintain good visibility for access and use. Placing finely ground bark or other natural material over the road surface would render it more pedestrian-friendly.
- The following design features should be incorporated to enhance aesthetics where possible:
  - Provide pedestrian access to shallow pool areas enhanced with emergent wetland vegetation. This allows the pond to be more accessible without incurring safety risks.
  - Provide side slopes that are sufficiently gentle to avoid the need for fencing (3:1 or flatter). If this is not possible and the facility needs to be fenced, see the fencing section in [BMP D6.10, Detention Ponds](#).
  - Create flat areas overlooking or adjoining the pond for picnic tables or seating that can be used by residents. Walking or jogging trails around the pond are easily integrated into site design.
  - Provide visual enhancement with clusters of trees and shrubs. On most pond sites, it is important to amend the soil before planting since ponds are typically placed well below the native soil horizon in very poor soils. Make sure dam safety restrictions against planting do not apply.
  - Orient the pond length along the direction of prevailing summer winds (typically west or southwest) to enhance wind mixing.

## Construction Criteria

- Sediment that has accumulated in the pond must be removed after construction in the drainage area of the pond is complete (unless used for a liner - see below).

- Sediment that has accumulated in the pond at the end of construction may be used in excessively drained soils to meet the liner requirements if the sediment meets the criteria for low permeability or treatment liners in keeping with guidance in [section 3.1.6](#). The sediment must not reduce the design volume of the pond. The pond must be over-excavated initially to provide sufficient room for the sediments to serve as a liner.

**Table 4.11: Emergent Wetland Plant Species Acceptable for Wetponds**

<b>Inundation to 1 Foot</b>		Table Continues Following Page	
<u>Botanical Name</u>	<u>Common Name</u>	<u>Notes</u>	<u>Max. Depth</u>
<i>Agrostis exarata</i> <sup>(1)</sup>	Spike bent grass	Prairie to coast	to 2 feet
<i>Carex stipata</i>	Sawbeak sedge	Wet ground	
<i>Eleocharis palustris</i>	Spike rush	Margins of ponds, wet meadows	to 2 feet
<i>Glyceria occidentalis</i>	Western mannagrass	Marshes, pond margins	to 2 feet
<i>Juncus tenuis</i>	Slender rush	Wet soils, wetland margins	
<i>Oenanthe sarmentosa</i>	Water parsley	Shallow water along stream and pond margins; needs saturated soils all summer	
<i>Scirpus atrocinctus</i> (formerly <i>S. cyperinus</i> )	Woolgrass	Tolerates shallow water; tall clumps	
<i>Scirpus microcarpus</i>	Small-fruited bulrush	Wet ground to 18 inches depth	18 inches
<i>Sagittaria latifolia</i>	Arrowhead		
<b>Inundation 1 to 2 feet</b>			
<u>Botanical Name</u>	<u>Common Name</u>	<u>Notes</u>	<u>Max. Depth</u>
<i>Agrostis exarata</i> <sup>(1)</sup>	Spike bent grass	Prairie to coast	
<i>Eleocharis palustris</i>	Spike rush	Margins of ponds, wet meadows	
<i>Glyceria occidentalis</i>	Western mannagrass	Marshes, pond margins	
<i>Juncus effusus</i>	Soft rush	Wet meadows, pastures, wetland margins	
<i>Scirpus microcarpus</i>	Small-fruited bulrush	Wet ground to 18 inches depth	18 inches
<i>Sparganium emmersum</i>	Bur reed	Shallow standing water, saturated soils	
<b>Inundation 1 to 3 feet</b>			

<u>Botanical Name</u>	<u>Common Name</u>	<u>Notes</u>	<u>Max. Depth</u>
<i>Carex obnupta</i>	Slough sedge	Wet ground or standing water	1.5 to 3 feet
<i>Beckmania syzigachne</i> <sup>(1)</sup>	Western sloughgrass	Wet prairie to pond margins	
<i>Scirpus acutus</i> <sup>(2)</sup>	Hardstem bulrush	Single tall stems, not clumping	to 3 feet
<i>Scirpus validus</i> <sup>(2)</sup>	Softstem bulrush		5 feet

### **Inundation Greater Than 3 feet**

<u>Botanical Name</u>	<u>Common Name</u>	<u>Notes</u>	<u>Max. Depth</u>
<i>Nuphar polysepalum</i>	Spatterdock	Deep water	3 to 7.5 feet

### **Acceptable Seed Mix for Wet Ponds / Wet Pools**

<u>Species</u>	<u>Common Name</u>	<u>% by Weight</u>
<i>Scirpus acutus</i>	Hardstem bulrush	9%
<i>Juncus effusus</i>	Soft rush	9%
<i>Carex stipata</i>	Awl sedge	29.5%
<i>Glyceria occidentalis</i>	Western mannagrass	25%
<i>Eleocharis palustris</i>	Creeping spike rush	15%
<i>Eleocharis ovata</i>	Ovoid spike rush	9%
<i>Carex abnupta</i>	Slough sedge	3.5%

Selected plants shall not include any plants from the State of Washington Noxious Weed List. Refer to [www.clark.wa.gov/environmental-services/vegetation-management](http://www.clark.wa.gov/environmental-services/vegetation-management) for a current list of noxious weeds.

<sup>(1)</sup> Non-native species. Native species are preferred.

<sup>(2)</sup> *Scirpus* tubers must be planted shallower for establishment, and protected from foraging waterfowl until established. Emerging aerial stems should project above water surface to allow oxygen transport to the roots.

*Primary sources:* Municipality of Metropolitan Seattle, *Water Pollution Control Aspects of Aquatic Plants*, 1990. Hortus Northwest, *Wetland Plants for Western Oregon*, Issue 2, 1991. Hitchcock and Cronquist, *Flora of the Pacific Northwest*, 1973.



## BMP T10.20: Wetvault

---

### Purpose and Description

A wetvault is an underground structure similar in appearance to a detention vault, except that a wetvault has a permanent pool of water (wetpool), which dissipates energy and improves the settling of particulate pollutants. Being underground, the wetvault lacks the biological pollutant removal mechanisms such as algae uptake, present in surface wetponds.

If oil control is required for a project, a wetvault may be combined with an API oil/water separator.

### Cross Reference Guide

Soils Assessment	None
Minimum Requirements/ Treatment Type	MR #6, Basic, or either Enhanced or Phosphorus when included in a two-facility treatment train.
Related BMPs	<a href="#">BMPs T8.10</a> , <a href="#">T8.20</a> , or <a href="#">T8.40</a> (with media approved for basic or enhanced treatment) for a treatment train.
Selection/Infeasibility Criteria	<a href="#">Book 1, Section 3.2 and Section 3.4.5</a>
Maintenance	<a href="#">Book 4</a>

### Applications, Limitations and Setbacks

A wetvault may be used for commercial, industrial, or roadway projects if there are space limitations precluding the use of other treatment BMPs. The use of wetvaults for residential development is highly discouraged. Combined detention and wetvaults are allowed; see [BMP D6.40](#).

A wetvault is believed to be ineffective in removing dissolved pollutants such as soluble phosphorus or metals such as copper. There is also concern that oxygen levels will decline, especially in warm summer months, because of limited contact with air and wind. However, the extent to which this potential problem occurs has not been documented.

Below-ground structures like wetvaults are relatively difficult and expensive to maintain. The need for maintenance is often not seen and as a result routine maintenance does not occur.

If oil control is required for a project, a wetvault may be combined with an API oil/water separator.

## Setbacks

See [Section 3.1.4](#).

## Design Criteria

### Sizing Procedure

As with wetponds, the primary design factor that determines the removal efficiency of a wetvault is the volume of the wetpool. The larger the volume, the higher the potential for pollutant removal. Performance is also improved by avoiding dead zones, such as corners, where little exchange occurs, by using large length-to-width ratios, dissipating energy at the inlet, and ensuring that flow rates are uniform to the extent possible within and between cells.

The sizing procedure for a wetvault is identical to the sizing procedure for a wetpond. The wetpool volume for the wetvault shall be equal to or greater than the total volume of runoff from the 6-month, 24-hour storm event. Alternatively, use the Water Quality Design Storm Volume estimated by an approved continuous flow model.

Typical design details and concepts for the wetvault are shown in [Figure 4.28](#).

### Wetpool Geometry

Same as specified for wetponds (see [BMP T10.10](#)) except for the following two modifications:

- The sediment storage in the first cell shall be an average of 1 foot. Because of the v-shaped bottom, the depth of sediment storage needed above the bottom of the side wall is roughly proportional to vault width according to the schedule below:

<u>Vault Width</u>	<u>Sediment Depth (from bottom of side wall)</u>
15'	10"
20'	9"
40'	6"
60'	4"

- The second cell shall be a minimum of 3 feet deep.

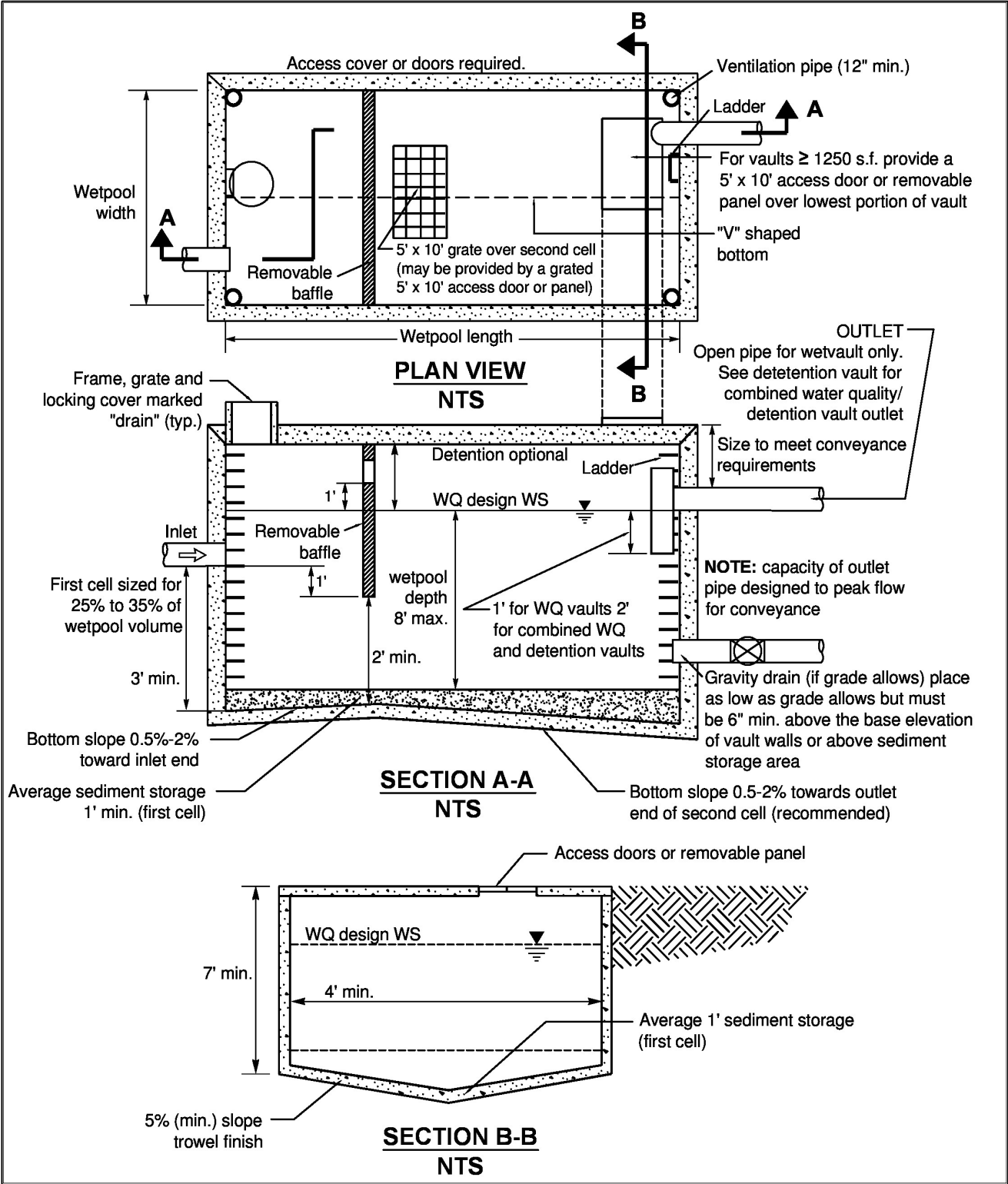


Figure 4.28: Wetvault

(Note: Hinged locking doors are to be provided for all access locations to this vault)

## Vault Structure

- The vault shall be separated into two cells by a wall or a removable baffle. If a wall is used, a 5-foot by 10-foot removable maintenance access must be provided for both cells. If a removable baffle is used, the following criteria apply:
  1. The baffle shall extend from a minimum of 1 foot above the WQ design water surface to a minimum of 1 foot below the invert elevation of the inlet pipe.
  2. The lowest point of the baffle shall be a minimum of 2 feet from the bottom of the vault, and greater if feasible.
- If the vault is less than 2,000 cubic feet (inside dimensions), or if the length-to-width ratio of the vault pool is 5:1 or greater, the baffle or wall may be omitted and the vault may be one-celled.
- The two cells of a wetvault should not be divided into additional subcells by internal walls. If internal structural support is needed, it is preferred that post and pier construction be used to support the vault lid rather than walls. Any walls used within cells must be positioned so as to lengthen, rather than divide, the flow path.

Intent: Treatment effectiveness in wetpool facilities is related to the extent to which plug flow is achieved and short-circuiting and dead zones are avoided. Structural walls placed within the cells can interfere with plug flow and create significant dead zones, reducing treatment effectiveness.

- The bottom of the first cell shall be sloped toward the access opening. Slope should be between 0.5 percent (minimum) and 2 percent (maximum). The second cell floor may be level (longitudinally) sloped toward the outlet, with a high point between the first and second cells. The intent of sloping the bottom is to direct the sediment accumulation to the closest access point for maintenance purposes. Sloping the second cell toward the access opening for the first cell is also acceptable.
- The vault bottom shall slope laterally a minimum of 5 percent from each side towards the center, forming a broad "v" to facilitate sediment removal. Note: More than one "v" may be used to minimize vault depth.

Exception: The Responsible Official may allow the vault bottom to be flat if removable panels are provided over the entire vault. Removable panels should be at grade, have stainless steel lifting eyes, and weigh no more than 5 tons per panel.

- The highest point of a vault bottom must be at least 6 inches below the outlet elevation to provide for sediment storage over the entire bottom.
- Provision for passage of flows should the outlet plug shall be provided.
- Wetvaults may be constructed using arch culvert sections provided the top area at the WQ design water surface is, at a minimum, equal to that of a vault with vertical walls designed with an average depth of 6 feet.

Intent: To prevent decreasing the surface area available for oxygen exchange.

- Wetvaults shall conform to the "Materials" and "Structural Stability" design criteria specified for detention vaults ([BMP D6.30](#), in [Section 6.2](#)).
- Where pipes enter and leave the vault below the WQ design water surface, they shall be sealed using a non-porous, non-shrinking grout.

### Inlet and Outlet

- The inlet to the wetvault shall be submerged with the inlet pipe invert a minimum of 3 feet from the vault bottom. The top of the inlet pipe should be submerged at least 1-foot, if possible.

Intent: The submerged inlet is to dissipate energy of the incoming flow. The distance from the bottom is to minimize resuspension of settled sediments. Alternative inlet designs that accomplish these objectives are acceptable.

- Unless designed as an off-line facility, the capacity of the outlet pipe and available head above the outlet pipe should be designed to convey the 100-year design flow for developed site conditions without overtopping the vault. The available head above the outlet pipe must be a minimum of 6 inches.
- The outlet pipe shall be back-sloped or have tee section, the lower arm of which should extend 1 foot below the WQ design water surface to provide for trapping of oils and floatables in the vault.
- The Responsible Official may require a bypass/shutoff valve to enable the vault to be taken offline for maintenance.

### Access Requirements

Access requirements are the same as for detention vaults (see [BMP D6.30](#), in [Section 6.2](#)) except for the following additional requirements:

- A minimum of 50 square feet of grate should be provided over the second cell. For vaults in which the surface area of the second cell is greater than 1,250 square feet, 4 percent of the top should be grated. This requirement may be met by one grate or by many smaller grates distributed over the second cell area. Note: a grated access door can be used to meet this requirement.

Intent: The grate allows air contact with the wetpool in order to minimize stagnant conditions which can result in oxygen depletion, especially in warm weather.

- All underground vault systems require access via a vault door, not manhole, for worker safety and access and usability.

## Recommended Design Features

The following design features should be incorporated into wetvaults where feasible, but they are not specifically required:

- The floor of the second cell should slope toward the outlet for ease of cleaning.
- The inlet and outlet should be at opposing corners of the vault to increase the flow path.
- A flow length-to-width ratio greater than 3:1 is desirable.
- Lockable grates instead of solid manhole covers are recommended to increase air contact with the wetpool.
- Galvanized materials shall not be used unless unavoidable.
- The number of inlets to the wetvault should be limited, and the flow path length should be maximized from inlet to outlet for all inlets to the vault.

## Construction Criteria

Sediment that has accumulated in the vault must be removed after construction in the drainage area is complete. If no more than 12 inches of sediment have accumulated after the infrastructure is built, cleaning may be left until after building construction is complete. In general, sediment accumulation from stabilized drainage areas is not expected to exceed an average of 4 inches per year in the first cell. If sediment accumulation is greater than this amount, it will be assumed to be from construction unless it can be shown otherwise.

## Modifications for Combining with an API (Baffle) Oil/Water Separator

If the project site is a high-use site and a wetvault is proposed, the vault may be combined with a baffle oil/water separator ([BMP T11.10](#)) to meet the runoff treatment requirements with one facility rather than two. Structural modifications and additional design criteria are given below. Maintenance requirements for baffle oil/water separators and for wetvault must both be followed. This will result in more frequent inspection and cleaning than for a wetvault used only for TSS removal.

1. The sizing procedures for the baffle oil/water separator should be run as a check to ensure the vault is large enough. If the oil/water separator sizing procedures result in a larger vault size, increase the wetvault size to match.
2. An oil retaining baffle shall be provided in the second cell near the vault outlet. The baffle should not contain a high-flow overflow, or else the retained oil will be washed out of the vault during large storms.
3. The vault shall have a minimum length-to-width ratio of 5:1.
4. The vault shall have a design water depth-to-width ratio of between 1:3 and 1:2.

5. The vault shall be watertight and shall be coated to protect from corrosion.
6. Separator vaults shall have a shutoff mechanism on the outlet pipe to prevent oil discharges during maintenance and to provide emergency shut-off capability in case of a spill. A valve box and riser shall also be provided.
7. Wetvaults used as oil/water separators must be off-line and must bypass flows greater than the off-line WQ design flow multiplied by the off-line ratio indicated in [Figure 4.3](#).

Intent: This design minimizes the entrainment and/or emulsification of previously captured oil during very high flow events.

## BMP T10.30: Stormwater Treatment Wetlands

---

### Purpose and Description

Stormwater treatment wetlands are shallow man-made ponds that are designed to treat stormwater through the biological processes associated with emergent aquatic plants.

Wetlands created to mitigate disturbance impacts, such as filling, may not also be used as stormwater treatment facilities because the two types of wetlands have incompatible functions. Mitigation wetlands are intended to function as full replacement habitat for fish and wildlife, providing the same functions and harboring the same species diversity and biotic richness as the wetlands they replace. Stormwater treatment wetlands are used to capture and transform pollutants and over time pollutants will concentrate in the sediment.

Use of existing wetlands for stormwater treatment is addressed in Minimum Requirement #8 in [Book 1, section 1.5.8](#).

In general, stormwater wetlands perform well to remove sediment, metals, and pollutants that bind to humic or organic acids. Phosphorus removal in stormwater wetlands is highly variable.

Another consideration is that vegetation must occasionally be harvested and sediment removed from stormwater treatment wetlands. This can result in considerable expense and disrupt wetland wildlife habitat.

### Cross Reference Guide

Soils Assessment	None necessary
Minimum Requirements/ Treatment Type	MR #6, Basic or Enhanced
Related BMPs	None
Selection/Infeasibility Criteria	<a href="#">Book 1, Section 3.2 and Section 3.4.5</a>
Maintenance	<a href="#">Book 4</a>

### Applications, Limitations and Setbacks

This stormwater wetland design occupies about the same surface area as wetponds, but has the potential to be better integrated aesthetically into a site because of the abundance of emergent aquatic vegetation. The most critical factor for a successful design is the provision of an adequate supply of water for most of the year. Careful planning is needed to be sure sufficient water will be



retained to sustain good wetland plant growth. Since water depths are shallower than in wetponds, water loss by evaporation is an important concern. Stormwater wetlands are a good WQ facility choice in areas with high winter groundwater levels.

## Setbacks

See [Section 3.1.4](#).

## Design Criteria

Stormwater wetlands employ some of the same design features as wetponds. However, the dominant treatment process is pollutant removal mediated by aquatic vegetation and the microbiological community associated with it instead of gravity settling. Thus, when designing wetlands, factors that affect plant vigor and biomass are the primary concerns.

## Sizing Procedure

- **Step 1:** The volume of a basic wetpond is used as a template for sizing the stormwater wetland. The design volume is the total volume of runoff from the 6-month, 24-hour storm event. Alternatively, use the Water Quality Design Storm Volume estimated by an approved continuous flow model.
- **Step 2:** Calculate the surface area of the stormwater wetland. The surface area of the wetland shall be the same as the top area of a wetpond sized for the same site conditions. Calculate the surface area of the stormwater wetland by using the volume from Step 1 and dividing by the average water depth (use 3 feet).
- **Step 3:** Determine the surface area of the first cell (the presettling basin) of the stormwater wetland. Use the volume determined from Criterion 2 under "Wetland Geometry" (below), and the actual depth of the presettling basin.
- **Step 4:** Determine the surface area of the wetland cell. Subtract the surface area of the presettling basin (Step 3) from the total surface area (Step 2).
- **Step 5:** Determine water depth distribution in the second cell. Decide if the top of the dividing berm will be at the surface or submerged (designer's choice). Adjust the distribution of water depths in the second cell according to Criterion 8 under "Wetland Geometry" (below).

Note: This will result in a facility that holds less volume than that determined in Step 1 above. This is acceptable.

Intent: The surface area of the stormwater wetland is set to be roughly equivalent to that of a wetpond designed for the same site so as not to discourage use of this option.

- **Step 6:** Choose plants. See [Table 4.11](#) for a list of plants recommended for wetpond water depth zones, or consult a wetland scientist.

## Wetland Geometry

1. Stormwater wetlands shall consist of two cells, a presettling basin or forebay and a wetland cell.
2. The presettling cell shall contain approximately 33 percent of the wetpool volume calculated in Step 1 above.
3. The depth of the presettling cell shall be between 4 feet (minimum) and 8 feet (maximum), excluding sediment storage.
4. One foot of sediment storage shall be provided in the presettling cell.
5. The wetland cell shall have an average water depth of about 1.5 feet (plus or minus 3 inches).
6. The berm separating the two cells shall be shaped such that its downstream side gradually slopes to form the second shallow wetland cell. Alternatively, the second cell may be graded naturalistically from the top of the dividing berm (see Criterion 8 below).
7. The top of berm shall be either at the WQ design water surface or submerged 1 foot below the WQ design water surface, as with wetponds. Correspondingly, the side slopes of the berm must meet the following criteria:
  - n. If the top of berm is at the WQ design water surface, the berm side slopes shall be no steeper than 3H:1V.
  - o. If the top of berm is submerged 1 foot, the upstream side slope may be up to 2H:1V. If the berm is at the water surface, then for safety reasons, its slope should be not greater than 3:1, just as the pond banks should not be greater than 3:1 if the pond is not fenced. A steeper slope (2:1 rather than 3:1) is allowable if the berm is submerged in 1 foot of water. If submerged, the berm is not considered accessible, and the steeper slope is allowable.
8. Two examples are provided for grading the bottom of the wetland cell. One example is a shallow, evenly graded slope from the upstream to the downstream edge of the wetland cell (see [Figure 4.29](#)). The second example is a "naturalistic" alternative, with the specified range of depths intermixed throughout the second cell (see [Figure 4.30](#)). A distribution of depths shall be provided in the wetland cell depending on whether the dividing berm is at the water surface or submerged (see [Table 4.12](#)). The maximum depth is 2.5 feet in either configuration. Other configurations within the wetland geometry constraints listed above may be approved by the Responsible Official.
9. The access and maintenance road could be extended along the full length of the stormwater wetland and could double as a nature trail or picnic areas. Part of the access road should extend near the water's edge to allow visual access to the pond year-round (for safety purposes).
10. Criteria for wetpond side slopes are included in [Section 3.1.4](#).

11. See [BMP D6.10](#), Detention Ponds, for information on fencing.
12. Plantings should be a minimum of 8 feet from the edge of the access road to limit plant overgrowth onto the access route and maintain good visibility for access and use. Placing finely ground bark or other natural material over the road surface would render it more pedestrian-friendly.

**Table 4.12: Distribution of Depths in Wetland Cell**

Dividing Berm at WQ Design Water Surface		Dividing Berm Submerged 1-Foot	
Depth Range (feet)	Percent	Depth Range (feet)	Percent
0.1 to 1	25	1 to 1.5	40
1 to 2	55	1.5 to 2	40
2 to 2.5	20	2 to 2.5	20

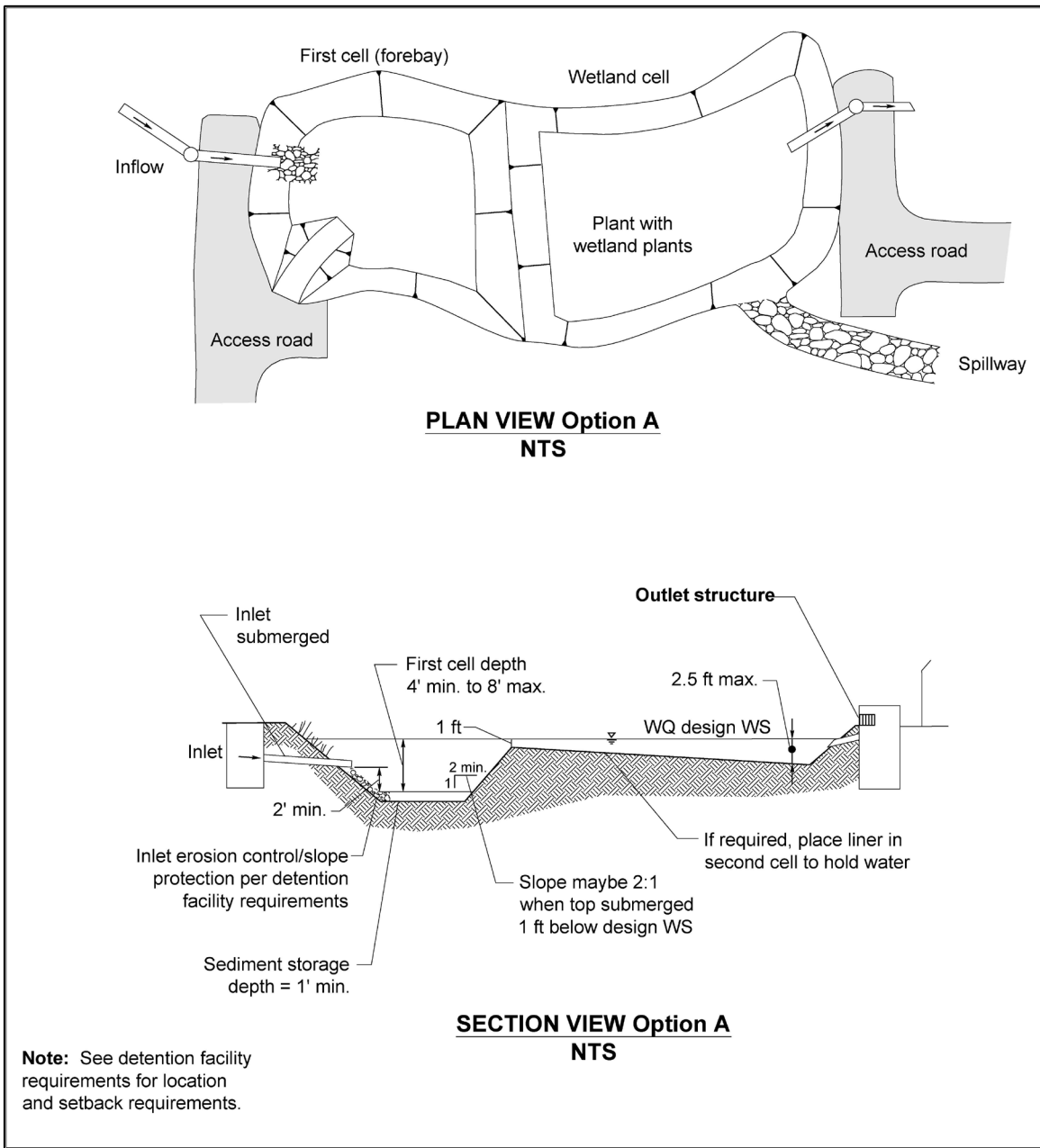
### Lining Requirements

Constructed wetlands are not intended to infiltrate. In infiltrative soils, both cells of the stormwater wetland shall be lined. To determine whether a low-permeability liner or a treatment liner is required, determine whether the following conditions will be met. If soil permeability will allow sufficient water retention, lining may be waived.

1. The second cell must retain water for at least 10 months of the year.
2. The presettling basin must retain at least three feet of water year-round.
3. A complete precipitation record shall be used when establishing these conditions. Evapotranspiration losses shall be taken into account as well as infiltration losses.

Intent: Many wetland plants can adapt to periods of summer drought, so a limited drought period is allowed in the second cell. This may allow a treatment liner rather than a low permeability liner to be used for the second cell. The presettling basin must retain water year-round in order for the presettling function to be effective.

- If a low permeability liner is used, a minimum of 18 inches of native soil amended with good topsoil or compost (one part compost mixed with 3 parts native soil) must be placed over the liner. For geomembrane liners, a soil depth of 3 feet is recommended to prevent damage to the liner during planting. Hydric soils are not required.
- The design criteria for liners given in [section 3.1.6](#) must be followed.
- For information on fencing, see [BMP D6.10](#) Detention Ponds in [Section 6.2](#).



**Figure 4.29: Stormwater Wetland - Option 1**

(Source: Department of Ecology)

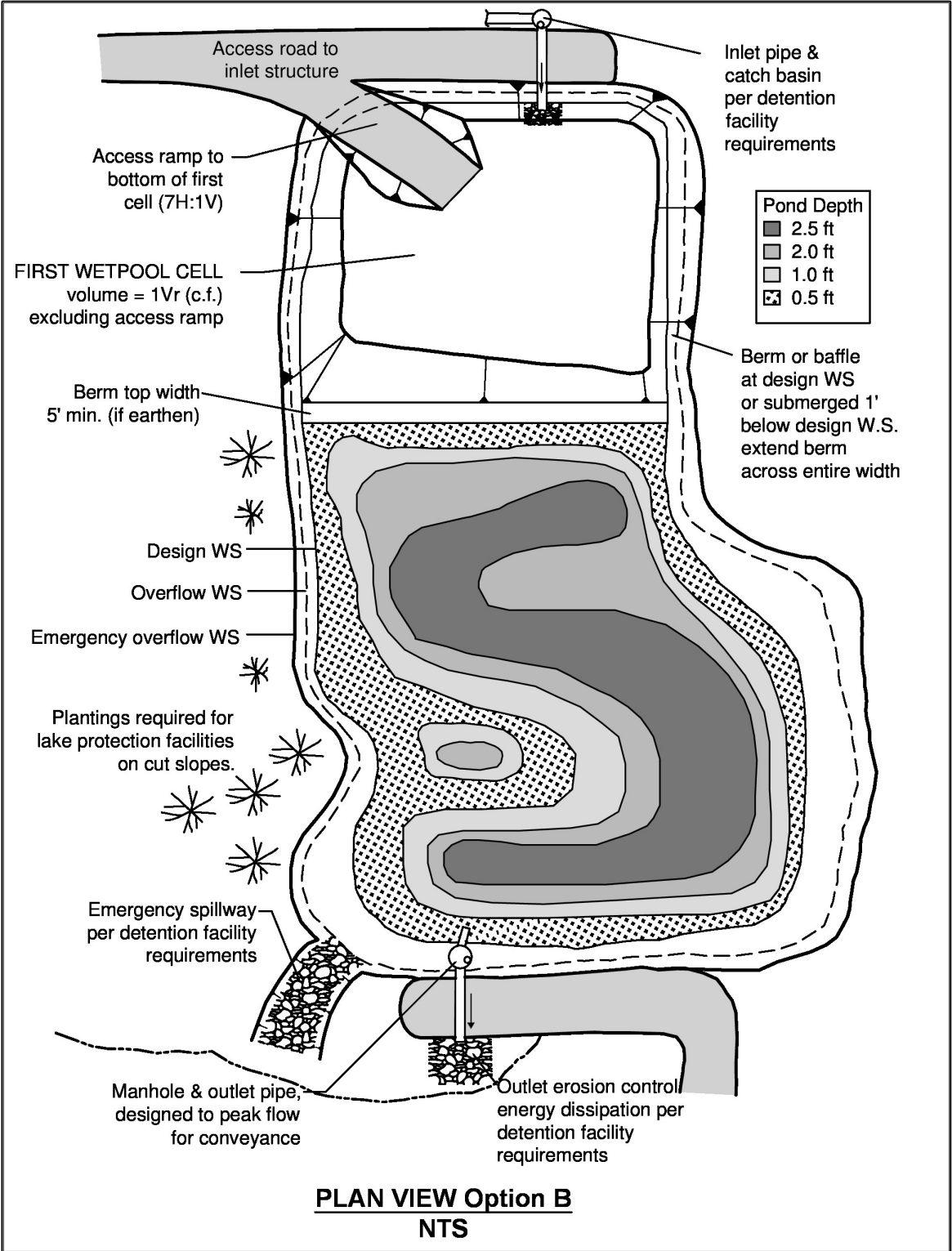


Figure 4.30: Stormwater Wetland - Option 2

(Source: Department of Ecology)

## Inlet and Outlet

Same as for wetponds (see [BMP T10.10](#)).

## Access

- Location of the stormwater wetland relative to site constraints (e.g., buildings, property lines) shall be the same as for detention ponds. See [Section 3.1.4](#) for typical setback requirements for water quality facilities.
- Access and maintenance roads shall be provided and designed according to the requirements for detention ponds (see Volume III). Access and maintenance roads shall extend to both the wetland inlet and outlet structures. An access ramp (7H minimum:1V) shall be provided to the bottom of the first cell unless all portions of the cell can be reached and sediment loaded from the top of the wetland side slopes.
- If the dividing berm is also used for access, it should be built to sustain loads of up to 80,000 pounds.

## Planting Requirements

The wetland cell shall be planted with emergent wetland plants such as the acceptable plants in [Table 4.13](#) or following the recommendations of a wetland specialist. Note: Cattails (*Typha latifolia*) are not recommended. They tend to escape to natural wetlands and crowd out other species and often colonize treatment wetlands anyway. In addition, the shoots die back each fall and may result in oxygen depletion in the wetpool.

Table 4.13: Acceptable Plants for Treatment Wetlands

<b>Inundation to 1 Foot</b>			
<u>Botanical Name</u>	<u>Common Name</u>	<u>Notes</u>	<u>Max. Depth</u>
<i>Agrostis exarata</i> <sup>(1)</sup>	Spike bent grass	Prairie to coast	to 2 feet
<i>Carex stipata</i>	Sawbeak sedge	Wet ground	
<i>Eleocharis palustris</i>	Spike rush	Margins of ponds, wet meadows	to 2 feet
<i>Glyceria occidentalis</i>	Western mannagrass	Marshes, pond margins	to 2 feet
<i>Juncus tenuis</i>	Slender rush	Wet soils, wetland margins	
<i>Oenanthe sarmentosa</i>	Water parsley	Shallow water along stream and pond margins; needs saturated soils all summer	
<i>Scirpus atrocinctus</i> (formerly <i>S. cyperinus</i> )	Woolgrass	Tolerates shallow water; tall clumps	
<i>Scirpus microcarpus</i>	Small-fruited bulrush	Wet ground to 18 inches depth	18 inches
<i>Sagittaria latifolia</i>	Arrowhead		
<b>Inundation 1 to 2 feet</b>			
<u>Botanical Name</u>	<u>Common Name</u>	<u>Notes</u>	<u>Max. Depth</u>
<i>Agrostis exarata</i> <sup>(1)</sup>	Spike bent grass	Prairie to coast	
<i>Eleocharis palustris</i>	Spike rush	Margins of ponds, wet meadows	
<i>Glyceria occidentalis</i>	Western mannagrass	Marshes, pond margins	
<i>Juncus effusus</i>	Soft rush	Wet meadows, pastures, wetland margins	
<i>Scirpus microcarpus</i>	Small-fruited bulrush	Wet ground to 18 inches depth	18 inches
<i>Sparganium emmersum</i>	Bur reed	Shallow standing water, saturated soils	
<b>Inundation 1 to 3 feet</b>			
<u>Botanical Name</u>	<u>Common Name</u>	<u>Notes</u>	<u>Max. Depth</u>
<i>Carex obnupta</i>	Slough sedge	Wet ground or standing water	1.5 to 3 feet
<i>Beckmania syzigachne</i> (1)	Western sloughgrass	Wet prairie to pond margins	
<i>Scirpus acutus</i> (2)	Hardstem bulrush	Single tall stems, not clumping	to 3 feet

<i>Scirpus validus</i> (2)	Softstem bulrush		
<b>Inundation Greater Than 3 feet</b>			
<u>Botanical Name</u>	<u>Common Name</u>	<u>Notes</u>	<u>Max. Depth</u>
<i>Nuphar polysepalum</i>	Spatterdock	Deep water	3 to 7.5 feet
<b>Acceptable Seed Mix for Wet Ponds / Wet Pools</b>			
<u>Species</u>	<u>Common Name</u>	<u>% by Weight</u>	
<i>Scirpus acutus</i>	Hardstem bulrush	9%	
<i>Juncus effusus</i>	Soft rush	9%	
<i>Carex stipata</i>	Awl sedge	29.5%	
<i>Glyceria occidentalis</i>	Western mannagrass	25%	
<i>Eleocharis palustris</i>	Creeping spike rush	15%	
<i>Eleocharis ovata</i>	Ovoid spike rush	9%	
<i>Carex abnupta</i>	Slough sedge	3.5%	
<p>Selected plants shall not include any plants from the State of Washington Noxious Weed List. Refer to <a href="http://www.clark.wa.gov/environmental-services/vegetation-management">www.clark.wa.gov/environmental-services/vegetation-management</a> for a current list of noxious weeds.</p> <p>(1) Non-native species. Native species are preferred.</p> <p>(2) <i>Scirpus</i> tubers must be planted shallower for establishment, and protected from foraging waterfowl until established. Emerging aerial stems should project above water surface to allow oxygen transport to the roots.</p> <p>Primary sources: Municipality of Metropolitan Seattle, Water Pollution Control Aspects of Aquatic Plants, 1990. Hortus Northwest, Wetland Plants for Western Oregon, Issue 2, 1991. Hitchcock and Cronquist, Flora of the Pacific Northwest, 1973.</p>			

## Habitat Structures

Based on recommendations of wetland specialist, identify the appropriate types of habit structures for anticipated wildlife use. Potential structures could include vertical snags, brush piles, root wads, log piles, bat boxes, wood duck/owl boxes, etc. Determine appropriate horizontal spacing to effectively support habitat at the appropriate water depths for anticipated wildlife species.

## Construction Criteria

- Construction and maintenance considerations are the same as for wetponds.
- Construction of the naturalistic alternative (Option 2) can be easily accomplished by first excavating the entire area to the 1.5-foot average depth. Then soil subsequently excavated to form deeper areas can be deposited to raise other areas until the distribution of depths indicated in the design is achieved.



## Resource Material

King County Surface Water Design Manual, September 1998.

Schueler, Thomas. *Design of Stormwater Wetland Systems, Guidelines for Creating Diverse and Effective Stormwater Wetland Systems in the Mid-Atlantic Region*, October, 1992.

Kadlec, Robert and Robert L. Knight. *Treatment Wetlands*. 1996.

Karen Capiella, Lisa Fraley-McNeal, Mike Novotney, and Tom Schueler, Center for Watershed Protection, *The Next Generation of Stormwater Wetlands*, February 2008.

### **Proprietary BMP: StormFilter®**

---

- For proprietary products, refer to the Ecology General Use Level Designation standards and current manufacturer's specifications for product materials and installation instructions.
- Hinged locking covers are to be provided for all access locations to this vault.

### **Proprietary BMP: Filterra®**

---

- For proprietary products, refer to the Ecology General Use Level Designation standards and current manufacturer's specifications for product materials and installation instructions.

### **Proprietary BMP: Perk Filter™**

---

- For proprietary products, refer to the Ecology General Use Level Designation standards and current manufacturer's specifications for product materials and installation instructions.
- Hinged locking covers are to be provided for all access locations to this vault.

# Chapter 5 Flow Control: Infiltration

## Chapter Contents

<b>5.1</b>	<b>Infiltration Facility Design</b> .....	<b>249</b>
5.1.1	Infiltration Facility Design Criteria.....	249
5.1.1.1	Setbacks.....	250
5.1.1.2	Groundwater Mounding Analysis.....	250
5.1.1.3	Pretreatment Facility Design Criteria.....	251
5.1.1.4	Construction Criteria.....	251
5.1.2	Infiltration Facility Testing.....	252
<b>5.2</b>	<b>Infiltration BMPs</b> .....	<b>253</b>
BMP R5.10	Infiltration Drywells.....	253
BMP R5.11	Infiltration Trenches.....	256
BMP R5.12	Infiltration Basins.....	259

## Chapter Figures

Figure 5.1:	Schematic of Infiltration Trench - Not to Scale.....	256
Figure 5.2:	Observation Well Details.....	258

## Chapter Tables

Table 5.1:	Stormwater Infiltration Facility Setbacks.....	250
------------	--	-----

This page intentionally left blank.

## 5.1 Infiltration Facility Design

This section presents the methods and criteria for the design of infiltration facilities. These facilities provide for the temporary storage of and infiltration of surface water runoff resulting from development pursuant to the performance standards set forth in Minimum Requirement #7 for flow control. These facilities can also be used to meet the Low Impact Development Performance Standard. See [Section 1.5.5.2 in Book 1](#).

An approved continuous flow model must be used to determine compliance with Minimum Requirement #7. When using WWHM for simulating flow through an infiltrating facility, represent the facility by using a Pond Element and entering the design infiltration rates.

Below are the procedures for (A) sizing a pond to completely infiltrate 100% of runoff; and (B) to partially infiltrate runoff to meet the flow duration standard.

### (A) For 100% infiltration

1. Input dimensions of the infiltration pond.
2. Input infiltration rate and safety (rate reduction) factor.
3. Input a riser height and diameter (any flow through the riser indicates less than 100% infiltration, and the infiltration pond dimensions must be increased).
4. Run only HSPF for the Developed Mitigated Scenario. A duration analysis is not needed for this exercise.
5. Go back to the infiltration pond and review the Percentage Infiltrated at the bottom right. If less than 100% infiltrated, increase facility size until 100% is infiltrated.

### (B) To meet the flow duration standard with infiltration basins

This design will allow something less than 100% infiltration as long as any overflows meet the flow duration standard. Use a discharge structure with orifices and risers similar to a detention facility and include infiltration occurring from the pond.

#### 5.1.1 Infiltration Facility Design Criteria

- The slope of the base of the infiltration facility should be less than 3 percent.
- Spillways/overflow structures – Construct a nonerodible outlet or spillway with a firmly established elevation to discharge overflows. Calculate ponding depth, drawdown time, and storage volume from that reference point.

- The base of all infiltration basins or trench systems shall be greater than or equal to five feet above the seasonal high-water mark, bedrock (or hardpan) or other low permeability layer. A separation down to three feet may be considered if the groundwater mounding analysis, volumetric receptor capacity, and the design of the overflow and/or bypass structures are judged by the site professional to be adequate to prevent overtopping.
- Reference [BMP D6.10](#), in [Section 6.2](#) for Overflow and Emergency Overflow design criteria.

### 5.1.1.1 Setbacks

Reference BMP D6.10 and BMP 6.20 for landscape requirements at stormwater facilities.

Infiltration facility setbacks shall be per [Table 5.1](#).

**Table 5.1: Stormwater Infiltration Facility Setbacks**

<b>Stormwater infiltration facility setback from:</b>	<b>Distance</b>
Drinking water wells	100 feet minimum
Building foundations	20 feet minimum from the downslope side of foundations 100 feet minimum from the upslope side of foundations These setbacks may be increased or decreased based on engineering analysis that shows the performance of the building's foundation system will not be adversely affected by the presence of the stormwater facility
Slopes equal to or greater than 15%	50 feet minimum from the crests of slopes. This setback may be increased or decreased based on engineering analysis that shows the stability of the slope will not be adversely affected by the presence of the stormwater facility.
Property lines	20 feet from any property line. However, if an infiltration trench is a common system shared by the two or more adjacent lots and contained within an easement for maintenance given to owners of all lots draining to the system, then the setback from the property line(s) shared by the adjacent lots may be waived.

### 5.1.1.2 Groundwater Mounding Analysis

Groundwater mounding occurs under infiltration areas where the infiltration of stormwater causes the water under the infiltration facility to “mound up” before dispersing into the ground. This can occur where groundwater or a low permeability soil layer is near the surface. Groundwater mounding can reduce infiltration rates and cause the failure of infiltration facilities.

A groundwater mounding analysis shall be conducted at all sites where the following occurs:

- The depth to either the seasonal groundwater table or a low permeability soil stratum is less than five feet from the infiltration facility bottom; or
- The depth to the seasonal groundwater table or low permeability stratum is less than 15 feet, and the effective impervious area contributing runoff to the infiltration facility is greater than one acre.

Groundwater modeling (mounding analysis) of the proposed infiltration facility shall be done using the design infiltration rate and the estimated maximum groundwater elevation determined for the proposed facility location.

The design infiltration rate determined above can be used as input to an approved continuous flow model to do an initial sizing. Then complete the groundwater modeling (mounding analysis) of the proposed infiltration facility. Use MODRET or an equivalent model.

Export the full output hydrograph of the developed condition and use it as model input. Note that an iterative process may be required beginning with an estimated design rate, WWHM (or MGSFlood) sizing, then groundwater model testing.

### 5.1.1.3 Pretreatment Facility Design Criteria

Pretreatment of is required for each  
~~A facility to treat~~ stormwater influent for suspended solids ~~must precede the~~ infiltration facility. Use either an option under the basic treatment facility menu or the pretreatment menu (See [Book 1, Chapter 3](#) for menus). Pretreatment is important in preserving the life of the facility. The lower the influent suspended solids loading to the infiltration facility, the longer the infiltration facility can infiltrate the designed amount of stormwater.

### 5.1.1.4 Construction Criteria

This information must be included on the construction drawings for all infiltration facilities.

- Conduct initial basin excavation to within 1-foot of the final elevation of the basin floor. For open infiltration systems, rough excavating using heavy equipment shall only be allowed down to 3 feet above the proposed bottom elevation. The remainder of excavation shall be done from the sides or above. Excavate infiltration trenches and basins to final grade only after all disturbed areas in the up gradient project drainage area have been permanently stabilized. The final phase of excavation should remove all accumulation of silt in the infiltration facility before putting it in service.
- Do not use infiltration facilities as temporary sediment traps during construction.
- Traffic Control – Relatively light-tracked equipment is required for this operation to avoid compaction of the basin floor. Consider the use of draglines and trackhoes for constructing infiltration basins. Flag or mark the infiltration area to keep heavy equipment away.

- No permanent infiltration systems shall be allowed into service until the entire contributing drainage area has received final stabilization (to avoid clogging of the facility by eroded soil), and permanent county-approved water quality BMPs are in place. Final grading of the infiltration facility shall occur only after the contributing drainage areas are fully stabilized. Final grading should be performed using equipment positioned along the sides of the facility and not on the bottom of the facility. The infiltration facility must be flagged or cordoned off to prevent equipment from compacting soil in infiltration area.

## 5.1.2 Infiltration Facility Testing

During construction of the infiltration facility, a qualified professional who performed the infiltration testing, or an alternate qualified professional, shall observe the excavation and confirm that the soils are consistent with those tests on which the design was based. This observation shall take place prior to the placement of any filter fabric or drain rock specified on the plans and be included in a stamped letter from the qualified professional.

The constructed facility must be tested to demonstrate that the facility performs as designed. Use the same test method for coefficient of permeability as used in the design stages so that results are comparable. Perform the testing after the sites have been excavated and the infiltration soils have been exposed. Submit the results and comparisons to the pre-project measured and design rates to Clark County in a written memorandum signed and stamped by an appropriate professional licensed in the state of Washington.

If the tested coefficient of permeability determined at the time of construction is at least 95 percent of the uncorrected coefficient of permeability used to determine the design rate, construction may proceed. If the tested rate does not meet this requirement, the Applicant shall submit a plan to Clark County that follows the requirements in [Book 1, Section 1.8.5](#). This plan shall address steps to correct the problem, including additional testing and/or resizing of the facility to ensure that the system will meet the minimum requirements of this manual.



## 5.2 Infiltration BMPs

### BMP R5.10 Infiltration Drywells

---

#### Description

A drywell is an underground structure used for infiltrating stormwater runoff by dissipating it into the ground. The drywell discharges the runoff through small diameter holes in the sides of and bottom of the well. A drywell may be either a structural chamber and/or an excavated pit filled with aggregate. Drywells are typically installed similar to manholes with the exception that rounded aggregate is placed beneath around the drywell.

#### Cross Reference Guide

Soils Assessment	<a href="#">Book 1, Section 4.3.1</a>
Minimum Requirements	#7, #5 LID Performance Standard
Related BMPs	See <a href="#">Book 1, Chapter 3</a> to select a runoff treatment BMP meeting MR #6
Selection/Infeasibility Criteria	<a href="#">Book 1, Section 4.3.1</a>
Maintenance	<a href="#">Book 4</a>

#### Applications, Limitations, and Setbacks

Infiltration facilities for complying with the LID performance standard and the flow control requirement are used to convey stormwater runoff from new development or redevelopment to the ground and groundwater after appropriate treatment. Infiltration facilities for treatment purposes rely on the soil profile to provide treatment. In either case, manage runoff in excess of the infiltration capacity of the facilities to comply with the flow control requirement in [Book 1](#), if flow control applies to the project.

Infiltration facilities can help accomplish the following:

- Groundwater recharge.
- Discharge of uncontaminated or properly treated stormwater to drywells in compliance with Ecology’s UIC regulations ([Chapter 173-218 WAC](#)).
- Retrofits in limited land areas: Infiltration trenches can be considered for residential lots, commercial areas, parking lots, and open space areas.
- Flood control.

- Streambank erosion control.

## Setbacks

See [Section 5.1.1.1](#).

## Design Criteria

- The basic design parameters for a drywell are its storage volume and the permeability rate of the subgrade soils. A drywell must have sufficient storage volume to contain the design runoff volume without overflow (using an approved continuous flow model), while the subgrade soils' permeability rate must be sufficient to drain the stored runoff within 72 hours. Note that infiltration facilities for roofs that use the sizing criteria included with those BMPs ([T5.10A](#) and [T5.10B](#)) do not need to use a continuous flow model for those designs.
- A drywell must be designed to infiltrate the total runoff volume generated by the drywell's maximum design storm.
- The bottom of the drywell including aggregate backfill material must be at least 5 feet above seasonal high water table or bedrock and be as level as possible to uniformly distribute runoff infiltration over the subgrade soils.
- Backfill Material - The aggregate material for the infiltration trench should meet WSDOT Specification 9-03.12(5) that ranges from ¾" to 1-½" diameter. A maximum diameter of 3 inches and a minimum diameter of 1.5 inches may be approved if void space is maintained. Void space for these aggregates should be in the range of 30 to 40 percent.

## Construction Criteria

- Construction of a drywell must be done without compacting the drywell's subgrade soils. As such, all excavation must be performed by equipment placed outside the drywell whenever possible. This requirement should be considered when designing the dimensions and total storage volume of a drywell.
- Stone Aggregate Placement and Compaction - Place stone aggregate in lifts and compact using plate compactors. In general, a maximum loose lift thickness of 12 inches is recommended. The compaction process ensures geotextile conformity to the excavation sides, thereby reducing potential piping and geotextile clogging, and settlement problems.
- Potential Contamination - Prevent natural or fill soils from intermixing with the stone aggregate. Remove all contaminated stone aggregate and replaced with uncontaminated stone aggregate.
- Overlapping and Covering - Following the stone aggregate placement, fold the geotextile over the stone aggregate to form a 12 inch minimum longitudinal overlap. When overlaps are required between rolls, the upstream roll should overlap a minimum of 2 feet over the downstream roll in order to provide a shingled effect.
- Voids behind Geotextile - Voids between the geotextile and excavation sides must be avoided.

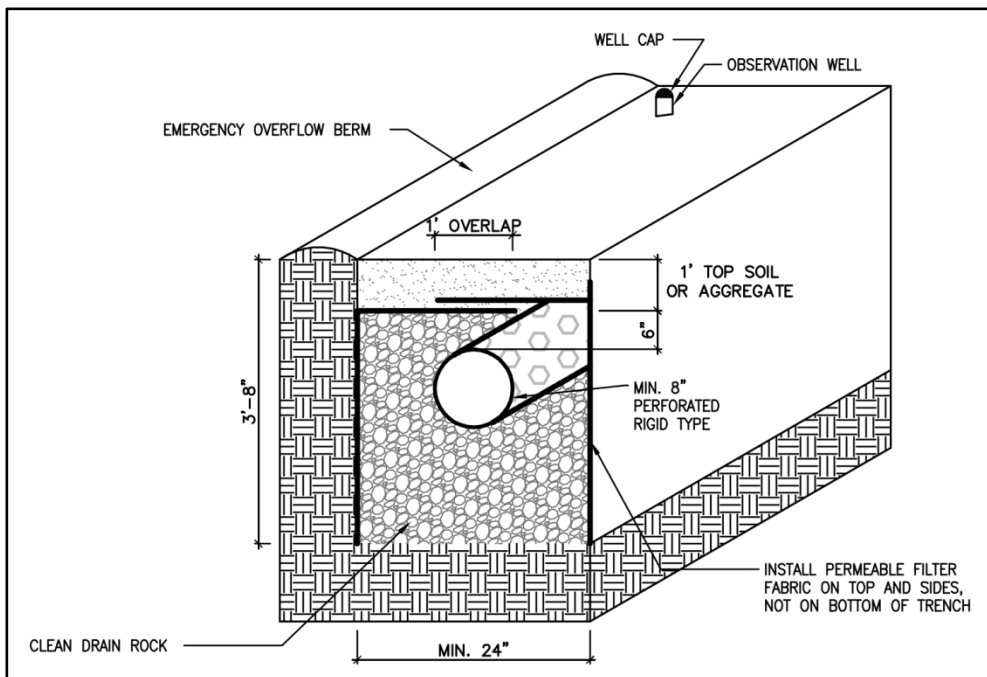
Removing boulders or other obstacles from the trench walls is one source of such voids. Place natural soils in these voids at the most convenient time during construction to ensure geotextile conformity to the excavation sides. This remedial process will avoid soil piping, geotextile clogging, and possible surface subsidence.

- Unstable Excavation Sites - Vertically excavated walls may be difficult to maintain in areas where the soil moisture is high or where soft or cohesionless soils predominate. Trapezoidal, rather than rectangular, cross-sections may be needed.

## BMP R5.11 Infiltration Trenches

### Purpose and Description

Infiltration trenches are generally at least 24 inches wide, and are backfilled with a coarse aggregate, allowing for temporary storage of stormwater runoff in the voids of the aggregate material. Stored runoff then gradually infiltrates into the surrounding soil. The surface of the trench can be covered with grating and/or consist of clean gravel, gabion, sand, or a grassed covered area with a surface inlet. Perforated rigid pipe of at least 8-inch diameter can also be used to distribute the stormwater in a gravel trench.



**Figure 5.1: Schematic of Infiltration Trench - Not to Scale**

(Source: redrawn from WA Dept. of Ecology)

### Cross Reference Guide

See Infiltration Drywells.

### Applications, Limitations, and Setbacks

See Infiltration Drywells.

### Design Criteria

- Due to accessibility and maintenance limitations, carefully design and construct infiltration trenches.

- Consider including an access port or open or grated top for accessibility to conduct inspections and maintenance.
- Backfill Material - The aggregate material for the infiltration trench should meet WSDOT Specification 9-03.12(5) that ranges from ¾” to 1-½” diameter. A maximum diameter of 3 inches and a minimum diameter of 1.5 inches may be approved if void space is maintained. Void space for these aggregates should be in the range of 30 to 40 percent.
- Geotextile fabric liner – Completely encase the sides and top of the aggregate fill material in an engineering geotextile material. Geotextile should surround all of the aggregate fill material except for the top one-foot, which is placed over the geotextile. Carefully select geotextile fabric with acceptable properties to avoid plugging (see [Appendix 2-G](#)).
- The bottom sand or geotextile fabric as shown is optional. Note that geotextile fabric on the bottom of the trench is not allowed.

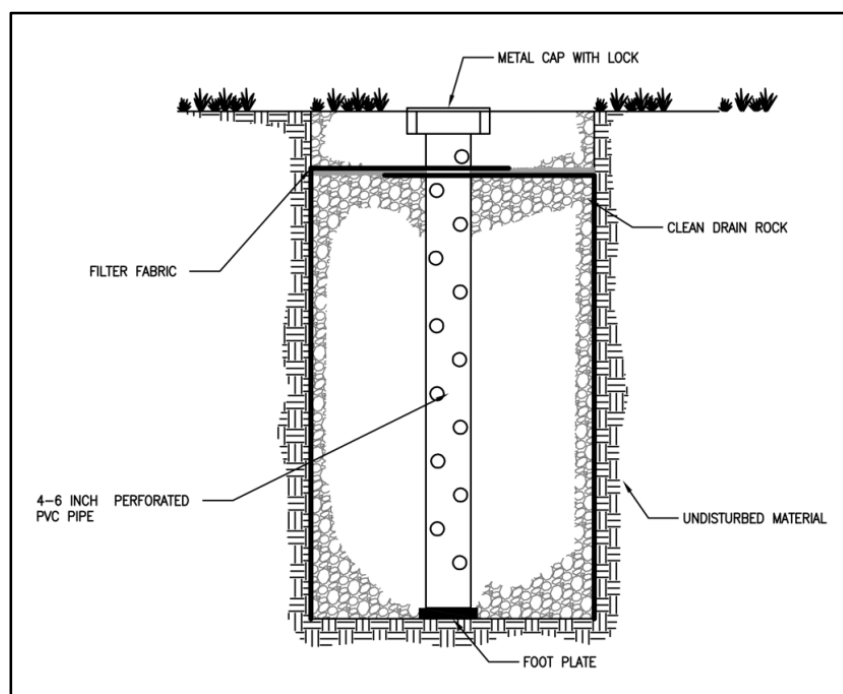
Refer to the Federal Highway Administration Manual Geosynthetic Design and Construction Guidelines, Publication No. FHWA HI-95-038, May 1995 for design guidance on geotextiles in drainage applications. Refer to the NCHRP Report 367, Long-Term Performance of Geosynthetics in Drainage Applications, 1994, for long-term performance data and background on the potential for geotextiles to clog, blind, or to allow piping to occur and how to design for these issues.

- Overflow Channel - Because an infiltration trench is generally used for small drainage areas, an emergency spillway is not necessary. However, provide a non-erosive overflow channel leading to a stabilized watercourse.
- Surface Cover - A stone filled trench can be placed under a porous or impervious surface cover to conserve space.
- Observation Well - Install an observation well at the lower end of the infiltration trench to check water levels, drawdown time, sediment accumulation, and conduct water quality monitoring. [Figure 5.2](#) illustrates observation well details. It should consist of a perforated PVC pipe which is 4 to 6 inches in diameter and it should be constructed flush with the ground elevation. For larger trenches a 12-36 inch diameter well can be installed to facilitate maintenance operations such as pumping out the sediment. Cap the top of the well to discourage vandalism and tampering.

### Construction Criteria

- Trench Preparation - Place excavated materials away from the trench sides to enhance trench wall stability. Take care to keep this material away from slopes, neighboring property, sidewalks and streets. It is recommended that this material be covered with plastic. ([BMP C123](#) – Plastic Covering, in [Chapter 8](#)).
- Stone Aggregate Placement and Compaction - Place stone aggregate in lifts and compact using plate compactors. In general, a maximum loose lift thickness of 12 inches is recommended. The compaction process ensures geotextile conformity to the excavation sides, thereby reducing potential piping and geotextile clogging, and settlement problems.

- Potential Contamination - Prevent natural or fill soils from intermixing with the stone aggregate. Remove all contaminated stone aggregate and replaced with uncontaminated stone aggregate.
- Overlapping and Covering - Following the stone aggregate placement, fold the geotextile over the stone aggregate to form a 12 inch minimum longitudinal overlap. When overlaps are required between rolls, the upstream roll should overlap a minimum of 2 feet over the downstream roll in order to provide a shingled effect.
- Voids behind Geotextile - Voids between the geotextile and excavation sides must be avoided. Removing boulders or other obstacles from the trench walls is one source of such voids. Place natural soils in these voids at the most convenient time during construction to ensure geotextile conformity to the excavation sides. This remedial process will avoid soil piping, geotextile clogging, and possible surface subsidence.
- Unstable Excavation Sites - Vertically excavated walls may be difficult to maintain in areas where the soil moisture is high or where soft or cohesionless soils predominate. Trapezoidal, rather than rectangular, cross-sections may be needed.



**Figure 5.2: Observation Well Details**

(Source: redrawn from WA Department of Ecology)

## BMP R5.12 Infiltration Basins

---

### Purpose and Description

Infiltration basins are earthen impoundments used for the collection, temporary storage and infiltration of incoming stormwater runoff.

### Cross-Reference Guide

See Infiltration Drywells.

### Applications, Limitations, and Setbacks

See Infiltration Drywells.

### Design Criteria

- Provide access for vehicles to easily maintain the forebay (presettling basin) area without disturbing vegetation or re-suspending sediment any more than absolutely necessary.
- See [BMP D6.10](#), Detention ponds, for information on fencing.
- The slope of the basin bottom should not exceed 3% in any direction.
- Size the basin for a maximum ponding depth of between 2 and 6 feet.
- A minimum of one foot of freeboard is recommended when establishing the design ponded water depth. Freeboard is measured from the rim of the infiltration facility to the maximum ponding level or from the rim down to the overflow point if an overflow or a spillway is included.
- Provide erosion protection of inflow points to the basin (e.g., riprap, flow spreaders, energy dissipaters). Select suitable vegetative materials to stabilize the basin floor and side slopes. Refer to recommended vegetation for detention ponds ([BMP D6.10](#) in [Section 6.2](#)).
- Lining material – Basins can be open or covered with a 6 to 12-inch layer of filter material such as coarse sand, or a suitable filter fabric to help prevent the buildup of impervious deposits on the soil surface. Select a nonwoven geotextile that will function sufficiently without plugging (see geotextile specifications in [Appendix 2-G](#)). Replace or clean the filter layer when/if it becomes clogged.
- Vegetation – Stabilize the embankment, emergency spillways, spoil and borrow areas, and other disturbed areas and plant, preferably with a low-grow mix, in accordance with recommended vegetation for detention ponds ([BMP D6.10](#) in [Section 6.2](#)). Without healthy vegetation, the surface soil pores will quickly plug.
- For information on fencing, see [BMP D6.10](#) Detention Ponds in [Section 6.2](#).

This page intentionally left blank.



# Chapter 6 Flow Control: Detention

## Chapter Contents

<b>6.1</b>	<b>Detention Facility Design .....</b>	<b>263</b>
6.1.1	General Design Criteria.....	263
6.1.2	Methods of Analysis .....	264
6.1.3	Setbacks .....	264
6.1.4	Control Structure Design.....	264
<b>6.2</b>	<b>Detention BMPs .....</b>	<b>273</b>
	BMP D6.10 Detention Ponds.....	273
	BMP D6.20 Detention Tanks .....	285
	BMP D6.30 Detention Vaults.....	289
	Additional Detention BMPs.....	293
	BMP D6.40: Combined Detention and Wetpool Facilities.....	294

## Chapter Figures

Figure 6.1:	Flow Restrictor (TEE) .....	266
Figure 6.2:	Flow Restrictor (Baffle).....	267
Figure 6.3:	Flow Restrictor (Weir).....	268
Figure 6.4:	Simple Orifice.....	269
Figure 6.5:	Rectangular, Sharp Crested Weir .....	270
Figure 6.6:	Riser Inflow Curves .....	272
Figure 6.7:	Typical Detention Pond Sections .....	275
Figure 6.8:	Overflow Structure .....	276
Figure 6.9:	Weir Section for Emergency Overflow Spillway.....	283
Figure 6.10:	Typical Detention Tank .....	287
Figure 6.11:	Detention Tank Access Detail.....	288
Figure 6.12:	Typical Detention Vault.....	292
Figure 6.13:	Combined Detention and Wetpond - Plan View.....	296
Figure 6.14:	Combined Detention and Wetpond - Section View.....	297
Figure 6.15:	Alternative Configurations of Detention and Wetpool Areas .....	298

## Chapter Tables

Table 6.1:	Detention Pond Side slopes.....	278
Table 6.2:	Low-Growing Turf Seed Mix .....	280

This page intentionally left blank

## 6.1 Detention Facility Design

This section presents the methods and criteria for the design of detention facilities, including ponds, vaults, and tanks. These facilities provide for the temporary storage of increased surface water runoff resulting from development pursuant to the performance standards set forth in Minimum Requirement #7 for flow control. Detention facilities can also be used to meet the LID Performance Standard. See [Section 1.5.5.2 in Book 1](#).

### 6.1.1 General Design Criteria

The following criteria apply to the design of all detention BMPs:

1. Stormwater detention facilities that can impound 10 acre-feet (435,600 cubic feet; 3.26 million gallons) or more with the water level measured at the embankment crest are subject to the state’s dam safety requirements, even if water storage is intermittent and infrequent (WAC 173-175-020(1)). This means sizing the emergency spillway to accommodate the runoff from the dam safety design storm. Other dam safety requirements include geotechnical issues, construction inspection and documentation, dam breach analysis, inundation mapping, emergency action planning, and periodic inspections by project owners and by Dam Safety engineers. Electronic versions of the guidance documents are available on the Department of Ecology Web site at <http://www.ecy.wa.gov/programs/wr/dams/dss.html>.
2. Facilities must be designed as flow-through systems. Stormwater must enter through a separate inflow conveyance system and discharge through the control structure and outflow conveyance system. Maximizing the distance between the inlet and outlet is encouraged to promote sedimentation. Note that parking lots and other areas used as auxiliary storage during large events do not need to be flow-through.
3. Provide a secondary inlet to the control structure as additional protection against overtopping should the inlet pipe to the control structure become plugged. A grated opening (“jailhouse window”) in the control structure manhole functions as a weir (see [Figure 6.7](#)) when used as a secondary inlet. Note: The maximum circumferential length of this opening must not exceed one-half the control structure circumference. The “birdcage” overflow structure as shown in [Figure 6.8](#) may also be used as a secondary inlet.
4. Provide a primary overflow (usually a riser pipe within the control structure) in all ponds, tanks, and vaults to bypass the 100-year developed peak flow over or around the restrictor system. The design for these overflows must assume the facility will be full due to plugged orifices or high inflows; the primary overflow is intended to protect against breaching of a pond embankment (or overflows of the upstream conveyance system in the case of a detention tank or vault). The design must provide controlled discharge directly into the downstream conveyance system or another acceptable discharge point.

5. Manhole and catch basin lids for control structures must be locking, and rim elevations must match proposed finish grade.
6. Manholes and catch-basins must meet the OSRA confined space requirements, which include clearly marking entrances to confined space areas. This may be accomplished by hanging a removable sign in the access riser, just under the access lid.
7. Design guidelines for flow control structures are specified in [Section 6.1.4](#).

## 6.1.2 Methods of Analysis

Design volumes and outflows for detention facilities shall be in accordance with Minimum Requirement #7 and the hydrologic analysis and design methods in [Chapter 1](#). The pre-developed condition to be matched shall be a forested land cover unless one of the following conditions is met:

- Reasonable, historic information is provided that indicates the site was prairie prior to settlement (see [Appendix 1-D](#)). These areas are modeled as “pasture” in the approved continuous flow model.
- The drainage area of the immediate stream and all subsequent downstream basins has had at least 40% total impervious area since 1985<sup>3</sup>. In this case, the pre-developed condition to be matched shall be the existing land cover condition. Where basin-specific studies determine a stream channel to be unstable, even though the above criterion is met, the pre-developed condition assumption shall be the “historic” land cover condition, or a land cover condition commensurate with achieving a target flow regime identified by an approved basin study.
- The development site TDA drains to a reach of a stream where an Ecology approved basin plan has been developed that includes an alternative pre-development standard. See [Appendix 1-B](#) for these areas.

## 6.1.3 Setbacks

- Detention facilities must be a minimum of 5 feet from any structure or property line..
- All facilities must be a minimum of 50 feet from the top of any steep (greater than 15%) slope, unless a geotechnical analysis is performed. A geotechnical analysis and report must be prepared addressing the potential impact of the facility on a slope steeper than 15%.

## 6.1.4 Control Structure Design

Control structures are catch basins or manholes with a restrictor device for controlling outflow from a facility to meet the desired performance. Riser type restrictor devices (“tees” or “FROP-Ts”) also provide some incidental oil/water separation to temporarily detain oil or other floatable pollutants in runoff due to accidental spill or illegal dumping.

---

<sup>3</sup> No areas in Clark County meet this criterion.

The restrictor device usually consists of two or more orifices and/or a weir section sized to meet performance requirements. Standard control structure details are shown in [Figure 6.1](#) through [Figure 6.3](#).

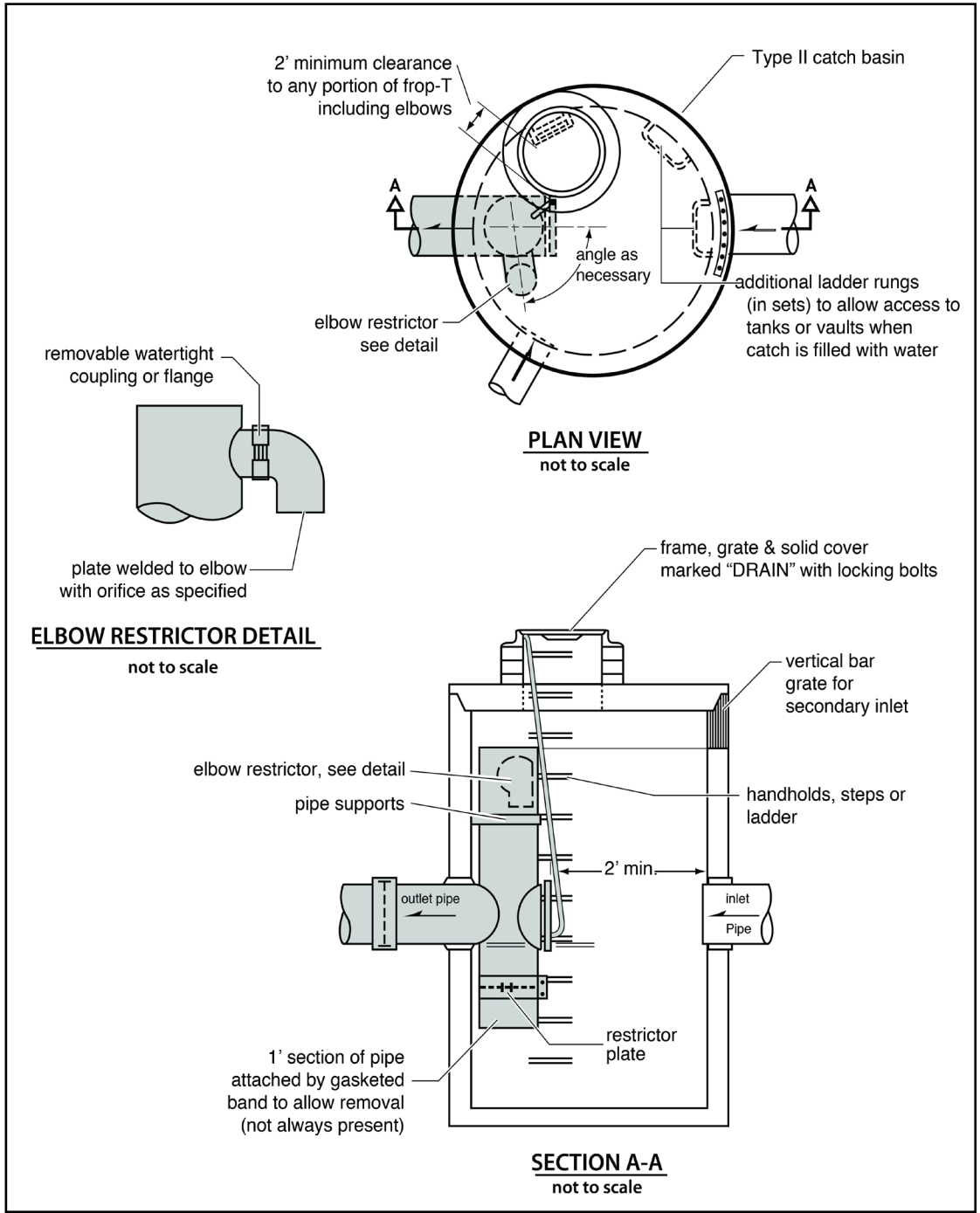
#### 6.1.4.1 Multiple Orifice Restrictor

In most cases, control structures need only two orifices: one at the bottom and one near the top of the riser, although additional orifices may best utilize detention storage volume. Several orifices may be located at the same elevation if necessary to meet performance requirements.

1. Minimum orifice diameter is 0.5 inches. Note: In some instances, a 0.5-inch bottom orifice will be too large to meet target release rates, even with minimal head. In these cases, the live storage depth need not be reduced to less than 3 feet in an attempt to meet the performance standards. Also, under such circumstances, flow-throttling devices may be a feasible option. These devices will throttle flows while maintaining a plug-resistant opening.
2. Orifices may be constructed on a tee section as shown in [Figure 6.1](#) or on a baffle as shown in [Figure 6.2](#).
3. In some cases, performance requirements may require the top orifice/elbow to be located too high on the riser to be physically constructed (e.g., a 13-inch diameter orifice positioned 0.5 feet from the top of the riser). In these cases, a notch weir in the riser pipe may be used to meet performance requirements (see [Figure 6.3](#)).
4. Consider the backwater effect of water surface elevations in the downstream conveyance system. High tailwater elevations may affect performance of the restrictor system and reduce live storage volumes.

#### 6.1.4.2 Riser and Weir Restrictor

1. Properly designed weirs may be used as flow restrictors. However, they must be designed to provide for primary overflow of the developed 100-year peak flow discharging to the detention facility.
2. The combined orifice and riser (or weir) overflow may be used to meet performance requirements; however, the design must still provide for primary overflow of the developed 100-year peak flow assuming all orifices are plugged. [Figure 6.6](#) can be used to calculate the head in feet above a riser of given diameter and flow.



**Figure 6.1: Flow Restrictor (TEE)**

(Source: King County)

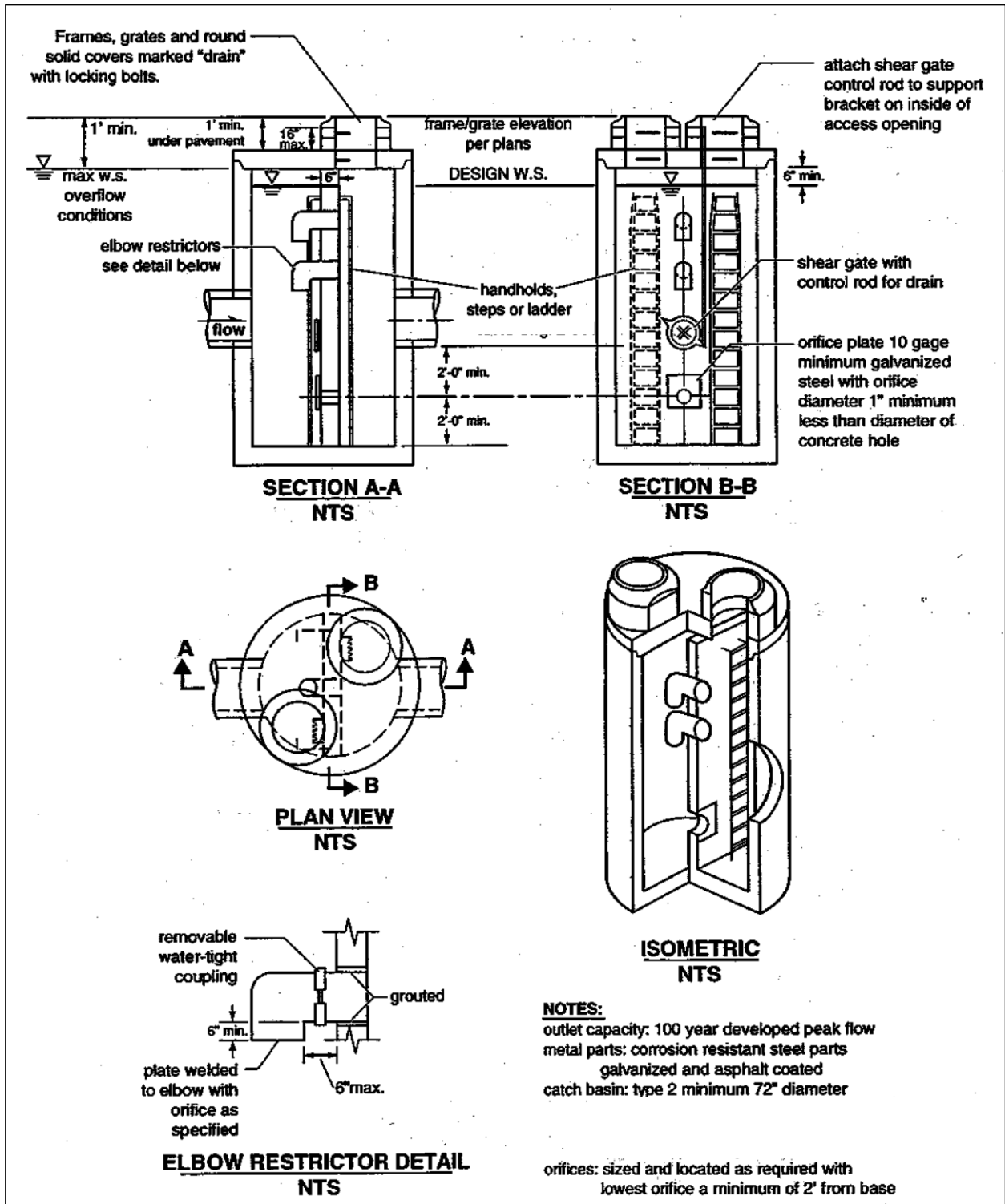


Figure 6.2: Flow Restrictor (Baffle)

(Source: Department of Ecology)

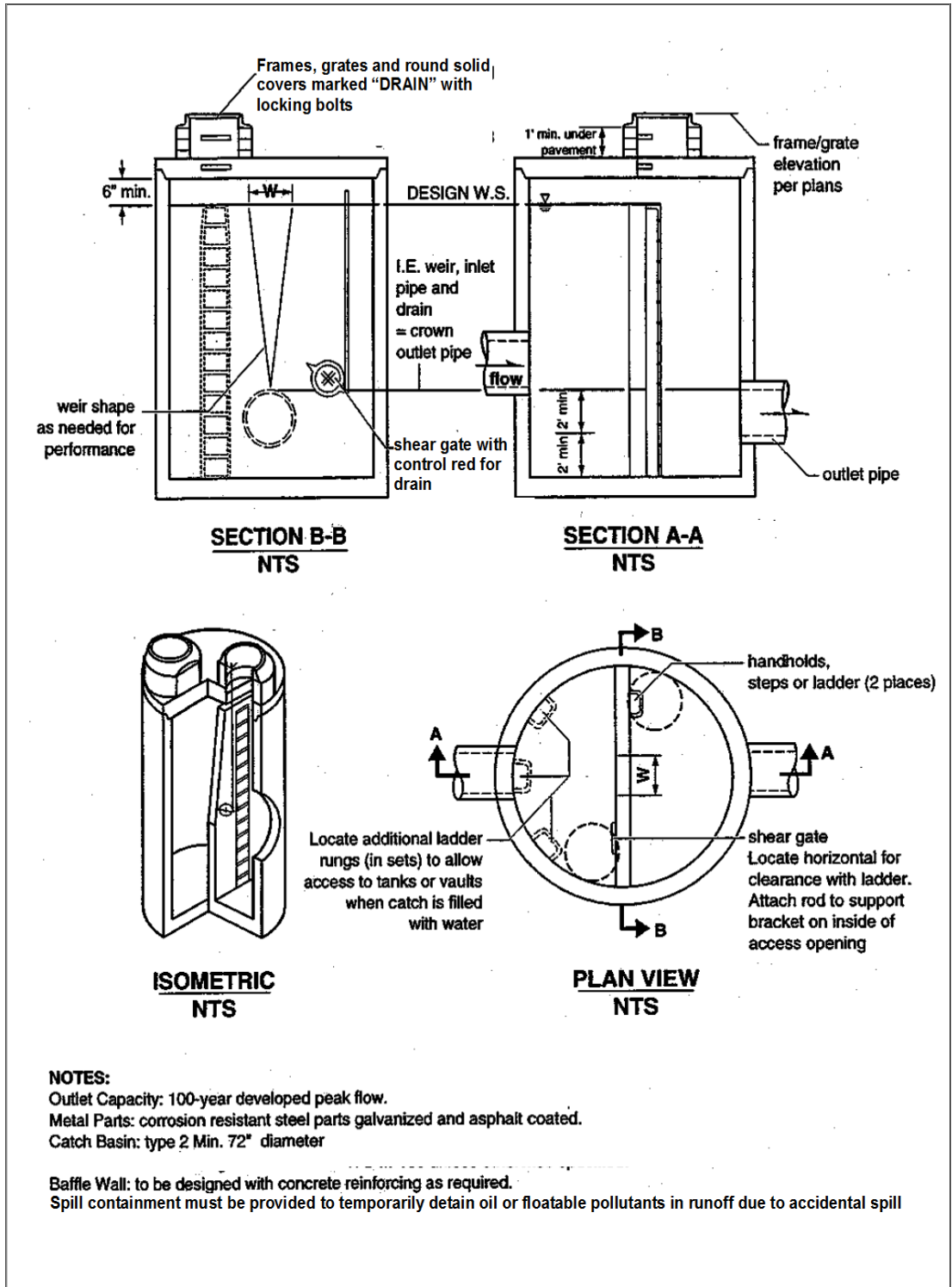


Figure 6.3: Flow Restrictor (Weir)

(Source: WA Department of Ecology)



### 6.1.4.3 Methods of Analysis

This section presents the methods and equations for design of control structure restrictor devices. Included are details for the design of orifices, rectangular sharp-crested weirs, and overflow risers. Information on other restrictor types, such as v-notch weirs, sutro weirs can be found in the SMMWW.

#### Orifices

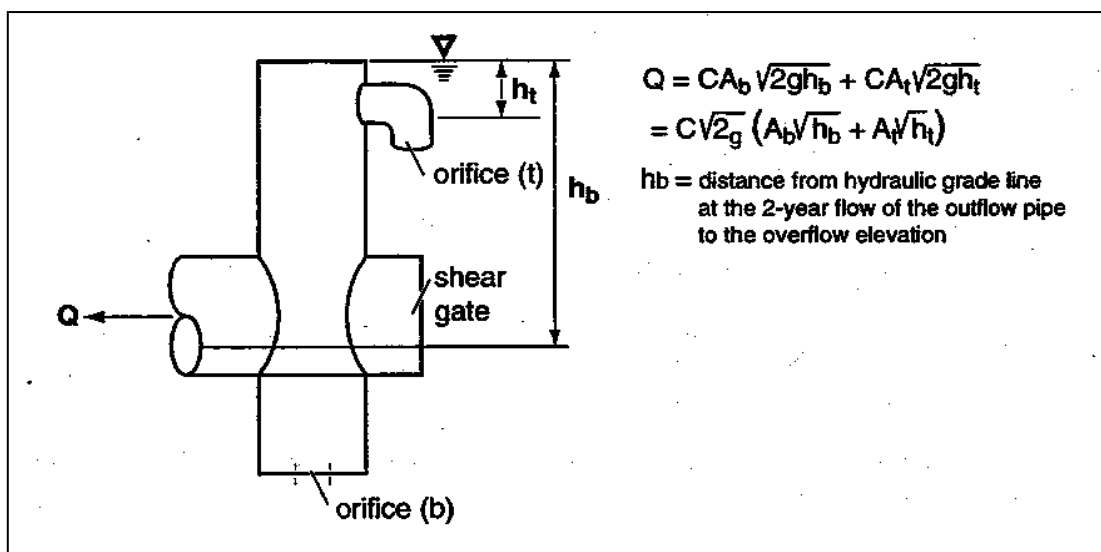
Flow-through orifice plates in the standard tee section or turn-down elbow may be approximated by the general equation:

$$Q = C A \sqrt{2gh} \quad \text{Equation 6-1}$$

Where:

- $Q$  = flow (cfs)
- $C$  = coefficient of discharge (0.62 for plate orifice)
- $A$  = area of orifice (ft<sup>2</sup>)
- $h$  = hydraulic head (ft)
- $g$  = gravity (32.2 ft/sec<sup>2</sup>)

Figure 6.4 illustrates this simplified application of the orifice equation.



**Figure 6.4: Simple Orifice**

(Source: Department of Ecology)

The diameter of the orifice is calculated from the flow. The orifice equation is often useful when expressed as the orifice diameter in inches:

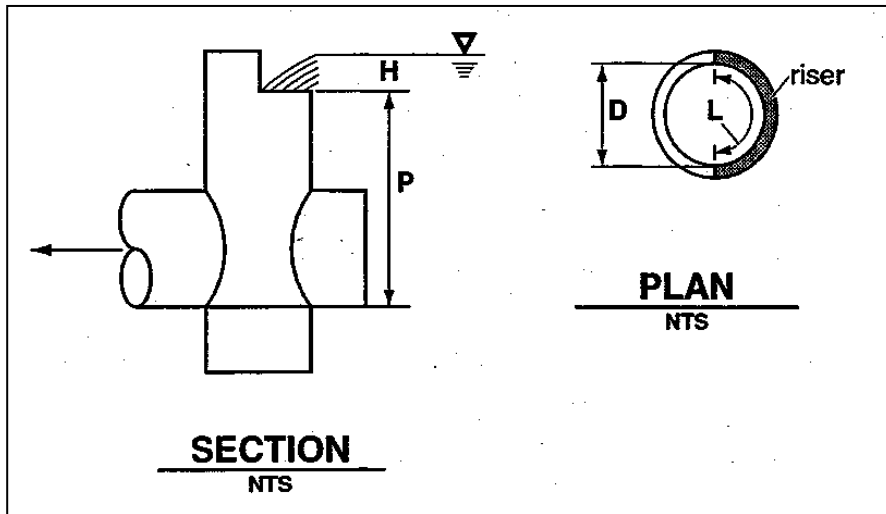
$$d = \sqrt{\frac{36.88Q}{\sqrt{h}}} \quad \text{Equation 6-2}$$

Where:

- $d$  = orifice diameter (inches)
- $Q$  = flow (cfs)
- $h$  = hydraulic head (ft)

### Rectangular Sharp-Crested Weir

The rectangular sharp-crested weir design shown in [Figure 6.5](#) may be analyzed using standard weir equations for the fully contracted condition.



**Figure 6.5: Rectangular, Sharp Crested Weir**

(Source: Department of Ecology)

$$Q = C (L - 0.2H) H^{3/2} \quad \text{Equation 6-3}$$

Where:

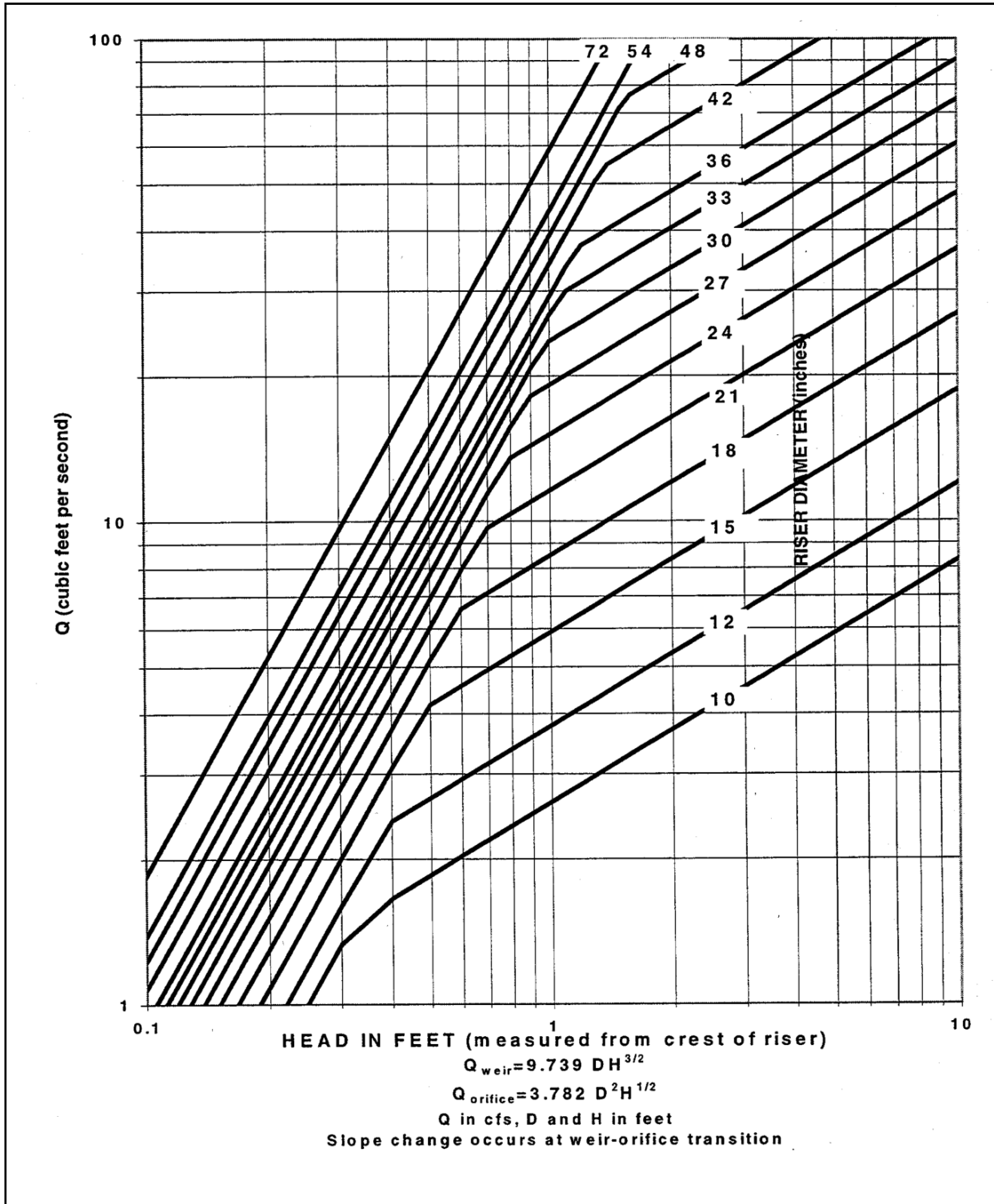
- $Q$  = flow (cfs)
- $C = 3.27 + 0.40 H/P$  (ft)
- $H, P$  are as shown above
- $L$  = length (ft) of the portion of the riser circumference as necessary not to exceed 50 percent of the circumference

- $D$  = inside riser diameter (ft)

Note that this equation accounts for side contractions by subtracting  $0.1H$  from  $L$  for each side of the notch weir.

### Riser Overflow

The nomograph in [Figure 6.6](#) can be used to determine the head (in feet) above a riser of given diameter and for a given flow (usually the 100-year peak flow for developed conditions).



**Figure 6.6: Riser Inflow Curves**

(Source: Department of Ecology)

## 6.2 Detention BMPs

### BMP D6.10 Detention Ponds

---

#### Purpose and Description

Detention ponds are surface facilities that store and release stormwater through control structures. Detention ponds can also provide for retention of stormwater through infiltration in the bottom of the pond. See [Figure 6.7](#) for a typical detention pond.

#### Cross Reference Guide

Soils Assessment	<a href="#">Book 1, Section 4.3.1.3</a> (For infiltration with detention)
Minimum Requirements	#7, #5 LID Performance Standard
Related BMPs	See <a href="#">Book 1, Chapter 3</a> to select a runoff treatment BMP meeting MR #6
Selection/Infeasibility Criteria	<a href="#">Book 1, Section 4.3.2</a>
Maintenance	<a href="#">Book 4</a>

#### Applications, Limitations, and Setbacks

Pond bottoms should be level and located a minimum of 0.5 foot (preferably 1 foot) below the inlet and outlet to provide sediment storage.

A geotechnical analysis and report must be prepared for facilities associated with slopes over 15%, or if located within 200 feet of the top of a slope steeper than 40%, or landslide hazard area. The scope of the geotechnical report should include the assessment of impoundment seepage on the stability of the natural slope where the facility will be located within the setback limits set forth in this section.

#### Setbacks

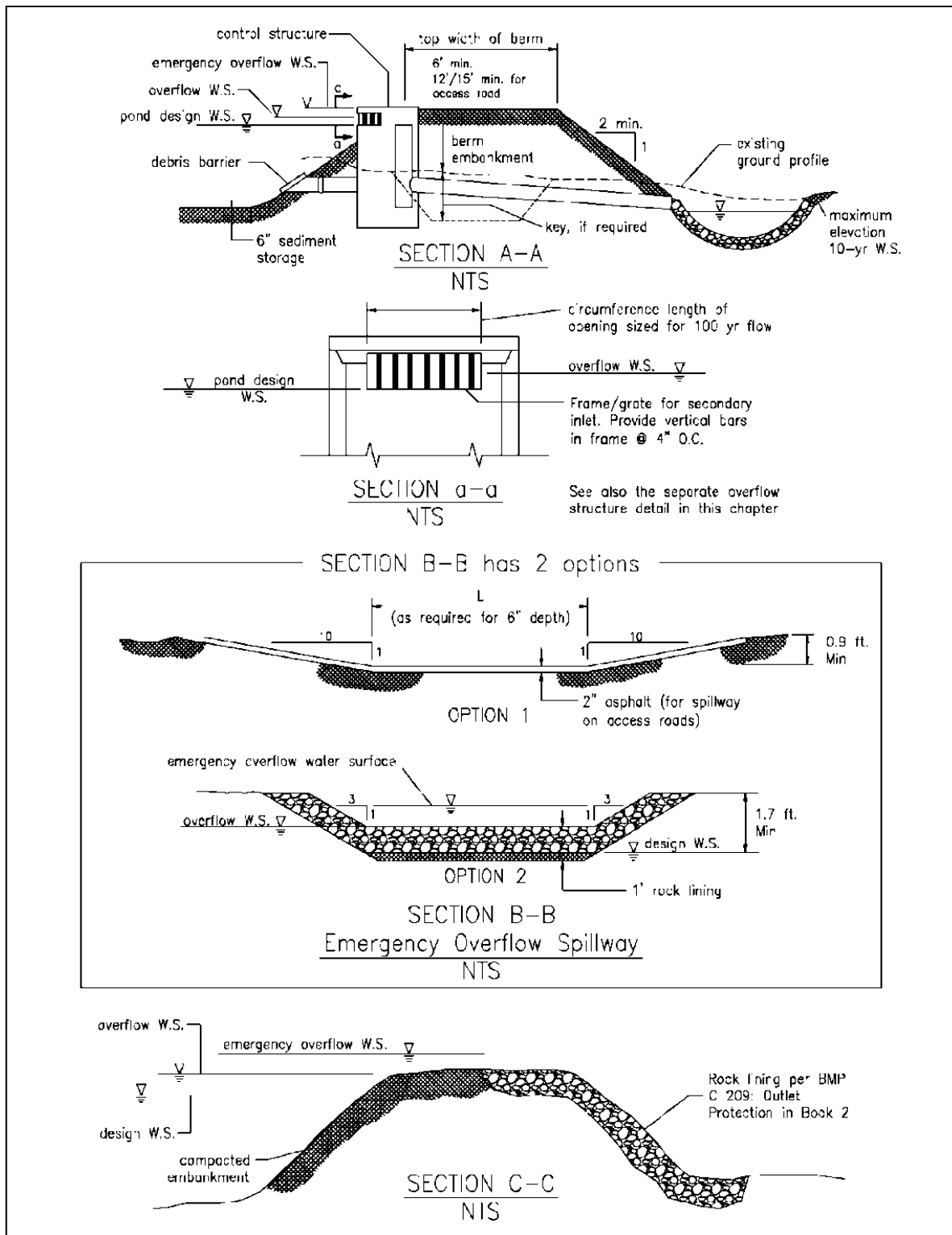
The detention pond water surface at the pond outlet invert elevation must be set back 100 feet from proposed or existing septic system drainfields

See [Section 6.1.3](#) for additional setbacks.

## Design Criteria

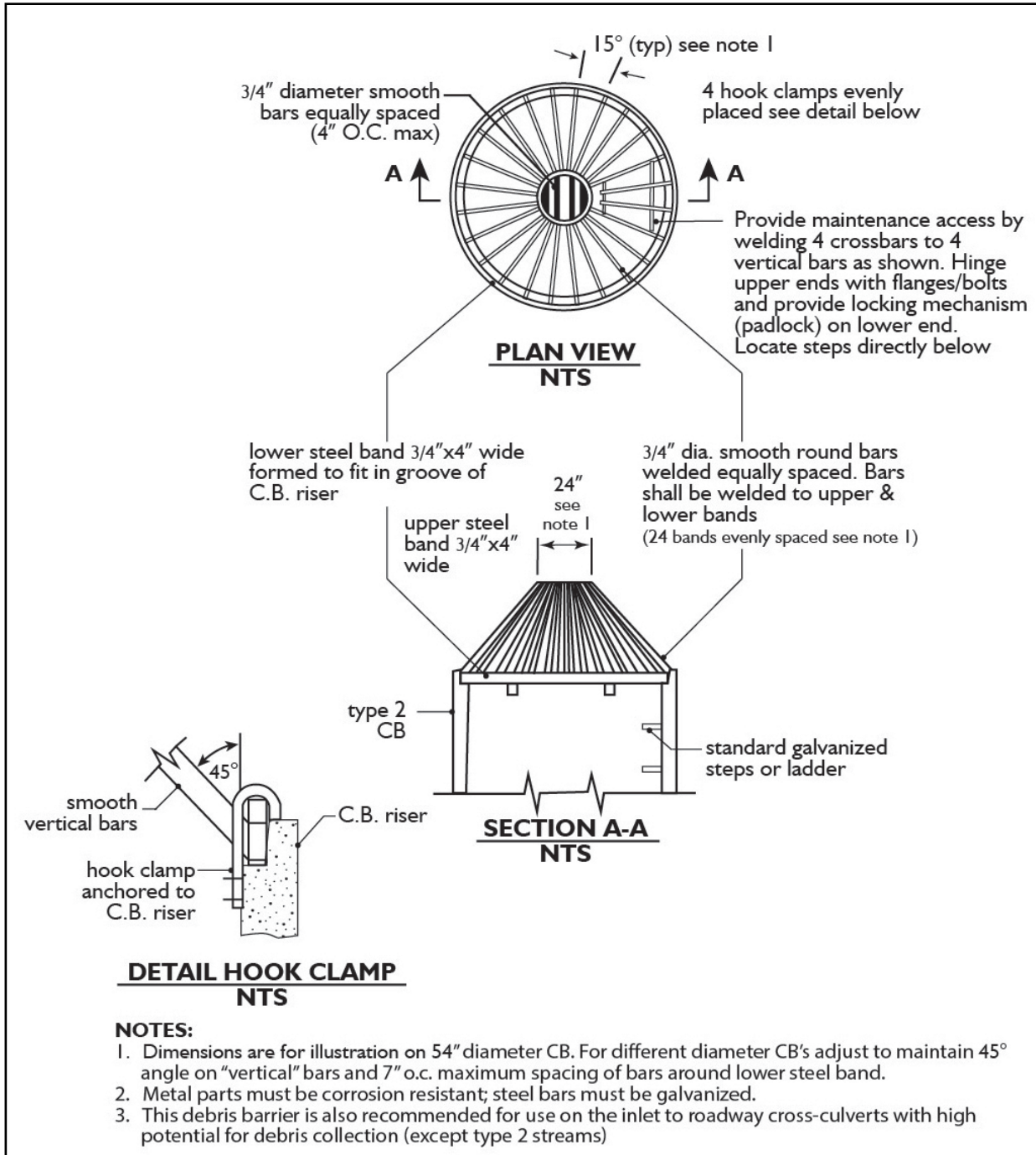
### Access

1. Provide maintenance access road(s) to the control structure and other drainage structures associated with the pond (e.g., inlet or bypass structures). Manhole and catch basin lids must be in or at the edge of the access road and at least three feet from a property line.
2. An access ramp must be provided for removal of sediment. Extend the ramp to the pond bottom if the pond bottom is greater than 1,500 square feet (measured without the ramp). If the pond bottom is less than 1,500 square feet (measured without the ramp), the ramp may end at an elevation 4 feet above the pond bottom.
3. On large, deep ponds, provide truck access to the pond bottom via an access ramp so loading can be done in the pond bottom. On small deep ponds, the truck can remain on the ramp for loading. On small shallow ponds, a ramp to the bottom may not be required if the trackhoe can load a truck parked at the pond edge or on the internal berm of a wetpond or combined pond (trackhoes can negotiate interior pond side slopes).
4. The internal berm of the pond may be used for access if all of the following apply:
  - The internal berm is no more than 4 feet above the first wetpool cell.
  - The first wetpool cell is less than 1,500 square feet (measured without the ramp).
  - The internal berm is designed to support a loaded truck, considering the berm is normally submerged and saturated.
5. Access ramps must meet the requirements for design and construction of access roads specified below.
6. If a fence is required, access should be limited by a double-posted gate or by bollards – two fixed bollards on each side of the access road and two removable bollards equally located between the fixed bollards.
7. Access roads shall be as follows:
  - A maximum grade of 15%.
  - A minimum of 40 feet outside turning radius.
  - Locate fence gates only on straight sections of road.
  - 15 feet in width on curves and 12 feet on straight sections.
  - Provide a paved apron where access roads connect to paved public roadways.
  - Access roads must be constructed with permeable pavement, gravel surface, or a modular grid pavement.



**Figure 6.7: Typical Detention Pond Sections**

(Source: redrawn from Department of Ecology) Reference only; requires detailed engineering.



**Figure 6.8: Overflow Structure**

(Source: Department of Ecology)



8. Access roads must provide access to the control structure for inspection and maintenance.
9. Any landscape plantings near entry and access road should take into account the anticipated mature height of the plant species and maintain clear access of the access at mature height. This will minimize on-going maintenance needs for pruning.

## Fencing

Fences are not required for private stormwater facilities, provided a hold-harmless agreement is provided to the county. Flow control and runoff treatment facilities that will be dedicated to Clark County shall be fenced as follows:

1. A fence is required at the emergency overflow water surface elevation, or higher, where a pond interior side slope is steeper than 3H: 1V, or where the impoundment is a wall greater than 24 inches in height. The fence need only be constructed for those slopes steeper than 3H:1V.
2. Other regulations such as the International Building Code or Uniform Building Code may require fencing of vertical walls. If more than 10 percent of slopes are steeper 3H: 1V, then the entire pond must be fenced.
3. Detention ponds on school sites must comply with safety standards developed by the Department of Health (DOH) and the Superintendent for Public Instruction (SPI). These standards include what is called a ‘non-climbable fence.’ One example of a non-climbable fence is a chain-link fence with a tighter mesh, so children cannot get a foot-hold for climbing. The designer should consult the DOH’s Office of Environmental Programs.
4. Fences shall be 6 feet in height, or a minimum of 4 feet in height if the depth of the impoundment (measured from the lowest elevation in the bottom of the impoundment, directly adjacent to the bottom of the fenced slope, up to the emergency overflow water surface) is 5 feet or less. See WSDOT Standard Plan L-2, Type 1 or Type 3 chain link fence for 6-foot fences, and WSDOT Standard Plan L-2, Type 4 or Type 6 chain link fence for 4-foot fences. Ensure that a high tension wire is used within fencing in the right-of-way or near clear zones. Top rails may be substituted where collision hazard is low.
5. Access road gates must be a minimum of 16 feet in width consisting of two swinging sections 8 feet in width. Provide additional vehicular access gates as needed to facilitate maintenance access.
6. Pedestrian access gates (if needed) should be 5 feet in width.
7. Vertical metal balusters or 9 gauge galvanized steel fabric with bonded vinyl coating can be used as fence material. For steel fabric fences, consider the following aesthetic features:

- a. Black vinyl coating. All posts, cross bars, and gates may be painted or coated the same color as the vinyl clad fence fabric.
  - b. Fence posts and rails that conform to WSDOT Standard Plan L-2 for Types 1, 3, or 4 chain link fence.
8. For metal baluster fences, Uniform Building Code standards apply.
  9. Wood board fences are not allowed.
  10. Fence gates must allow the ability for the county to add a padlock.

If the facility is not enclosed by a fence, the covers for all control structures, manholes, and catch basins shall be bolted in place.

### Side slopes

Side slopes of stormwater ponds (both public and private) shall be according to [Table 6.1](#).

**Table 6.1: Detention Pond Side slopes**

<b>Interior Side Slopes</b>		Table continues on following
All facilities with interior side slopes flatter than or equal to 3:1	Allowed	
All facilities with slopes flatter than or equal to 2:1	Allowed if: <ul style="list-style-type: none"> <li>• Side slopes don't need mowing, and</li> <li>• Erosion control and slope stability are provided</li> </ul>	
Public facilities, vertical slopes	Allowed if: <ul style="list-style-type: none"> <li>• Perimeter has less than or equal to 75% vertical slopes;</li> <li>• Vertical slopes more than two feet tall are fenced;</li> <li>• Maintenance access is adequate; and</li> <li>• Side slopes in a biofiltration treatment area are 3:1 or flatter.</li> <li>• The design is stamped by a licensed civil engineer with structural expertise.</li> </ul>	
Private facilities, slopes steeper than 3:1	Allowed if: <ul style="list-style-type: none"> <li>• Perimeter has less than or equal to 75% vertical slopes;</li> <li>• Vertical slopes more than two feet tall are fenced;</li> <li>• Long-term erosion control is provided;</li> <li>• Side slopes in a biofiltration treatment area are 3:1 or flatter; and</li> <li>• It is demonstrated that the facility can be adequately maintained.</li> </ul>	

<b>Exterior Side Slopes</b>	
All facilities with slopes flatter than or equal to 3:1	Allowed
All facilities with slopes flatter than or equal to 2:1	Allowed if: <ul style="list-style-type: none"> <li>• Side slopes don't need mowing, and</li> <li>• Erosion control and slope stability are provided</li> </ul>
Private facilities, slopes steeper than 2:1	Allowed if: <ul style="list-style-type: none"> <li>• Analyzed for stability by a geotechnical engineer</li> </ul>

## Embankments

1. Pond berm embankments higher than 6 feet must be designed by a professional engineer with geotechnical expertise.
2. For berm embankments 6 feet or less, the minimum top width should be 6 feet or as recommended by a geotechnical engineer.
3. Construct pond berm embankments on native consolidated soil (or adequately compacted and stable fill soils analyzed by a geotechnical engineer) free of loose surface soil materials, roots, and other organic debris.
4. Construct pond berm embankments greater than 4 feet in height by excavating a key equal to 50 percent of the berm embankment cross-sectional height and width, unless specified otherwise by a geotechnical engineer.
5. Embankment compaction should be accomplished in such a manner as to produce a dense, low permeability engineered fill that can tolerate post-construction settlements with a minimum of cracking. Place the embankment fill on a stable subgrade and compact to a minimum of 95% of the Standard Proctor Maximum Density, ASTM Procedure D698. Placement moisture content should lie within 1% dry to 3% wet of the optimum moisture content.
6. Construct the berm embankment of soils with the following characteristics: a minimum of 20% silt and clay, a maximum of 60% sand, a maximum of 60% silt, with nominal gravel and cobble content. Soils outside this specified range can be used, provided the design satisfactorily addresses the engineering concerns posed by these soils. The paramount concerns with these soils are their susceptibility to internal erosion or piping and to surface erosion from wave action and runoff on the upstream and downstream slopes, respectively.
7. Place anti-seepage filter-drain diaphragms on outflow pipes in berm embankments impounding water with depths greater than 8 feet at the design water surface. See Dam Safety Guidelines, Part IV, Section 3.3.B on pages 3-27 to 3-30. An electronic version of the

Dam Safety Guidelines is available in PDF format at  
<https://fortress.wa.gov/ecy/publications/summarypages/9255d.html>.

## Planting Requirements

Sod or seed exposed earth on the pond bottom and interior side slopes with a seed mixture that meets the requirements in [Table 6.2](#). Plant all remaining areas of the tract with grass or landscape and mulch with a 3-inch cover of hog fuel or shredded wood mulch mixture with a stabilizing mulch and/or tackifier. Shredded wood mulch is made from shredded tree trimmings, usually from trees cleared on site. The mulch should be free of garbage and noxious weeds and should not contain excessive resin, tannin, or other material detrimental to plant growth. Do not use construction materials, wood debris or wood treated with preservatives for producing shredded wood mulch.

**Table 6.2: Low-Growing Turf Seed Mix**

	% Weight	% Purity	% Germination
Dwarf tall fescue (several varieties) <i>Festuca arundinacea</i> var.	45	98	90
Dwarf perennial rye (Barclay) <i>Lolium perenne</i> var. <i>barclay</i>	30	98	90
Red fescue <i>Festuca rubra</i>	20	98	90
Colonial bentgrass <i>Agrostis tenuis</i>	5	98	90
<b>Add One of the Following to Mix:</b>	<b>Lbs per Acre</b>		
Poco barley <i>Hordeum vulgare</i> var <i>Poco</i>	50		
Regreen wheat x wheatgrass hybrid <i>Triticum aestivum</i> x <i>Elytrigia elongata</i>	50		

## Landscaping


Landscaping is encouraged for most stormwater tract areas (see below for areas not to be landscaped). However, if provided, landscaping should adhere to the criteria that follow so as not to hinder maintenance operations. Landscaped stormwater tracts may, in some instances, provide a recreational space. In other instances, “naturalistic” stormwater facilities may be placed in open space tracts.

Follow these guidelines if landscaping is proposed for facilities:

1. Do not plant trees or shrubs on berms meeting the criteria of dams regulated for safety.
2. Do not plant trees or shrubs within 10 feet of inlet or outlet pipes or manmade drainage structures such as spillways or flow spreaders. Avoid using species with roots that seek water, such as willow or poplar, within 50 feet of pipes or manmade structures.
3. Restrict planting on berms that impound water permanently or temporarily during storms. This restriction does not apply to cut slopes that form pond banks, only to berms.
  - a. Do not plant trees or shrubs on portions of water-impounding berms taller than four feet high. Plant only grasses on berms taller than four feet. Grasses allow unobstructed visibility of berm slopes for detecting potential dam safety problems such as animal burrows, slumping, or fractures in the berm.
  - b. Trees planted on portions of water-impounding berms less than 4 feet high must be small, not higher than 20 feet mature height, and have a fibrous root system.
4. Plant all landscape material, including grass, in high-quality topsoil. Make native underlying soils suitable for planting by amending with 4 inches of well-aged compost tilled into the subgrade. See [BMP T5.13](#) in [Chapter 2](#) for soil quality standards.
5. Soil in which trees or shrubs are planted may need additional enrichment or additional compost top-dressing. Consult a nursery, landscape professional, or arborist for site-specific recommendations based on soil testing for plant sustainability and vigor
6. For a naturalistic effect as well as ease of maintenance, plant trees or in clumps to form “landscape islands” rather than spacing evenly.
  - a. The landscaped islands should be a minimum of six feet apart, and if set back from fences or other barriers, the setback distance should also be a minimum of 6 feet. Where tree foliage extends low to the ground, the six feet setback should be counted from the outer drip line of the trees (estimated at maturity).
  - b. This setback allows a 6-foot wide mower to pass around and between clumps.
7. Evergreen or columnar deciduous trees along the west and south sides of ponds are recommended to reduce thermal heating, except that no trees or shrubs may be planted on berms meeting the criteria of dams regulated for safety. Trees should be set back so that the branches will not extend over the pond. Intent: Evergreen trees or shrubs are preferred to avoid problems associated with leaf drop. Columnar deciduous trees (e.g., Green Vase Zelkova (*Zelkova serrata* ‘Green Vase’, Cascara (*Frangula purshiana* etc.) typically have fewer leaves than other deciduous trees.

8. In addition to shade, trees and shrubs also discourage waterfowl use and the attendant phosphorus enrichment problems they cause. Setback trees so the branches will not extend over the pond.

9. Drought tolerant and native species are recommended, where feasible.

10.  Ensure that mature width of plants are taken into consideration near access roads, pedestrian walkways or manmade structures. To reduce safety and maintenance liabilities, mature branch width should not overhang these features.

#### Emergency Overflow Spillway

1. Ponds must have an emergency overflow spillway. For impoundments of 10 acre-feet or greater, the emergency overflow spillway must meet the state's dam safety requirements. For impoundments under 10 acre-feet, ponds must have an emergency overflow spillway that is sized to pass the 100-year developed peak flow in the event of total control structure failure (e.g., blockage of the control structure outlet pipe) or extreme inflows. Emergency overflow spillways are intended to control the location of pond overtopping and direct overflows back into the downstream conveyance system or other acceptable discharge point.
2. Provide emergency overflow spillways for ponds with constructed berms over 2 feet in height, or for ponds located on grades in excess of 5 percent. As an option for ponds with berms less than 2 feet in height and located at grades less than 5 percent, emergency overflow may be provided by an emergency overflow structure, such as a Type II manhole fitted with a birdcage as shown in [Figure 6.8](#). The emergency overflow structure must be designed to pass the 100-year developed peak flow, with a minimum 6 inches of freeboard, directly to the downstream conveyance system or another acceptable discharge point. Where an emergency overflow spillway would discharge to a slope steeper than 15%, consideration should be given to providing an emergency overflow structure in addition to the spillway.
3. Armor the emergency overflow spillway with riprap in conformance with [BMP C209: Outlet Protection](#), see [Book 2, Chapter 8](#). The spillway must be armored full width, beginning at a point midway across the berm embankment and extending downstream to where emergency overflows re-enter the conveyance system.
4. Emergency overflow spillway designs must be analyzed as broad-crested trapezoidal weirs as described in the following section. Either one of the weir sections shown in [Figure 6.7](#) may be used.
5. Spillways shall not be blocked by features such as fences that may trap leaves and other floating debris.
6. A minimum of six-inches of freeboard shall be provided above the 100-year water surface elevation.

## Emergency Overflow Spillway Capacity

For impoundments under 10-acre-feet, the emergency overflow spillway weir section must be designed to pass the 100-year runoff event for developed conditions assuming a broad-crested weir. The broad-crested weir equation for the spillway section in [Figure 6.9](#), for example, would be:

$$Q_{100} = C (2g)^{1/2} \left[ \frac{2}{3} LH^{3/2} + \frac{8}{15} (\text{Tan } \theta) H^{5/2} \right] \quad \text{Equation 6-4}$$

Where:

- $Q_{100}$  = peak flow for the 100-year runoff event (cfs)
- $C$  = discharge coefficient (0.6)
- $g$  = gravity (32.2 ft/sec<sup>2</sup>)
- $L$  = length of weir (ft)
- $H$  = height of water over weir (ft)
- $\theta$  = angle of side slopes

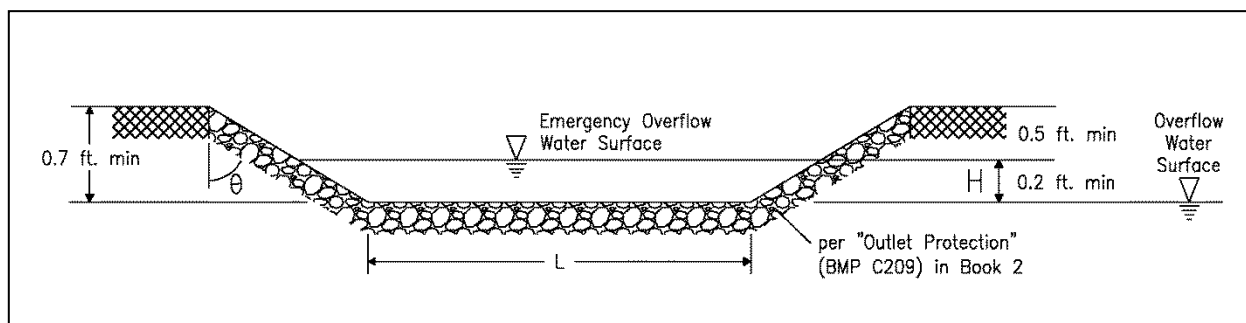
$Q_{100}$  is either the peak 10-minute flow computed from the 100-year, 24-hour storm and a Type 1A distribution, or the 100-year, 1-hour flow, indicated by an approved continuous flow model, multiplied by a factor of 1.6.

Assuming  $C = 0.6$  and  $\text{Tan } \theta = 3$  (for 3:1 slopes), the equation becomes:

$$Q_{100} = 3.21 [LH^{3/2} + 2.4 H^{5/2}] \quad \text{Equation 6-5}$$

To find width  $L$  for the weir section, the equation is rearranged to use the computed  $Q_{100}$  and trial values of  $H$  (0.2 feet minimum):

$$L = [Q_{100} / (3.21 H^{3/2})] - 2.4 H \text{ or } 6 \text{ feet minimum} \quad \text{Equation 6-6}$$



**Figure 6.9: Weir Section for Emergency Overflow Spillway**

(Source: redrawn from Department of Ecology)

## Detention Ponds in Infiltrative Soils

Detention ponds may be sited on soils that are sufficiently permeable for a properly functioning infiltration system. These detention ponds have a surface discharge and may also utilize infiltration as a second pond outflow. Detention ponds sized with infiltration as a second outflow must meet all soils assessment requirements described in [Book 1, Section 4.3](#) and [Book 2, Section 5.1](#) for infiltration basins, including a soils report, testing, groundwater protection, presettling, and construction techniques.



## BMP D6.20 Detention Tanks

---

### Purpose and Description

Detention tanks are underground storage facilities typically constructed with large diameter corrugated metal pipe.

### Cross Reference Guide

See [BMP D6.10 Detention Ponds](#)

### Applications, Limitations, and Setbacks

Tanks must be designed as flow-through systems with manholes in line (see [Figure 6.10](#)) to promote sediment removal and facilitate maintenance. Tanks may be designed as back-up systems if preceded by water quality facilities, since little sediment should reach the inlet/control structure and low head losses can be expected because of the proximity of the inlet/control structure to the tank.

#### Setbacks

Facilities shall be a minimum of 20 feet from any structure, property line, and from any septic drainfield.

All facilities must be a minimum of 50 feet from the top of any steep (greater than 15%) slope. A geotechnical analysis and report must be prepared addressing the potential impact of the facility on a slope steeper than 15%.

See [Section 6.1.3](#) for additional setbacks.

### Design Criteria

Typical design criteria are as follows:

1. Locate the detention tank bottom 0.5 feet below the inlet and outlet to provide dead storage for sediment.
2. Use a 36-inch minimum pipe diameter.
3. Tanks larger than 36 inches may be connected to each adjoining structure with a short section (2-foot maximum length) of 36-inch minimum diameter pipe.
4. Design outflow control structures per [Section 6.1.4](#).

Note: Control and access manholes should have additional ladder rungs to allow ready access to all tank access pipes when the catch basin sump is filled with water.

## Materials

Galvanized metals leach zinc into the environment, especially in standing water situations. This can result in zinc concentrations that can be toxic to aquatic life. Therefore, use of galvanized materials in stormwater facilities and conveyance systems is discouraged. Where other metals, such as aluminum or stainless steel, or plastics are available, they should be used.

Pipe material, joints, and protective treatment for tanks should be in accordance with Section 9.05 of the *WSDOT/APWA Standard Specification*.

## Structural Stability

Tanks must meet structural requirements for overburden support and traffic loading if appropriate. Accommodate H-20 live loads for tanks lying under parking areas and access roads. Design metal tank end plates for structural stability at maximum hydrostatic loading conditions. Flat end plates generally require thicker gage material than the pipe and/or require reinforcing ribs. Place tanks on stable, well consolidated native material with a suitable bedding. Do not place tanks in fill slopes, unless analyzed in a geotechnical report for stability and constructability.

## Buoyancy

In moderately pervious soils where seasonal groundwater may induce flotation, balance buoyancy tendencies by either ballasting with backfill or concrete backfill, providing concrete anchors, increasing the total weight, or providing subsurface drains to permanently lower the groundwater table. Calculations that demonstrate stability must be documented.

## Access

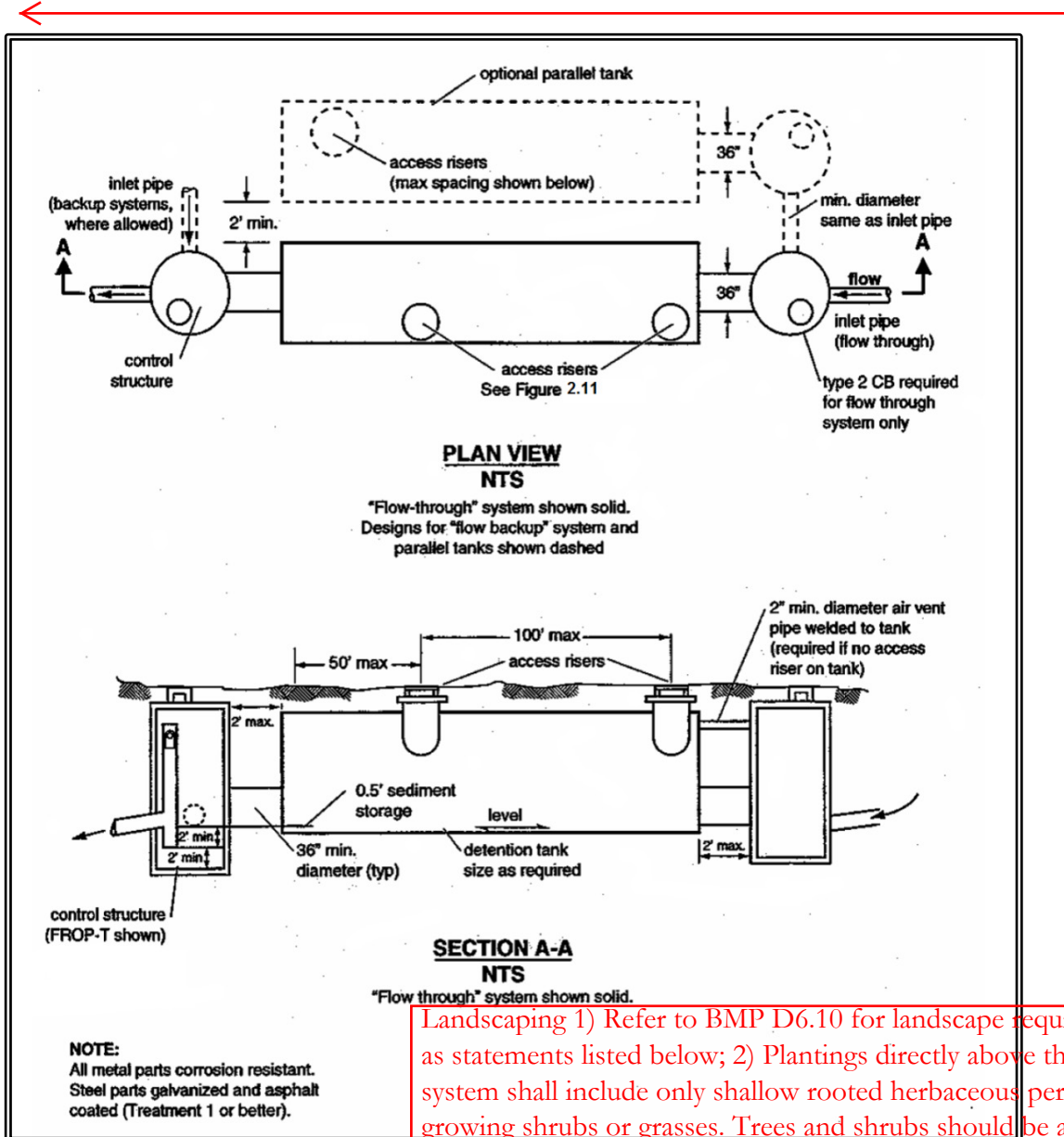
The following guidelines for access may be used.

1. The maximum depth from finished grade to tank invert should be 20 feet.
2. Position access openings a maximum of 50 feet from any location within the tank.
3. All tank access openings may have round, solid locking lids (usually 1/2 to 5/8-inch diameter Allen-head cap screws).
4. Thirty-six-inch minimum diameter CMP riser-type manholes ([Figure 6.11](#)) of the same gage as the tank material may be used for access along the length of the tank and at the upstream terminus of the tank in a backup system. The top slab is separated (1-inch minimum gap) from the top of the riser to allow for deflections from vehicle loadings without damaging the riser tank.
5. Make all tank access openings readily accessible by maintenance vehicles.

- Tanks must comply with the OSHA confined space requirements, which include clearly marking entrances to confined space areas. This may be accomplished by hanging a removable sign in the access riser(s), just under the access lid.

**Access Roads**

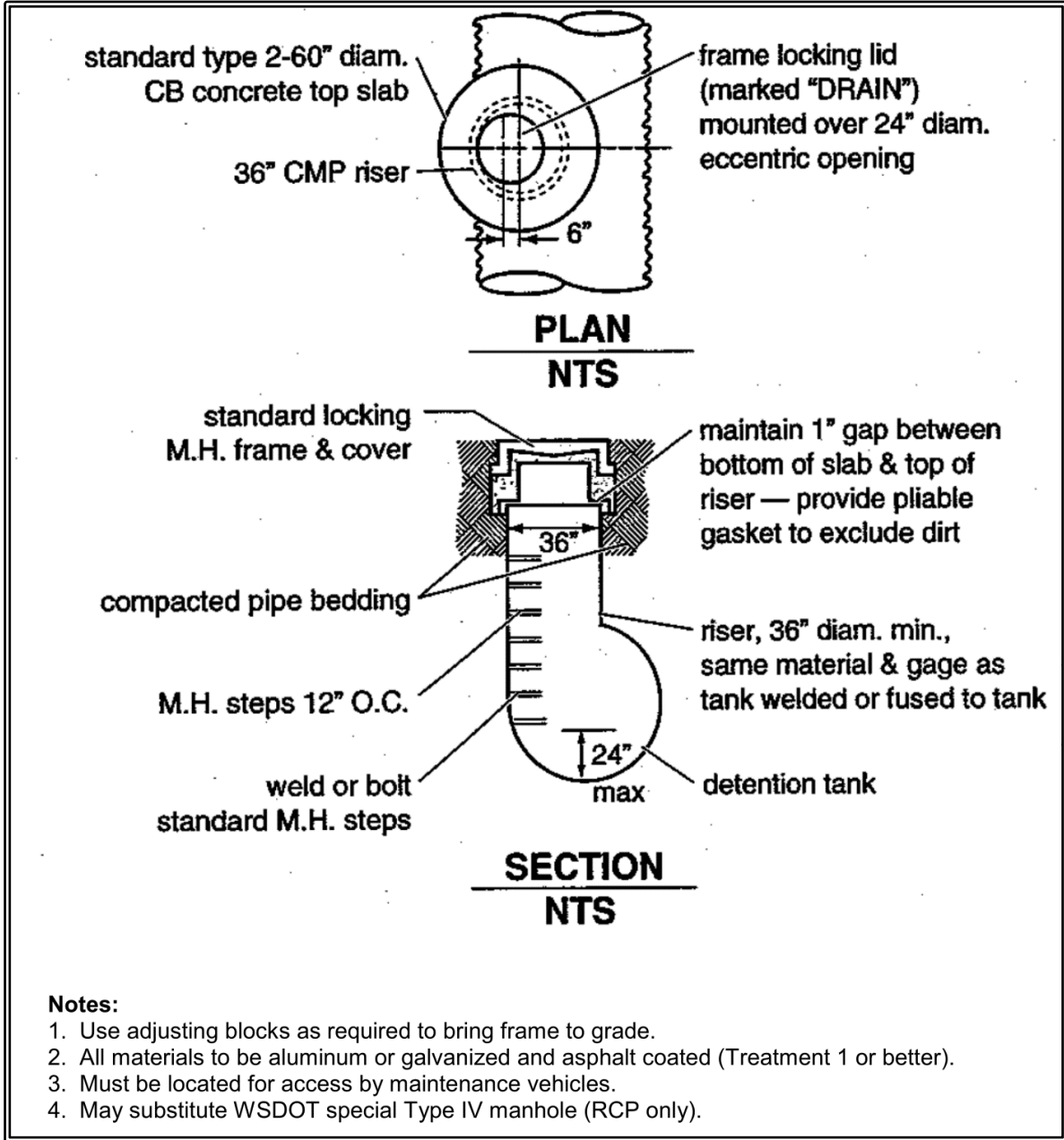
Access roads are needed to all detention tank control structures and risers. Design and construct access roads as specified for detention ponds.



**Figure 6.10: Typical Detention Tank**

(Source: SMMWW)

Landscaping 1) Refer to BMP D6.10 for landscape requirements, as well as statements listed below; 2) Plantings directly above the detention tank system shall include only shallow rooted herbaceous perennials, low growing shrubs or grasses. Trees and shrubs should be avoided to minimize risk of roots impeding storage volume capacity and structural integrity of the underground system. Plantings should not include varieties that are water seeking such as sedges or rushes; and, 3) Avoid any plantings around the perimeter of the detention tank that will cause root encroachment into the tank storage system. Large trees should be planted a minimum of 10' from the edge of the detention tank system.



**Figure 6.11: Detention Tank Access Detail**

(Source: SMMWW)

## BMP D6.30 Detention Vaults

---

### Purpose and Description

Detention vaults are box-shaped underground storage facilities typically constructed with reinforced concrete. A standard detention vault detail is shown in [Figure 6.12](#).

### Cross Reference Guide

See [BMP D6.10 Detention Ponds](#)

### Applications, Limitations, and Setbacks

Detention vaults may be designed as flow-through systems with bottoms level (longitudinally) or sloped toward the inlet to facilitate sediment removal.

#### Setbacks

It is recommended that facilities be a minimum of 20 feet from any structure, property line, and any critical area buffer and from any septic drain field.

All facilities must be a minimum of 50 feet from the top of any steep (greater than 15%) slope. A geotechnical analysis and report must be prepared addressing the potential impact of the facility on a slope steeper than 15%.

See [Section 6.1.3](#) for additional setbacks.

### Design Criteria

#### General

Typical design guidelines are as follows:

1. Maximize the distance between the inlet and outlet as feasible.
2. The detention vault bottom may slope at least 5 percent from each side towards the center, forming a broad “v” to facilitate sediment removal. More than one “v” may be used to minimize vault depth. However, the vault bottom may be flat with 0.5-1 foot of sediment storage if removable panels are provided over the entire vault. It is recommended that the removable panels be at grade, have stainless steel lifting eyes, and weigh no more than 5 tons per panel.
3. Elevate the invert elevation of the outlet above the bottom of the vault to provide an average 6 inches of sediment storage over the entire bottom. Also, elevate the outlet a minimum of 2 feet above the orifice to retain oil within the vault.

4. Details of outflow control structures are given in [Section 6.1.4](#).

## Materials

Minimum 3,000 psi structural reinforced concrete may be used for detention vaults. Provide all construction joints with water stops.

## Structural Stability

All vaults must meet structural requirements for overburden support and H-20 traffic loading (See Standard Specifications for Highway Bridges, 1998 Interim Revisions, American Association of State Highway and Transportation Officials). Vaults located under roadways must meet Clark County's live load requirements. Design cast-in-place wall sections as retaining walls. Structural designs for cast-in-place vaults must be stamped by a licensed civil engineer with structural expertise. Place vaults on stable, well-consolidated native material with suitable bedding. Do not place vaults in fill slopes, unless analyzed in a geotechnical report for stability and constructability.

## Access

Provide access over the inlet pipe and outlet structure. Use the following guidelines for access.

1. Position access openings a maximum of 50 feet from any location within the tank. Additional access points may be needed on large vaults. Provide access to each "v" if more than one "v" is provided in the vault floor.
2. For vaults with greater than 1,250 square feet of floor area, provide a 5' by 10' removable panel over the inlet pipe (instead of a standard frame, grate and solid cover). Or, provide a separate access vault.
3. For vaults under roadways, locate the removable panel outside the travel lanes, or provide multiple standard locking manhole covers. Ladders and hand-holds need only be provided at the outlet pipe and inlet pipe, and as needed to meet OSHA confined space requirements. Vaults providing manhole access at 12-foot spacing need not provide corner ventilation pipes as specified in Item 10 below.
4. All access openings, except those covered by removable panels, may have round, solid locking lids, or 3-foot square, locking diamond plate covers.
5. Vaults with widths 10 feet or less must have removable lids. All underground vault systems require access via a vault door, not manhole, for worker safety and access/usability.
6. The maximum depth from finished grade to the vault invert should be 20 feet.

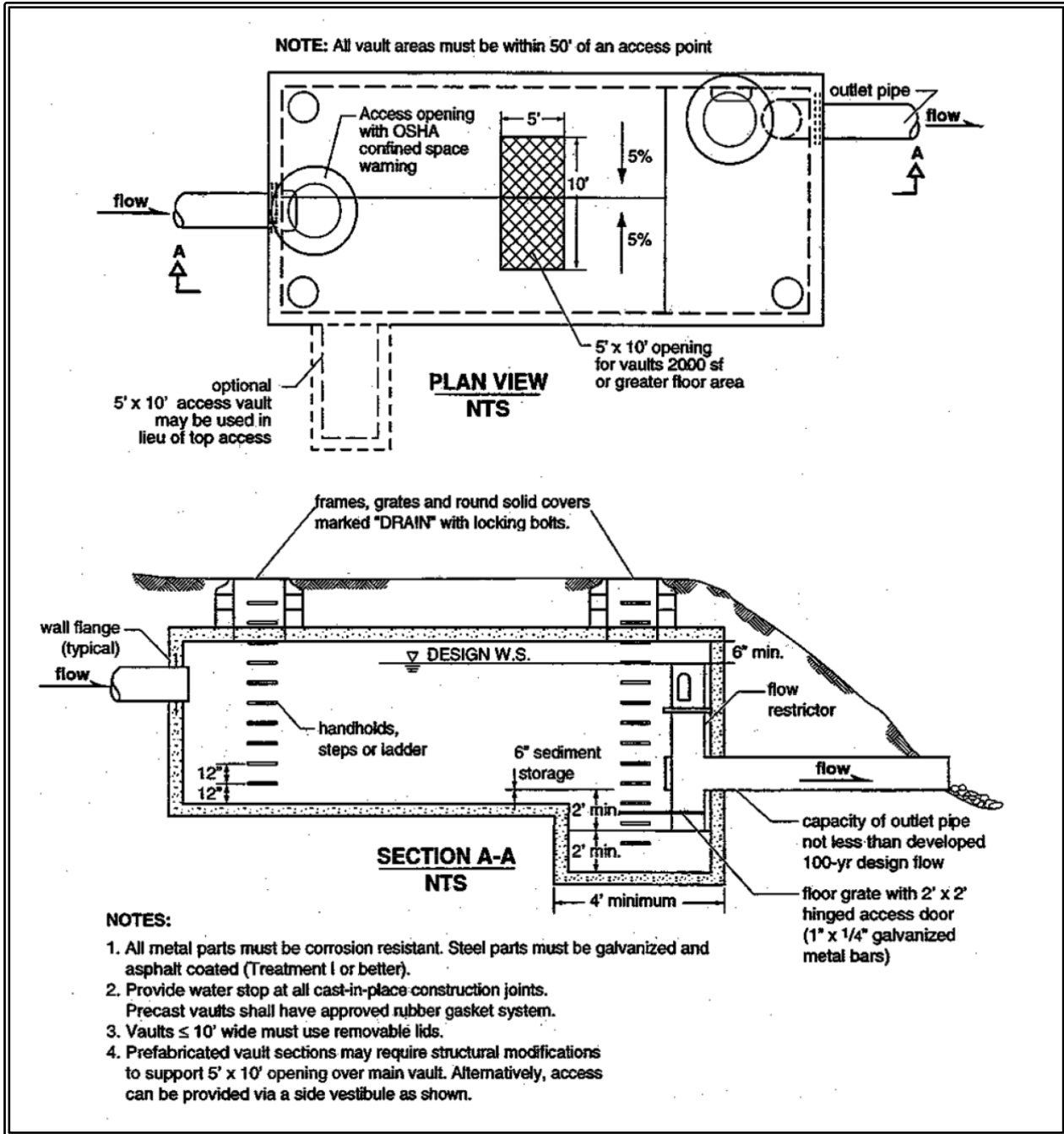
7. Provide internal structural walls of large vaults with openings sufficient for maintenance access between cells. Size and situate the openings to allow access to the maintenance “v” in the vault floor.
8. The minimum internal height should be 7 feet from the highest point of the vault floor (not sump), and the minimum width should be 4 feet. However, concrete vaults may be a minimum 3 feet in height and width if used as tanks with access manholes at each end, and if the width is no larger than the height. Also, the minimum internal height requirement may not be needed for any areas covered by removable panels.
9. Vaults must comply with the OSHA confined space requirements, which include clearly marking entrances to confined space areas. This may be accomplished by hanging a removable sign in the access riser(s), just under the access lid.
10. Provide ventilation pipes (minimum 12-inch diameter or equivalent) in all four corners of vaults to allow for artificial ventilation prior to entry of maintenance personnel into the vault. Or, provide removable panels over the entire vault.

### Access Roads

Access roads are needed to the access panel (if applicable), the control structure, and at least one access point per cell, and they may be designed and constructed as specified for detention ponds, [BMP D6.10](#) in [Section 6.2](#).

### Right-of-Way

Right-of-way is needed for detention vaults maintenance. It is recommended that any tract not abutting public right-of-way should have a 15 to 20-foot wide extension of the tract to accommodate an access road to the facility.



**Figure 6.12: Typical Detention Vault**

(Source: SMMWW)



## Additional Detention BMPs

---

This section presents other design options for detaining flows to meet flow control facility requirements. Note that these options must be served by a flow control structure that provides flow control meeting the standards in Minimum Requirement #7.

### Use of Parking Lots for Additional Detention

Private parking lots may be used to provide additional detention volume for runoff events greater than the 2-year runoff event provided all of the following are met:

1. The depth of water detained does not exceed 1 foot at any location in the parking lot for runoff events up to and including the 100-year event.
2. The gradient of the parking lot area subject to ponding is 1 percent or greater.
3. The emergency overflow path is identified and noted on the engineering plan. The overflow must not create a significant adverse impact to downhill properties or drainage system.
4. Fire lanes used for emergency equipment are free of ponding water for all runoff events up to and including the 100-year event.

### Use of Roofs for Detention

Detention ponding on roofs of structures may be used to meet flow control requirements provided all of the following are met:

1. The roof support structure is analyzed by a structural engineer to address the weight of ponded water.
2. The roof area subject to ponding is sufficiently waterproofed to achieve a minimum service life of 30 years.
3. The minimum pitch of the roof area subject to ponding is 1/4-inch per foot.
4. An overflow system is included in the design to safely convey the 100-year peak flow from the roof.
5. A mechanism is included in the design to allow the ponding area to be drained for maintenance purposes or in the event the restrictor device is plugged.

## BMP D6.40: Combined Detention and Wetpool Facilities

---

### Purpose and Description

Combined detention and water quality wetpool facilities have the appearance of a detention facility but contain a permanent pool of water as well. The following design procedures, requirements, and recommendations cover differences in the design of the stand-alone water quality facility when combined with detention storage. The following combined facilities are addressed:

- Detention/wetpond (basic and large)
- Detention/wetvault
- Detention/stormwater wetland

The detention portion of the facility shall meet the design criteria and sizing procedures set forth in [Section 6.1](#).

### Cross Reference Guide

Soils Assessment	Not Applicable
Minimum Requirements	#6 and #7
Related BMPs	None
Selection/Infeasibility Criteria	<a href="#">Book 1, Section 3.2</a> and <a href="#">Section 4.3.2</a>
Maintenance	<a href="#">Book 4</a>

### Applications, Limitations and Setbacks

Combined detention and water quality facilities are very efficient for sites that also have both detention and water quality treatment requirements. The water quality facility may often be placed beneath the detention facility without increasing the facility surface area. However, the fluctuating water surface of the live storage will create unique challenges for plant growth and for aesthetics alike.

The basis for pollutant removal in combined facilities is the same as in the stand-alone WQ facilities. However, in the combined facility, the detention function creates fluctuating water levels and added turbulence. For simplicity, the positive effect of the extra live storage volume and the negative effect of increased turbulence are assumed to balance, and are thus ignored when sizing the wetpool volume. For the combined detention/stormwater wetland, criteria that limit the extent of water level fluctuation are specified to better ensure survival of the wetland plants.

Unlike the wetpool volume, the live storage component of the facility should be provided above the seasonal high water table.

## Design Criteria

### Combined Detention and Wetpool

#### Sizing Procedure

The sizing procedure for combined detention and wetpools are identical to those outlined for wetpools and for detention facilities. The wetpool volume for a combined facility shall be equal to or greater than the total volume of runoff from the 6-month, 24-hour storm event. Alternatively, use the Water Quality Design Storm Volume estimated by an approved continuous flow model. Follow the standard procedure specified in [Section 6.1](#) and guidance documents for use of an approved continuous flow model to size the detention portion of the pond.

#### Geometry

- The wetpool and sediment storage volumes shall not be included in the required detention volume.
- The Wetpool Geometry criteria for wetpools (see [BMP T10.10](#)) shall apply with the following modifications/clarifications:

Criterion 1: The permanent pool may be made shallower to take up most of the pond bottom, or deeper and positioned to take up only a limited portion of the bottom. Note, however, that having the first wetpool cell at the inlet allows for more efficient sediment management than if the cell is moved away from the inlet. Wetpond criteria governing water depth must, however, still be met. See [Figure 6.15](#) for two possibilities for wetpool cell placement.

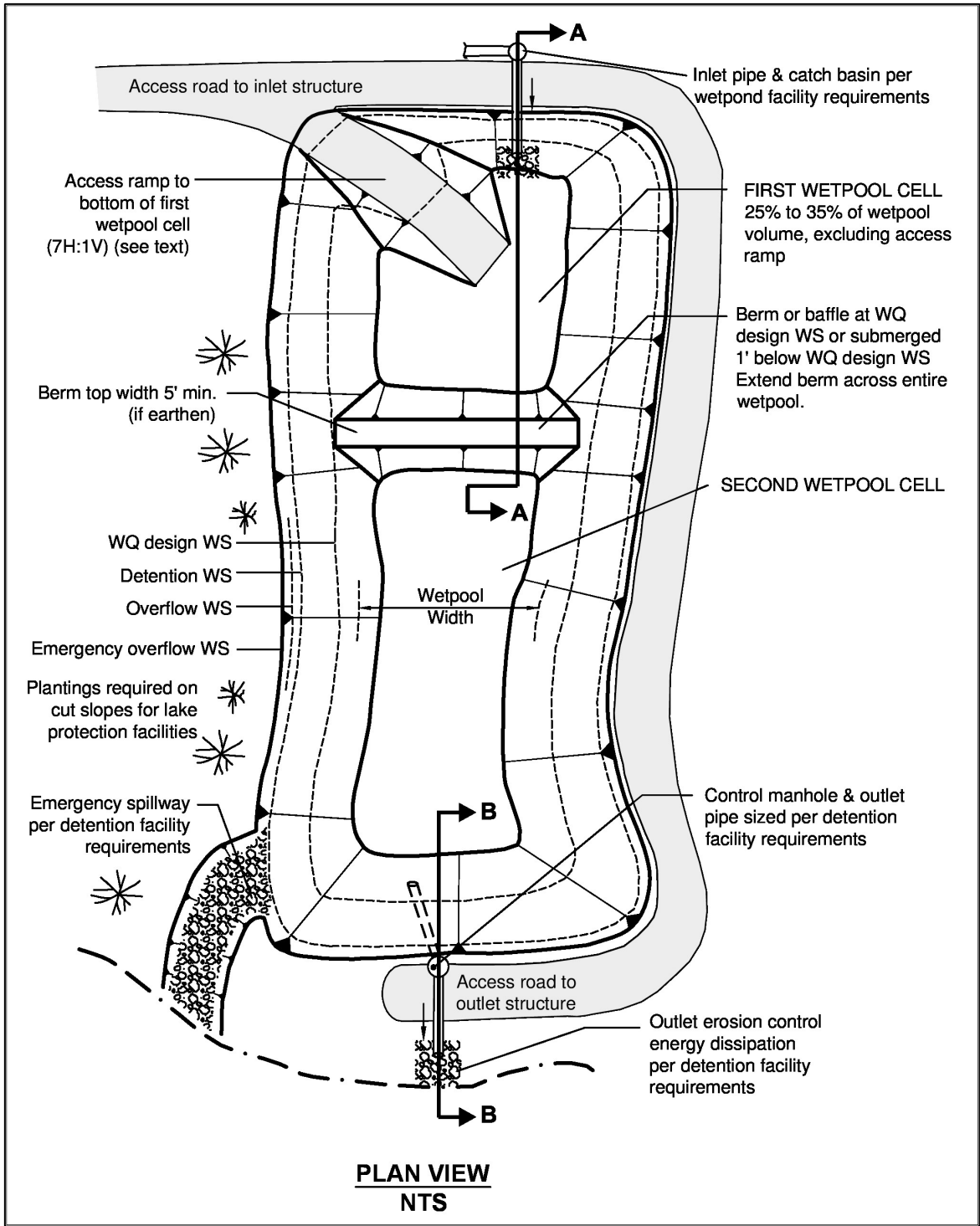
Intent: This flexibility in positioning cells is provided to allow for multiple use options, such as volleyball courts in live storage areas in the drier months.

Criterion 2: The minimum sediment storage depth in the presettling basin is 1 foot. The 6 inches of sediment storage required for detention ponds does not need to be added to this, but 6 inches of sediment storage must be added to the second cell to comply with the detention sediment storage requirement.

- The access and maintenance road could be extended along the full length of the facility and could double as a nature trail or picnic areas. Part of the access road should extend near the water's edge to allow visual access to the pond year-round (for safety purposes). Plantings should be a minimum of 8 feet from the edge of the access road to limit plant overgrowth onto the access route and maintain good visibility for access and use. Placing finely ground bark or other natural material over the road surface would render it more pedestrian-friendly.

Berms, Baffles, and Slopes

Same as for wetponds (see [BMP T10.10](#)).



**Figure 6.13: Combined Detention and Wetpond - Plan View**

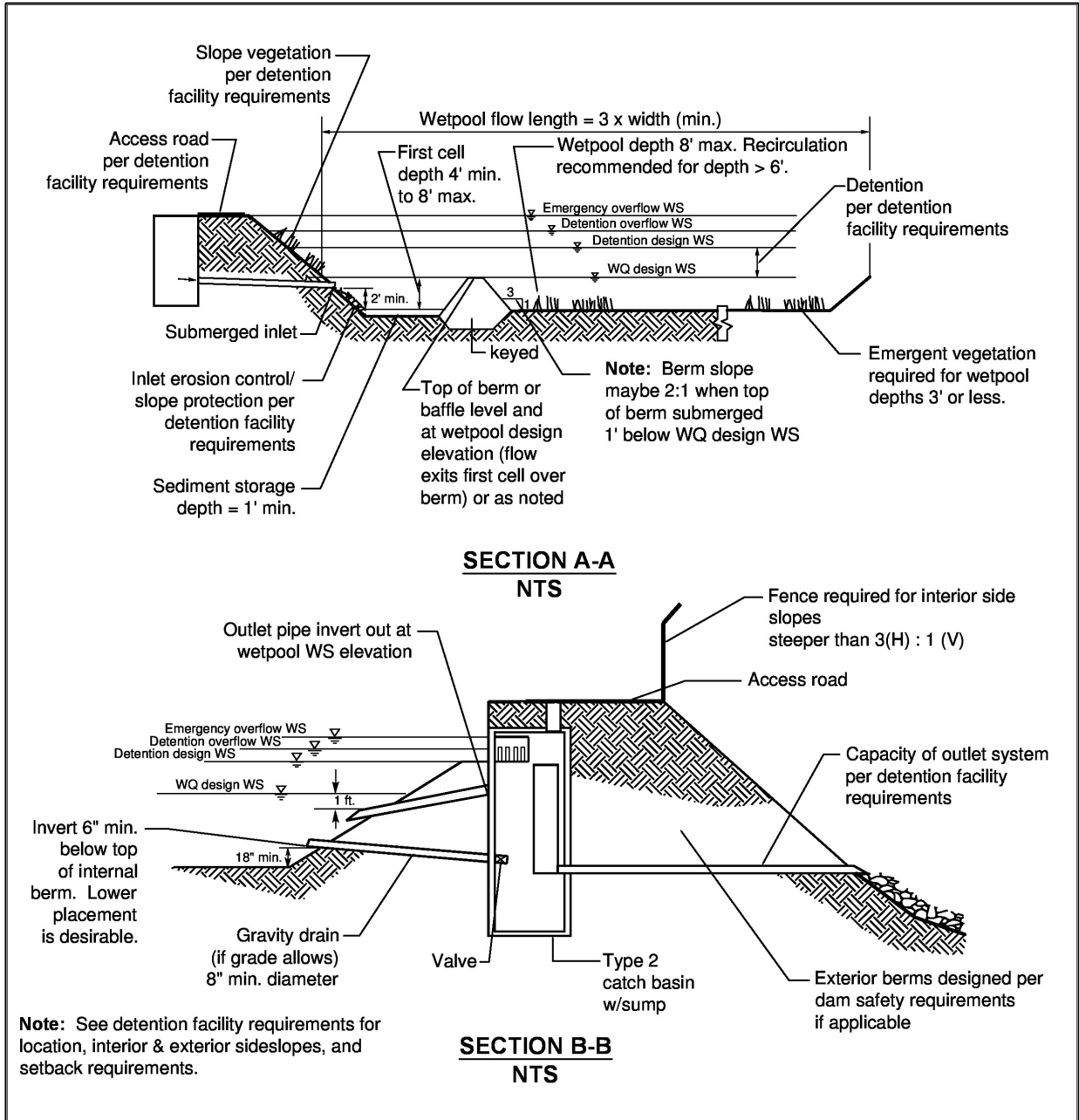
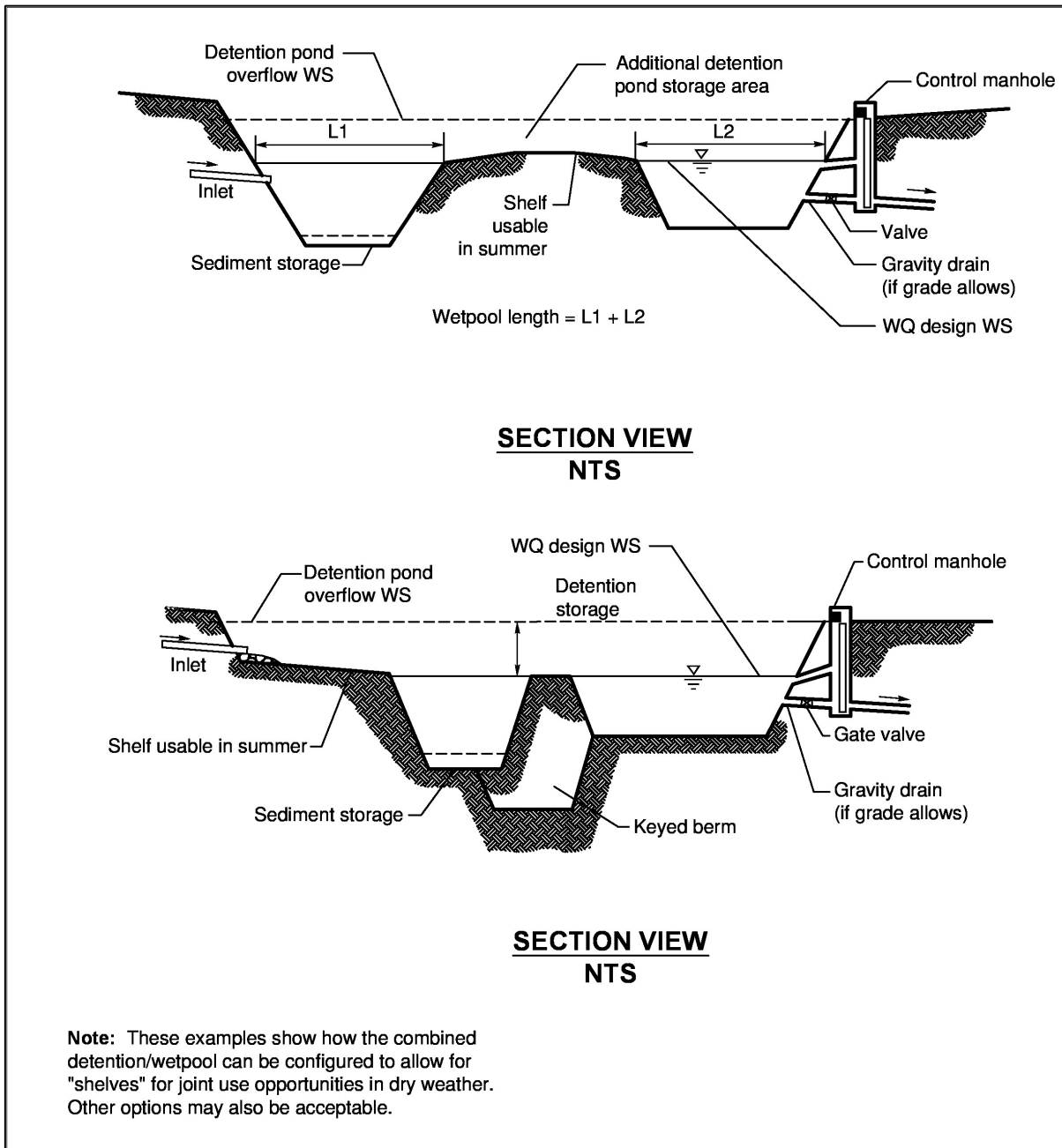


Figure 6.14: Combined Detention and Wetpond - Section View

(Source: Department of Ecology)



**Figure 6.15: Alternative Configurations of Detention and Wetpool Areas**

(Source: SMMWW)

Inlet and Outlet

The "Inlet and Outlet" criteria for wetpools shall apply with the following modifications:

- A sump must be provided in the outlet structure of combined ponds.
- The detention flow restrictor and its outlet pipe shall be designed according to the requirements for detention ponds (see [Section 6.1.4](#)).

### Access and Setbacks

Same as for wetponds.

### Planting Requirements

Same as for wetponds.

## **Combined Detention and Wetvault**

The sizing procedure for combined detention and wetvaults is identical to those outlined for wetvaults and for detention facilities. The wetvault volume for a combined facility shall be equal to or greater than the total volume of runoff from the 6-month, 24-hour storm event. Alternatively, use the Water Quality Design Storm Volume estimated by an approved continuous flow model to size the wetpool portion of vault. Follow the standard procedure specified in [Book 1](#) for use of an approved continuous flow model to size the detention portion of the vault.

The design criteria for detention vaults and wetvaults must both be met, except for the following modifications or clarifications:

- The minimum sediment storage depth in the presettling basin shall average 1-foot. The 6 inches of sediment storage required for detention vaults does not need to be added to this, but 6 inches of sediment storage must be added to the second cell to comply with detention vault sediment storage requirements.
- The oil retaining baffle shall extend a minimum of 2 feet below the WQ design water surface.

Intent: The greater depth of the baffle in relation to the WQ design water surface compensates for the greater water level fluctuations experienced in the combined vault. The greater depth is deemed prudent to better ensure that separated oils remain within the vault, even during storm events.

Note: If a vault is used for detention as well as water quality control, the facility may not be modified to function as a baffle oil/water separator as allowed for wetvaults in [BMP T10.20](#). This is because the added pool fluctuation in the combined vault does not allow for the quiescent conditions needed for oil separation.

## **Combined Detention and Stormwater Wetland**

The sizing procedure for combined detention and stormwater wetlands is identical to those outlined for stormwater wetlands and for detention facilities. Follow the procedure specified in [BMP T10.30](#) to determine the stormwater wetland size. Follow the standard procedure specified in [Section 6.1](#) to size the detention portion of the wetland.

The design criteria for detention ponds and stormwater wetlands must both be met, except for the following modifications or clarifications:

- The Wetland Geometry criteria for stormwater wetlands (see [BMP T10.30](#)) are modified as follows:
  - The minimum sediment storage depth in the presettling basin is 1 foot. The 6 inches of sediment storage required for detention ponds does not need to be added to this, nor does the 6 inches of sediment storage in the second cell of detention ponds need to be added.

Intent: Since emergent plants are limited to shallower water depths, the deeper water created before sediments accumulate is considered detrimental to robust emergent growth. Therefore, sediment storage is confined to the presettling basin which functions as a presettling cell.

The Inlet and Outlet criteria for wetponds shall apply with the following modifications:

- A sump must be provided in the outlet structure of combined facilities.
- The detention flow restrictor and its outlet pipe shall be designed according to the requirements for detention ponds (see [Section 6.1.74](#)).
- The Planting Requirements for stormwater wetlands are modified to use the following plants which are better adapted to water level fluctuations:
  - *Scirpus acutus* (hardstem bulrush)                      2 - 6' depth
  - *Scirpus microcarpus* (small-fruited bulrush) 1 - 2.5' depth
  - *Sparganium emersum* (burreed)                                      1 - 2' depth
  - *Sparganium eurycarpum* (burreed)                                      1 - 2' depth
  - *Veronica scutellata*. (marsh speedwell)                                      0 - 1' depth

In addition, the shrub *Spirea douglasii* (Douglas spirea) may be used in combined facilities.

Water Level Fluctuation Restrictions: The difference between the WQ design water surface and the maximum water surface associated with the 2-year runoff shall not be greater than 3 feet. If this restriction cannot be met, the size of the stormwater wetland must be increased. The additional area may be placed in the presettling basin, second cell, or both. If placed in the second cell, the additional area need not be planted with wetland vegetation or counted in calculating the average depth.

Intent: This criterion is designed to dampen the most extreme water level fluctuations expected in combined facilities to better ensure that fluctuation-tolerant wetland plants will be able to survive in the facility. It is not intended to protect native wetland plant communities and is not to be applied to natural wetlands.



# Chapter 7 Conveyance Design

## Chapter Contents

<b>7.1</b>	<b>Introduction.....</b>	<b>303</b>
7.1.1	Purpose and Applicability.....	303
7.1.2	How to use this Chapter.....	303
<b>7.2</b>	<b>Design and Construction Standards .....</b>	<b>303</b>
<b>7.3</b>	<b>Design Storm Frequency.....</b>	<b>304</b>
<b>7.4</b>	<b>Conveyance System Testing.....</b>	<b>304</b>
<b>7.5</b>	<b>Hydraulic Methods.....</b>	<b>305</b>
7.5.1	Closed Conduit Systems.....	305
7.5.1.1	Gravity Flow Analysis .....	305
7.5.1.2	Backwater Analysis .....	306
7.5.1.3	Minimum Pipe Diameter .....	306
7.5.1.4	Allowable Velocities and Slopes .....	307
7.5.1.5	Pipeline Alignments.....	308
7.5.2	Open Conveyances.....	308
7.5.2.1	Allowable Velocities .....	309
7.5.2.2	Side Slopes and Minimum Freeboard.....	310
<b>7.6</b>	<b>Drainage of Highway Pavements.....</b>	<b>310</b>
<b>7.7</b>	<b>Drainage System Outfall Requirements.....</b>	<b>311</b>
7.7.1	Discharges to Surface Water .....	311
7.7.2	Outfalls to Detention Ponds.....	312

## Chapter Figures

Figure 7.1:	Typical Energy Dissipater to Detention Pond or Swale.....	312
-------------	---	-----

## Chapter Tables

Table 7.1:	Manning's "n" Values for Pipes.....	307
Table 7.2:	Maximum Pipe Slopes and Velocities .....	308
Table 7.3:	Open Conveyances Protection.....	310
Table 7.4:	Rock Requirements for Rock Splash Pad Outfalls.....	311

This page intentionally left blank

## 7.1 Introduction

### 7.1.1 Purpose and Applicability

This chapter presents design requirements for open channel and closed conduit stormwater conveyance systems.

Open channel conveyance systems are preferred over closed conduits where feasible, especially where they might provide opportunities for water quality treatment, habitat improvement, or emergency overland flood relief routes.

All new development and redevelopment projects in Clark County are subject to the requirements of this chapter.

### 7.1.2 How to use this Chapter

This chapter includes:

- [Section 7.2](#): Design and Construction Standards
- [Section 7.3](#): Design Storm Frequency
- [Section 7.4](#): Hydraulic Methods
- [Section 7.5](#): Drainage of Highway Pavements
- [Section 7.6](#): Drainage System Outfall Requirements

## 7.2 Design and Construction Standards

The following design standards shall be followed:

- Culverts shall be designed in accordance with the most recent version of the Washington State Department of Transportation *Hydraulics Manual*.
- Fish passage culverts shall meet the design criteria specified in *Water Crossing Design Guidelines* (WDFW, 2013).
- All pipe materials, joints, manholes, and other products associated with conveyance systems shall be designed and constructed in accordance with the 2014 edition of Washington State Department of Transportation *Standard Specifications for Road, Bridge, and Municipal Construction* (WSDOT, 2014).

For computational standards, see [Chapter 1](#).

- No new development, redevelopment, or drainage project shall be allowed to materially increase or concentrate stormwater runoff onto an adjacent property or block existing drainage from adjacent lots.

## 7.3 Design Storm Frequency

The peak runoff rate from the design storms to be used for design of stormwater conveyance systems shall be as follows:

- The 10-year storm: Contributing drainage areas less than 40 acres.
- The 25-year storm: Contributing drainage areas of 40 acres or more.
- The 100-year storm:
  - Culverts with contributing drainage areas greater than 200 acres.
  - Culverts in areas of special flood hazard, as described in FEMA Flood Insurance Rate Maps (FIRM) and reports for Clark County.

The design storm shall be applied to the entire contributing drainage area projected under full build-out conditions.

## 7.4 Conveyance System Testing

All storm sewer pipes shall be cleaned and tested in accordance with WSDOT section 7-04.3(1). Provide County staff with a two working-day notice prior to testing.

All storm sewer lines shall be internally inspected after installation with a tracked, swivel-head television camera. The applicant must provide Clark County with a DVD of the inspection and an inspection record of the entire length of constructed sewer lines. The camera must be stopped at each joint and side sewer and the camera head swiveled to directly view the full circumference of each joint. Each side sewer connection must be similarly inspected. Correct any defects noted during the inspection and re-inspect after the corrections have been completed. The Contractor shall bear all costs for the television inspection and for correcting any found deficiencies.

Storm sewers constructed of thermoplastic pipe shall be tested for deflection not less than 30 days after the trench backfill and compaction has been completed. The test shall be conducted by pulling a properly sized “go-no go” mandrel through the completed pipeline. Testing shall be conducted on a manhole-to-manhole basis and shall be done after the line has been completely flushed out with water.

The mandrel shall be a rigid, nonadjustable mandrel having an effective length of not less than its normal diameter and an odd number of legs (nine legs minimum). Minimum diameter at any point along the full length of the mandrel shall be 95 percent of the base inside diameter of the pipe being tested.

Pipe sections that do not pass the test shall be located and uncovered and correctly reinstalled or replaced. The use of a vibratory re-rounding device or any process other than removal or

reinstallations is not acceptable. The failing sections shall be retested after replacement of the pipe. Pipe large enough to work inside of may be accepted on the basis of direct measurement.

Ground surfaces must be restored to conditions specified in the approved construction plans.

## 7.5 Hydraulic Methods

### 7.5.1 Closed Conduit Systems

Two hydraulic methods can be used for the design of pipelines. The first method is a gravity flow or open channel design, which is most commonly performed using Manning’s equation. This method assumes that flow is steady (does not change with time) and uniform (the depth and velocity remain constant throughout the pipe for a given flow). Manning’s equation can be found in standard hydraulic textbooks and in the WSDOT *Hydraulics Manual*.

The second method is a pressure flow design, where the water surface elevation rises above the crown of the pipe. A backwater analysis is performed to determine the level of the water surface (the hydraulic grade line) for a pipeline system with a given diameter, slope, and flow rate. This method also assumes steady flow, but the flow is not necessarily uniform (the slope of the hydraulic grade line differs from the slope of the pipe).

New pipes shall be designed to operate in an open-channel regime during the design storm and shall be sized using open channel design methods. Under certain hydrologic and hydraulic conditions, however, flow can rise above the pipe, creating a pressurized pipeline. For those situations, it is important to determine the hydraulic grade line to ensure that water does not overtop manholes and catch basins. A backwater analysis shall be calculated under any of the following conditions:

- Pipes with slopes less than 0.50 percent.
- Pipes with velocities over 6.5 feet per second (fps) (for subcritical flow only).
- Inlet and outlet pipes forming a sharp angle (45 degrees or greater) at junctions.
- Pipe inverts less than 3 feet deep when entering and leaving junctions.

#### 7.5.1.1 Gravity Flow Analysis

When using Manning’s equation for the design, each pipe within the system shall be sized and sloped such that its barrel capacity at normal full flow is equal to or greater than the required conveyance capacity for the peak runoff of the design storm. [Table 7.1](#) provides the Manning’s “n” values to be used.

Nomographs may also be used for sizing the pipes. For pipes flowing partially full, the actual velocity can be estimated from engineering nomographs by calculating  $Q_{full}$  and  $V_{full}$  and using the

ratio of  $Q_{\text{design}}/Q_{\text{full}}$  to find  $V$  and  $d$  (the depth of flow). These nomographs can be found in most standard hydraulics manuals or in the WSDOT *Hydraulics Manual*.

### 7.5.1.2 Backwater Analysis

This method uses a rearranged version of Manning's equation expressed in terms of the friction slope. The equation is used to calculate the barrel friction, which is then combined with other friction terms to generate water surface elevations along the length of the pipeline. This method is computationally intensive and is generally performed using computer programs. Detailed information on this method, including procedures for computation by hand, can be found in Section 6.6 of the WSDOT *Hydraulics Manual* (WSDOT 2010) or Section 7 of *Hydraulic Engineering Circular No. 22, Urban Drainage Design Manual (FHWA and NHI 2001)*. Manning's "n" values shall be per [Table 7.1](#).

When conditions require calculation of the hydraulic grade line, the design engineer shall analyze for the design storm event and the 25- and 100-year, 24-hour storm events. For the 25-year event, there shall be a minimum of 1 foot of freeboard between the water surface and the top of any manhole or catch basin.

For the 100-year event, overtopping of the pipe conveyance system may occur; however, the additional flow shall not extend beyond one-half of the lane width of the outside lane of the traveled way and shall not exceed 4 inches in depth at its deepest point. Off-channel storage on private property is allowed with recording of the proper easements. The overtopping flow shall be analyzed by open channel flow methods and added to the flow capacity where it re-enters the pipe system.

### 7.5.1.3 Minimum Pipe Diameter

The minimum pipe diameter shall be 12 inches, except that single laterals less than 50 feet in length may be 8 inches in diameter.

**Table 7.1: Manning's "n" Values for Pipes**

Type of Pipe Material	Backwater Analysis	Manning's Equation
A. Concrete pipe and CPEP-smooth interior pipe	0.012	0.013
B. Annular corrugated metal pipe or pipe arch:		
1. 2-2/3" x 1/2" corrugation (riveted)		
a. plain or fully coated	0.024	0.028
b. paved invert (40% of circumference paved):		
(1) flow full depth	0.018	0.021
(2) flow 0.8 depth	0.016	0.018
(3) flow 0.6 depth	0.013	0.015
c. treatment 5	0.013	0.015
2. 2.3" x 1" corrugation	0.027	0.031
3. 3.6" x 2" corrugation (field bolted)	0.030	0.035
C. Helical 2-2/3" x 1/2" corrugation and CPEP-single wall	0.024	0.028
D. Spiral rib metal pipe and PVC pipe	0.011	0.013
E. Ductile iron pipe cement lined	0.012	0.014
F. High density polyethylene pipe (butt fused only)	0.009	0.009
CPEP = corrugated polyethylene pipe; PVC = polyvinyl chloride.		

#### 7.5.1.4 Allowable Velocities and Slopes

The minimum velocity is 3 feet per second at design flow. This minimum may be waived through the county's Type I or Type II administrative variance process where topography and existing drainage systems make it impractical to meet the standard.

High-density polyethylene (HDPE) pipe systems longer than 100 feet shall be anchored at the upstream end if the slope exceeds 25 percent, and the downstream end shall be placed in a minimum 4-foot long section of the next larger pipe size. This sliding sleeve connection allows for the high thermal expansion/contraction coefficient of the pipe material.

[Table 7.2](#) lists maximum slopes, velocities, and anchor spacings. If velocities exceed 15 feet per second for the conveyance system design event, anchors shall be provided at bends and junctions.

High-density polyethylene (HDPE) pipe systems longer than 100 feet shall be anchored at the upstream end if the slope exceeds 25 percent, and the downstream end shall be placed in a minimum

4-foot long section of the next larger pipe size. This sliding sleeve connection allows for the high thermal expansion/contraction coefficient of the pipe material.

**Table 7.2: Maximum Pipe Slopes and Velocities**

Type of Pipe Material	Pipe Slope above which pipe anchors required	Maximum Slope Allowed	Maximum Velocity Allowed
CMP, Spiral Rib, PVC, CPE	20% (1 anchor per 100 L.F. of pipe)	30%	30 fps
Concrete or smooth-lined CPE	10% (1 anchor per 50 L.F. of pipe)	20%	30 fps
Ductile Iron*	20% (1 anchor per pipe section)	None	None
HDPE**	40% (1 anchor per 100 L.F. of pipe)	None	None
* Flanged joints required. ** Butt-fused joints required.  CPE = corrugated polyethylene; HDPE = high density polyethylene; L.F. = linear feet; fps = feet per second; PVC = polyvinyl chloride			

### 7.5.1.5 Pipeline Alignments

Where a minimal fall is necessary between the inlet and outlet pipes in a structure, pipes shall be aligned vertically by one of the following, in order of preference:

- Match pipe crowns.
- Match 80 percent diameters of pipes.
- Match pipe inverts.

Pipe direction changes or size increases or decreases are allowed only at manholes and catch basins.

Downsizing of pipes is allowed only under the following conditions:

- No hydraulic jump can occur.
- Downstream pipe slope is significantly greater than the upstream slope.
- Velocities remain in the 3 - 8 fps range.

### 7.5.2 Open Conveyances

Where space and topography permit, open conveyances are the preferred means of collecting and conveying stormwater. Public safety must be considered when open conveyances are adjacent to traveled ways and/or accessible to the public.

Open conveyances shall be designed by one of the following methods:



- Manning’s equation (for uniform flow depth, flow velocity, and constant channel cross-section).
- Direct step backwater method (using the energy equation for varying stream channel cross-section).
- Standard step backwater method (using a computer program).

Manning’s equation may be used where uniform flow conditions exist (i.e., the flow depth and velocity remain constant throughout the channel reach). However, if a flow restriction (such as a culvert or bridge) causes flows to rise above normal depth within a channel reach, a backwater analysis shall be performed, using either the direct step or standard step backwater methods.

Direct step methods may be calculated using a spreadsheet or computer program (see the *2005 King County Surface Water Design Manual* for an example). The standard step method is a variation of the direct step method and is commonly performed using a computer program because of the iterative process involved. The most common program using the standard step method is the U.S. Army Corps of Engineers HEC-RAS program.

### 7.5.2.1 Allowable Velocities

Velocities must be low enough to prevent channel erosion, based on the native soil characteristics or the compacted fill material. For velocities above 5 fps, channels shall have an 8-inch- thick rock-lined bottom and side slope to the top of the roadway shoulder or shall be stabilized in a fashion acceptable to Clark County. Water quality shall not be degraded by passage through an open conveyance. [Table 7.3](#) provides specific guidance on channel protection measures.

**Table 7.3: Open Conveyances Protection**

<b>Velocity at Design Flow (fps)</b>	<b>Protection</b>	<b>Thickness</b>	<b>Min. Height Required Above Water Surface</b>
0-5	Grass lining**	N/A	0.5 feet
5-10	Light loose riprap*	1 foot	1.5 feet
10-20	Heavy loose riprap*	2 feet	1.5 feet
20+	Engineered dissipater required	Varies	2.0 feet

\*Riprap shall be in accordance with the most current WSDOT/APWA Standard Specifications.  
 Note: Riprap sizing governed by side slopes on channel, assumed ~3:1.  
 \*\* Bioengineered lining allowed for design flow up to 8 fps.

Channels with a slope of less than 6 percent and peak velocities of less than 5 fps shall be lined with vegetation. Other conveyance protection systems may be allowed if submitted through the appropriate variance process (see CCC 40.386).

### 7.5.2.2 Side Slopes and Minimum Freeboard

Channel side slopes shall not exceed 2:1 for undisturbed ground (cuts) as well as for disturbed ground (embankments). All constructed channels shall be compacted to a minimum 95 percent compaction, as verified by a modified Proctor test (ASTM D1557 / AASHTO T180).

Channels shall be designed with a minimum freeboard of 0.5 feet when the design flow is 10 cfs or less and 1 foot when the design discharge is greater than 10 cfs.

## 7.6 Drainage of Highway Pavements

Drainage design for roadways shall be in accordance with Hydraulic Engineering Circular No. 12, Drainage of Highway Pavements (FHWA 1984), or Hydraulic Engineering Circular No. 22, Urban Drainage Design Manual (FHWA and NHI 2001). Single event storm water models, as described in [Chapter 2](#), shall be used for determining peak flow rates for sizing collection systems (catch basins and inlets).

For the ten (10) year storm, street ponding shall be limited to one-half (1/2) of the roadway area and shall not exceed the capacity of the inlet or produce a flow depth of greater than 0.12 feet at the edge of the travel lane.

For roadway flooding conditions during the one hundred (100) year storm, the equivalent width of one travel lane shall remain open to emergency vehicles at all times. A travel lane will be considered to be open to emergency vehicles if the maximum depth of flow in the lane does not exceed 0.5 feet.

For parking lot flooding conditions during the one hundred (100) year storm, the maximum depth of ponding shall not exceed one and one-half (1.5) feet.

## 7.7 Drainage System Outfall Requirements

### 7.7.1 Discharges to Surface Water

All pipes and culverts that discharge to streams, rivers, ponds, lakes, or other open bodies of water are designated as outfalls. The design and installation of proper energy dissipaters is critical to prevent erosion at or downstream of the point of discharge. Energy dissipater systems include rock splash pads, flow dispersal trenches, and gabion mattresses.

All energy dissipation at outfalls shall be designed for peak flows from a 100-year, 24-hour storm event.

[Table 7.4](#) summarizes the rock requirements for rock splash pad outfalls.

**Table 7.4: Rock Requirements for Rock Splash Pad Outfalls**

<b>Discharge velocity (fps)</b>	<b>Type<sup>1</sup></b>	<b>Thickness</b>	<b>Width</b>	<b>Length</b>	<b>Height</b>
0-5	Quarry spalls	1 foot	Diameter + 6 feet	8 feet or 4 x diameter, whichever is greater	Crown + 1 foot
5-10	Light loose riprap	2 feet	Diameter + 6 feet or 2 x diameter, whichever is greater	12 feet or 4 x diameter, whichever is greater	Crown + 1 foot
10-20	Heavy loose riprap	As required	As required	As required	Crown + 1 foot
20+	Engineered dissipater required				
<i>1. Riprap and quarry spalls shall meet the most current WSDOT specifications for the classes noted.</i>					

Other energy dissipation systems may be allowed if submitted through the appropriate variance process (see CCC 40.386).

Filter fabric or erosion control blankets should always be used under riprap to prevent scour and channel erosion.

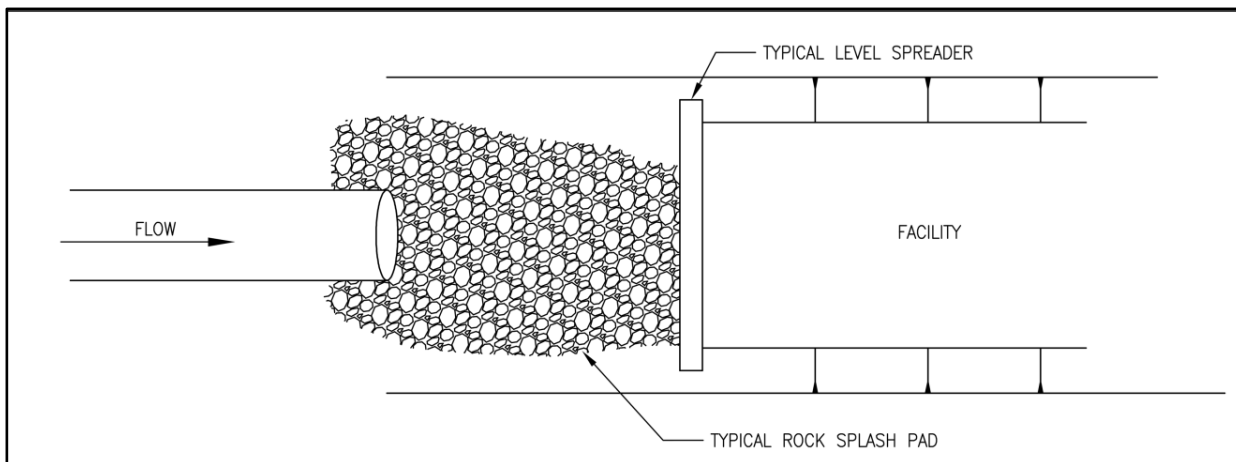
Standard wingwalls, and tapered outlets and paved channels should also be considered when appropriate for permanent culvert outlet protection. (See WSDOT *Hydraulics Manual*, available through WSDOT Engineering Publications.)

Organic or synthetic erosion blankets, with or without vegetation, can also be used. These are often more effective than rock, cheaper, and easier to install. Materials can be chosen using manufacturer product specifications. ASTM test results are available for most products and the designer can choose the correct material for the expected flow.

## 7.7.2 Outfalls to Detention Ponds

Invert elevations for conveyance outfalls into detention ponds shall be set at an elevation where the water surface elevation in the detention pond has a 10% or smaller chance of being equaled or exceeded in any given year. This is determined in WWHM by performing a stage-frequency analysis.

After performing the duration analysis and determining the final detention pond size, go to the “Analysis” section of WWHM, select the “STAGE Mitigated” dataset, and click on “run analysis”. The stage frequency summary is tabulated in the upper right corner. Select the 10 year stage and set the invert elevation of the outfall pipe at or above this elevation.



**Figure 7.1: Typical Energy Dissipater to Detention Pond or Swale**

# Chapter 8 Sediment and Erosion Control BMPs

## Chapter Contents

BMP C101: Preserving Natural Vegetation.....	317
BMP C102: Buffer Zones.....	319
BMP C103: High Visibility Fence.....	320
BMP C105: Stabilized Construction Entrance / Exit.....	321
BMP C106: Wheel Wash.....	325
BMP C107: Construction Road/Parking Area Stabilization .....	327
BMP C120: Temporary and Permanent Seeding .....	329
BMP C121: Mulching .....	334
BMP C122: Nets and Blankets.....	337
BMP C123: Plastic Covering .....	340
BMP C124: Sodding .....	342
BMP C125: Topsoiling / Composting .....	343
BMP C126: Polyacrylamide (PAM) for Soil Erosion Protection.....	347
BMP C130: Surface Roughening.....	351
BMP C131: Gradient Terraces.....	354
BMP C140: Dust Control.....	356
BMP C150: Materials on Hand .....	358
BMP C151: Concrete Handling.....	360
BMP C152: Sawcutting and Surfacing Pollution Prevention.....	362
BMP C153: Material Delivery, Storage and Containment .....	364
BMP C154: Concrete Washout Facilities .....	366
BMP C160: Certified Erosion and Sediment Control Lead (CESCL) .....	373
BMP C162: Construction Sequence Schedule .....	375
BMP C200: Interceptor Dike and Swale .....	376
BMP C201: Grass-Lined Channels.....	379
BMP C202: Channel Lining .....	383
BMP C203: Water Bars.....	385
BMP C204: Pipe Slope Drains .....	387
BMP C205: Subsurface Drains.....	390

<b>BMP C206: Level Spreader .....</b>	<b>393</b>
<b>BMP C207: Check Dams .....</b>	<b>396</b>
<b>BMP C208: Triangular Silt Dike (Geotextile-Encased Check Dam) .....</b>	<b>398</b>
<b>BMP C209: Outlet Protection .....</b>	<b>400</b>
<b>BMP C220: Storm Drain Inlet Protection .....</b>	<b>402</b>
<b>BMP C231: Brush Barrier.....</b>	<b>411</b>
<b>BMP C232: Gravel Filter Berm .....</b>	<b>413</b>
<b>BMP C233: Silt Fence .....</b>	<b>414</b>
<b>BMP C234: Vegetated Strip .....</b>	<b>419</b>
<b>BMP C235: Wattles .....</b>	<b>421</b>
<b>BMP C236: Vegetative Filtration .....</b>	<b>423</b>
<b>BMP C240: Sediment Trap .....</b>	<b>426</b>
<b>BMP C241: Temporary Sediment Pond.....</b>	<b>429</b>
<b>BMP C250: Construction Stormwater Chemical Treatment .....</b>	<b>436</b>
<b>BMP C251: Construction Stormwater Filtration.....</b>	<b>444</b>
<b>BMP C252: High pH Neutralization Using CO<sub>2</sub> (Carbon Dioxide Sparging).....</b>	<b>449</b>
<b>BMP C253: Control of High pH Water.....</b>	<b>452</b>

## Chapter Figures

Figure 8.1: Illustration of Tree's Critical Root Zone .....	318
Figure 8.2: Small-scale Construction Entrance.....	321
Figure 8.3: Construction Entrance Detail .....	322
Figure 8.4: Wheel Wash Detail.....	326
Figure 8.5: Slope Installation - Blankets and Nets .....	338
Figure 8.6: Channel Installation - Blankets and Nets .....	339
Figure 8.7: Surface Roughening by Tracking and Contour Furrows .....	353
Figure 8.8: Gradient Terraces.....	355
Figure 8.9: Concrete Washout Area – Above Grade Options .....	370
Figure 8.10: Concrete Washout Area – Below Grade .....	371
Figure 8.11: Prefabricated Concrete Washout Container with Ramp.....	372
Figure 8.12: Typical Grass-Lined Channels .....	381
Figure 8.13: Temporary Channel Liners .....	382
Figure 8.14: Water Bar.....	386
Figure 8.15: Pipe Slope Drain .....	389
Figure 8.16: Level Spreader Cross-section .....	394
Figure 8.17: Detail of a Level Spreader.....	395

Figure 8.18: Illustration of Storm Drain Inlet Protection.....	402
Figure 8.19: Gravel and Wire Mesh Filter.....	404
Figure 8.20: Silt Sack Detail.....	405
Figure 8.21: Block and Gravel Filter for Drop Inlets.....	407
Figure 8.22: Block and Gravel Curb Inlet Protection .....	408
Figure 8.23: Curb and Gutter Sediment Barrier.....	409
Figure 8.24: Brush Barrier .....	412
Figure 8.25: Silt Fence.....	414
Figure 8.26: Wattles .....	422
Figure 8.27: Manifold and Branches in a wooded, vegetated spray field .....	425
Figure 8.28: Cross-section of Sediment Trap .....	428
Figure 8.29: Sediment Trap Outlet.....	428
Figure 8.30: Sediment Pond Plan View .....	431
Figure 8.31: Temporary Sediment Pond Cross-section .....	431
Figure 8.32: Temporary Sediment Pond Riser Detail.....	432
Figure 8.33: Riser Inflow Curves.....	433

## Chapter Tables

Table 8.1: Temporary Erosion Control Seed.....	330
Table 8.2: Low-Growing Turf Seed Mix .....	330
Table 8.3: Bioswale Seed Mix.....	331
Table 8.4: Wet Area Seed Mix.....	331
Table 8.5: Mulch Standards and Guidelines .....	335
Table 8.6 PAM and Water Application Rates.....	349
Table 8.7: Storm Drain Inlet Protection.....	402
Table 8.8 Geotextile Standards for Silt Fence .....	415
Table 8.9: Contributing Drainage Area for Vegetated Strips .....	419

This page intentionally left blank.



## BMP C101: Preserving Natural Vegetation

---

### Purpose and Description

Preserving vegetation, both native and non-native ground cover, helps reduce erosion generated by a project. Phasing a project to preserve vegetation reduces the need for erosion and sediment controls. In addition, proper preservation of trees and vegetation limit potential for windthrow, preserves the interception of rainfall on the site, and protects root zones that holds the soil in place

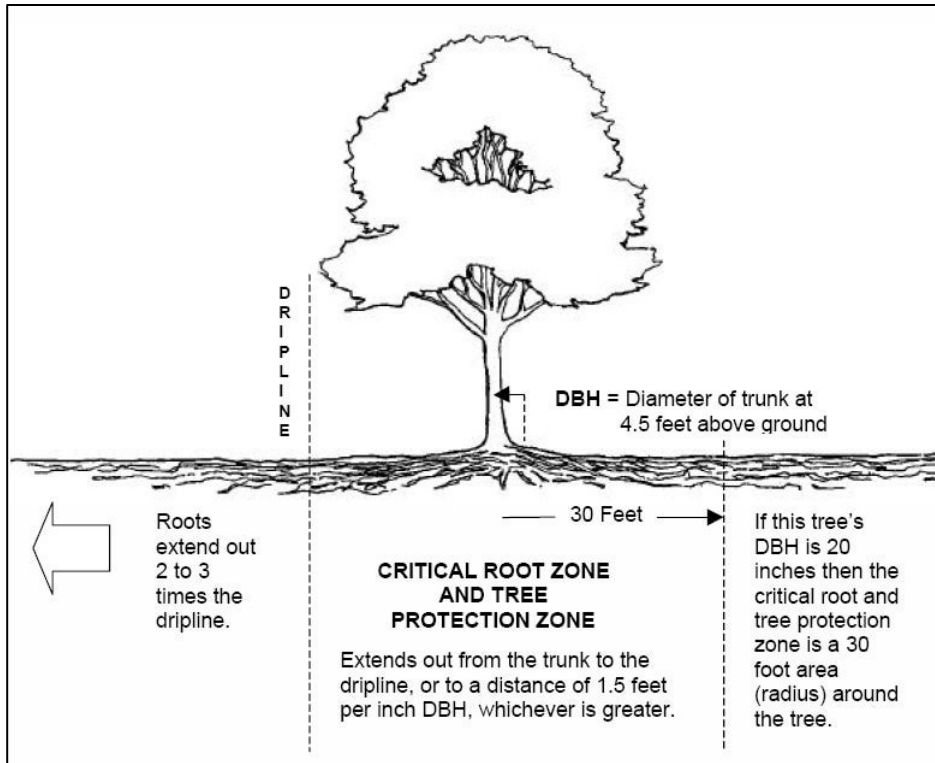
### Conditions of Use

Native vegetation must be preserved to the extent feasible on steep slopes, near perennial and intermittent watercourses or swales, and on building sites in wooded areas.

All projects are subject to Clark County Critical Areas Protection requirements under Title 40 of the Clark County Code (CCC).

### Design Criteria

- Inventory vegetation prior to construction, remove hazard trees and identify vegetation to be saved and protected, document the health and vigor of the vegetation to be protected;
- Identify the critical root zone for vegetation to be protected (within the drip line of the vegetation), place the protective fence just outside the dripline, add colored flagging if necessary to increase visibility of fence;
- No construction activities shall take place within a vegetation's critical root zone, including storage of materials, parking of vehicles or placement of utilities;
- Do not alter the soil grade within the critical root zone of the vegetation; placement of mulch in the critical root zone will help protect the vegetation during construction;
- Avoid cuts to roots within the critical root zone. If the utility trenches are necessary, tunnel under the root and then carefully backfill to original grade as soon as possible.
- Phase construction to preserve natural vegetation on the project site for as long as possible during the construction period.
- Fence or clearly mark areas around native vegetation and existing trees that are designated to be saved. Prevent ground disturbance and compaction at least as far out as the dripline of trees to be saved, if feasible.
- Do not place fill greater than six inches within the dripline of trees to be saved.
- Cut as few tree roots as possible, and cut cleanly when cutting cannot be avoided. Paint cut root ends with a wood dressing like asphalt base paint if roots will be exposed for more than 24-hours.
- Backfill trench near tree roots as soon as possible.



**Figure 8.1: Illustration of Tree's Critical Root Zone**

(Source: Athens/Clark County, Georgia)

See *Stormwater Management Manual for Western Washington (Ecology, 2014) Volume II, pages Res-4 and Res-5* for more information on protecting specific tree species from injuries.

## Maintenance Standards

Inspect flagged and/or fenced areas regularly to make sure flagging or fencing has not been removed or damaged. If the flagging or fencing has been damaged or visibility reduced, repair or replace it immediately and visibility restored.

If tree roots have been exposed or injured, “prune” cleanly with an appropriate pruning saw or loppers directly above the damaged roots and cover with native soils. Treatment of sap flowing trees (fir, hemlock, pine, soft maples) is not advised as sap forms a natural healing barrier.

Inspect protected vegetation at completion of construction. Document and repair any damage to the areas, including the addition of mulch to protect the root zone.

## BMP C102: Buffer Zones

---

### Purpose and Description

Reduce soil erosion and runoff velocities by creating an undisturbed area or strip of natural vegetation or establishing a suitable planting.

### Conditions of Use

Natural buffer zones are used along streams, wetlands and other bodies of water that need protection from erosion and sedimentation. Vegetative buffer zones not designated as critical areas can be used to protect natural swales and can be incorporated into the natural landscaping of an area.

Critical-areas, including wetland buffer zones as described in Title 40, shall remain completely undisturbed and must not be used as sediment treatment areas.

### Design Criteria

- Preserve native vegetation or plantings in clumps, blocks, or strips where feasible.
- Leave all unstable steep slopes along watercourses in existing vegetation.
- Mark clearing limits with high-visibility fence, and keep all equipment and construction debris out of the critical habitat areas, natural areas to be preserved, and wetland buffer zones.
- Keep all excavations outside the dripline of trees and shrubs.
- Do not push debris or extra soil into the buffer zone area.

### Maintenance Standards

Inspect the area frequently to make sure fencing remains in place and the area remains undisturbed.

## BMP CI03: High Visibility Fence

---

### Purpose and Description

Fencing is intended to:

1. Restrict clearing to approved limits.
2. Prevent disturbance of sensitive areas, their buffers, and other areas required to be left undisturbed.
3. Limit construction traffic to designated construction entrances, exits, or internal roads.
4. Protect areas where marking with survey tape may not provide adequate protection.

### Conditions of Use

Use whenever necessary to establish clearing limits and to exclude construction equipment from and prevent clearing of sensitive areas, their buffers, and other areas to be left uncleared.

### Design Criteria

High visibility plastic fence shall be composed of a high-density polyethylene material and shall be at least four feet in height. Posts for the fencing shall be steel or wood and placed every 6 feet on center (maximum) or as needed to ensure rigidity. The fencing shall be fastened to the post every six inches with a polyethylene tie. On long continuous lengths of fencing, a tension wire or rope shall be used as a top stringer to prevent sagging between posts. The fence color shall be high visibility orange. The fence tensile strength shall be 360 lbs./ft. using the ASTM D4595 testing method.

If appropriate install fabric silt fence in accordance with [BMP C233](#) to act as high visibility fence. Silt fence shall be at least 3 feet high and must be highly visible to meet the requirements of this BMP.

Metal fences shall be designed and installed according to the manufacturer's specifications. Metal fences shall be at least 3 feet high and must be highly visible.

Fences shall not be wired or stapled to trees.

### Maintenance Standards

If the fence has been damaged or visibility reduced, it shall be repaired or replaced immediately and visibility restored.

## BMP C105: Stabilized Construction Entrance / Exit

---

### Purpose and Description

Stabilized Construction entrances are established to reduce the amount of sediment transported onto paved roads by vehicles or equipment.

### Conditions of Use

Construction entrances must be stabilized wherever traffic will be entering or leaving a construction site if paved roads or other paved areas are within 1,000 feet of the site.

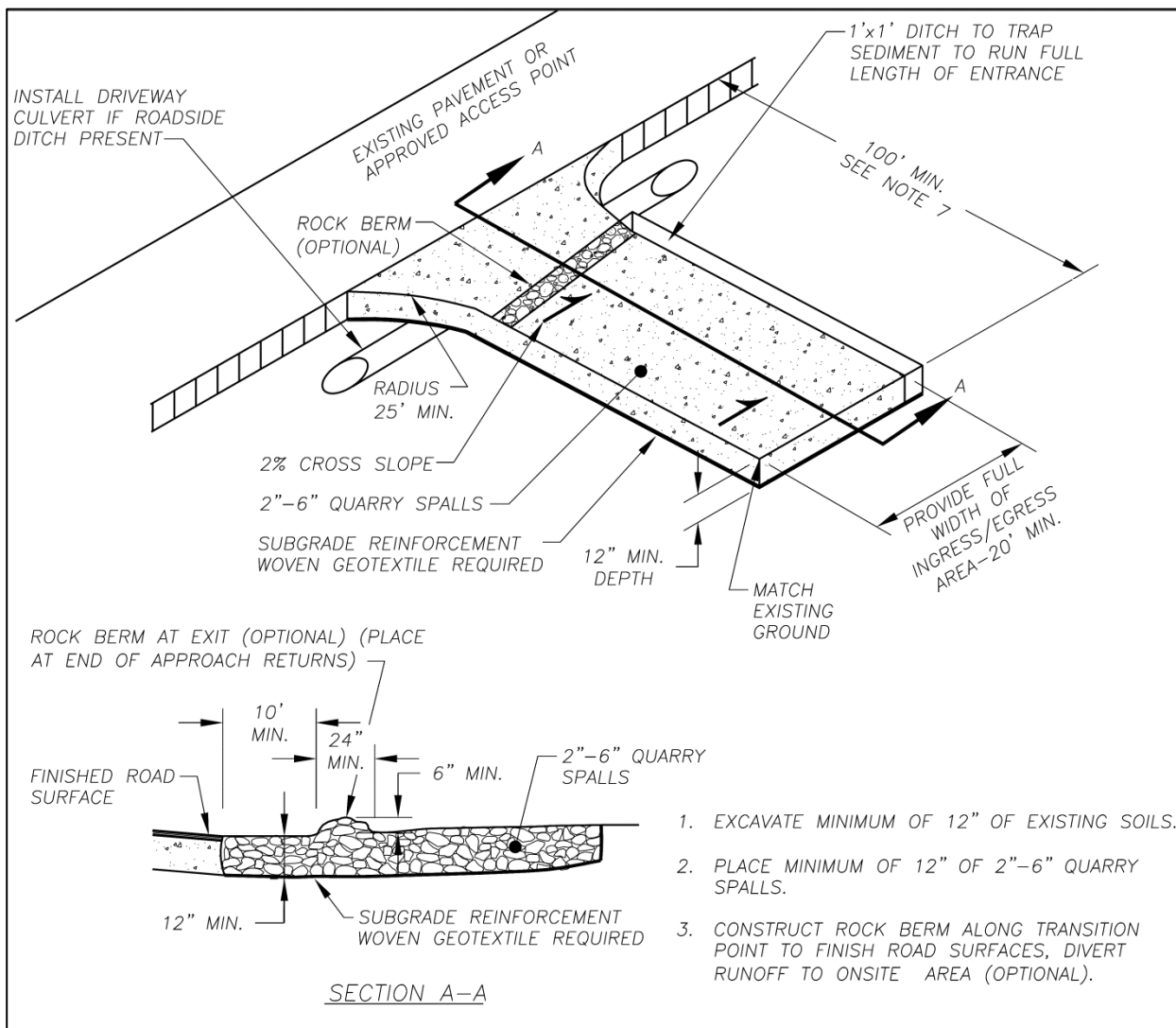
For residential construction, provide stabilized construction entrances for each building site under construction in addition to at the main subdivision entrance. Stabilized surfaces shall be of sufficient length/width to provide vehicle access/parking, based on lot size/configuration.

This BMP has products approved as equivalent by Ecology. See [Book 1, Section 6.5.1](#).



**Figure 8.2: Small-scale Construction Entrance**

## Design Criteria



**Figure 8.3: Construction Entrance Detail**

(Source: Clark County)

Construct a stabilized pad of quarry spalls at entrances and exits for construction sites.

Note: the 100' minimum length of the entrance shall be reduced to the maximum practicable size when the size or configuration of the site does not allow the full length.

Construct stabilized construction entrances with a 12-inch thick pad of 4-inch to 8-inch quarry spalls, a 4-inch course of asphalt treated base (ATB), or use existing pavement. Do not use crushed concrete, cement, or calcium chloride.

A separation geotextile shall be placed under the spalls to prevent fine sediment from pumping up into the rock pad. The geotextile shall meet the following standards:

<b>Grab Tensile Strength (ASTM D4751)</b>	200 psi min.
<b>Grab Tensile Elongation (ASTM D4632)</b>	30% max.
<b>Mullen Burst Strength (ASTM D3786-80a)</b>	400 psi min.
<b>AOS (ASTM D4751)</b>	20-45 (U.S. standard sieve size)

Fencing (see [BMP C103](#)) shall be installed as necessary to restrict traffic to the construction entrance.

Whenever possible, the entrance shall be constructed on a firm, compacted subgrade. This can substantially increase the effectiveness of the pad and reduce the need for maintenance.

Construction entrances should avoid crossing existing sidewalks and back of walk drains if at all possible. If a construction entrance must cross a sidewalk or back of walk drain, the full length of the sidewalk and back of walk drain must be covered and protected from sediment leaving the site.

### Maintenance Standards

Quarry spalls shall be added if the pad is no longer in accordance with the specifications.

- If the entrance is not preventing sediment from being tracked onto pavement, then alternative measures to keep the streets free of sediment shall be used. This may include replacement/cleaning of the existing quarry spalls, street sweeping, an increase in the dimensions of the entrance, or the installation of a wheel wash ([BMP C106](#)).
- Any sediment that is tracked onto pavement shall be removed by shoveling or street sweeping. The sediment collected by sweeping shall be removed or stabilized on site. The pavement shall not be cleaned by washing down the street, except when high efficiency sweeping is ineffective and there is a threat to public safety. If it is necessary to wash the streets, the construction of a small sump to contain the wash water shall be considered. The sediment would then be washed into the sump where it can be controlled.
- Perform street sweeping by hand or with a high efficiency sweeper. Do not use a non-high efficiency mechanical sweeper because this creates dust and throws soils into storm systems or conveyance ditches.
- Remove any quarry spalls that end up on the roadway immediately.
- If vehicles are entering or exiting the site at points other than the construction entrance(s), fencing (see [BMP C103](#)) shall be installed to control traffic.

- Upon project completion and site stabilization, all construction accesses intended as permanent access for maintenance shall be permanently stabilized.



## BMP C106: Wheel Wash

---

### Purpose and Description

A wheel wash is a paved or fabricated structure containing water through which vehicles are driven. It reduces the amount of sediment transported onto paved roads by motor vehicles.

### Conditions of Use

Use a wheel wash when a stabilized construction entrance ([BMP C105](#)) is not preventing sediment from being tracked onto pavement.

- Wheel washing is generally an effective BMP when installed with careful attention to topography. For example, a wheel wash can be detrimental if installed at the top of a slope abutting a right-of-way where the water from the dripping truck can run unimpeded into the street.
- Pressure washing combined with an adequately sized and surfaced pad with direct drainage to a large 10-foot x 10-foot sump can be very effective.
- Discharge wheel wash or tire bath wastewater to a separate on-site treatment system that prevents discharge to surface water, such as closed-loop recirculation or upland land application, or to the sanitary sewer with local sewer district approval.
- Wheel wash or tire bath wastewater should not include wastewater from concrete washout areas.

### Design Criteria

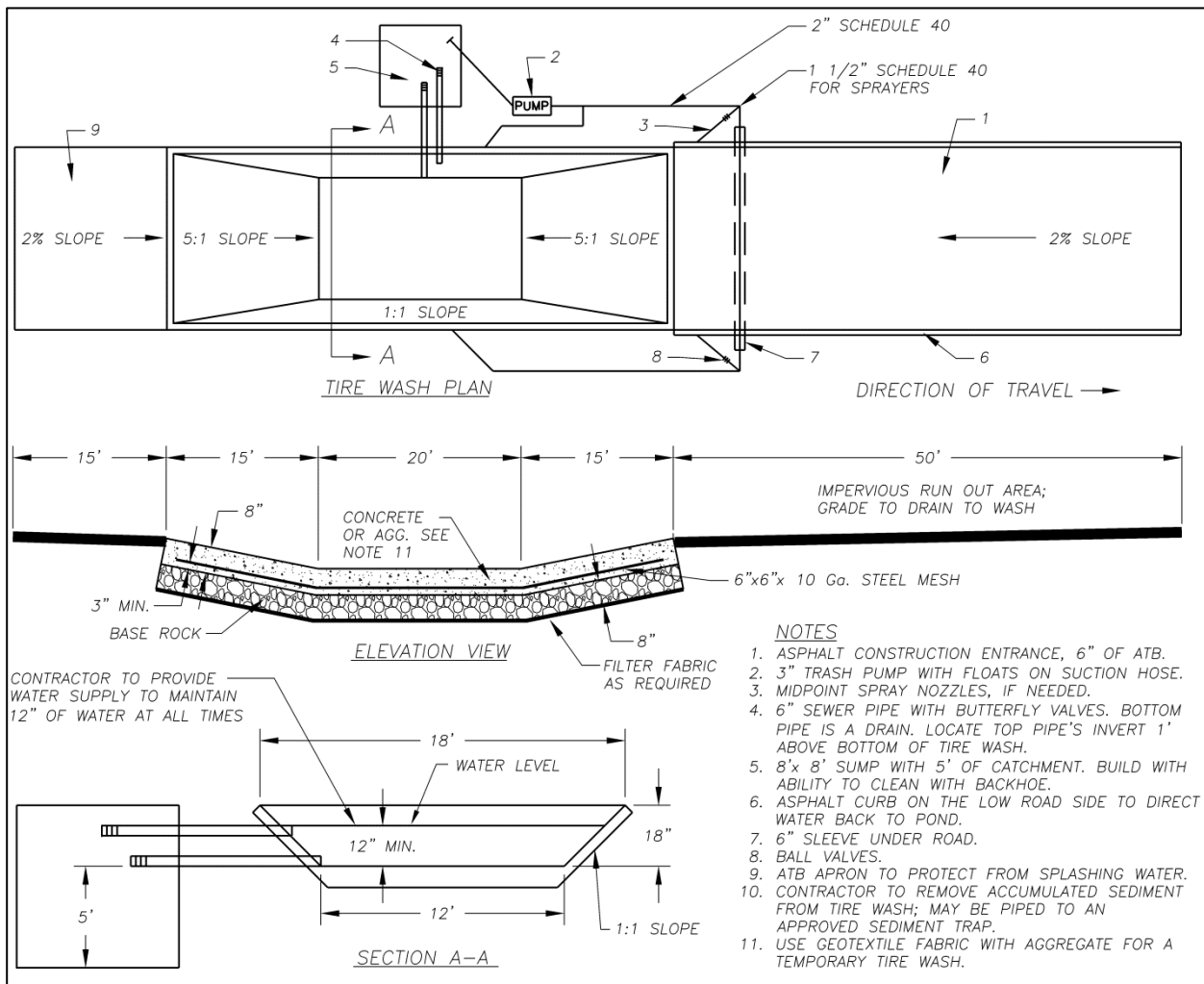
- Suggested details are shown in [Figure 8.4](#). The Responsible Official may allow other designs.
- Pavement should be a minimum of 6 inches of asphalt treated base (ATB) over crushed base material or 8 inches over compacted subgrade.
- Before paving, use a low clearance truck to test clearance of the wheel wash.
- Maintain the water level from 12 to 14 inches deep.
- Install midpoint spray nozzles if the wheel wash alone is not effective at preventing sediment transport off the site.
- Design the wash with a small grade change, 6- to 1-inches for a 10-foot-wide pond, to allow sediment to flow to the low side of pond to help prevent re-suspension of sediment.
- Install a drainpipe with a 2- to 3-foot riser on the low side of the pond to allow for cleaning and refilling.
- Polymers may be used to promote coagulation and flocculation in a closed-loop system. Polyacrylamide (PAM) may be added to the wheel wash water at a rate of 0.25 - 0.5 pounds per 1,000 gallons of water.

- Commercial temporary wheel wash systems are available and may be used if they meet the design specifications.

## Maintenance Standards

Replace wheel wash water at the start of each working day. During each working day, replace wheel wash water again at least once, or more often on large earthwork jobs where more than 10-20 trucks per hour leave the site.

Water removed from the wheel wash must be properly disposed of. The preferred disposal option is discharge to a sanitary sewer at an approved location. Other disposal options include discharge back into a pretreatment facility on the site. See [Appendix 3-E](#) in [Book 3](#) for additional guidance.



**Figure 8.4: Wheel Wash Detail**

(Source: Clark County)

## BMP C107: Construction Road/Parking Area Stabilization

---

### Purpose and Description

Stabilizing subdivision roads, parking areas, and other on-site vehicle transportation routes immediately after grading reduces erosion caused by construction traffic or runoff.

### Conditions of Use

Roads or parking areas shall be stabilized wherever they are constructed, whether permanent or temporary, for use by construction traffic.

High Visibility Fencing (see [BMP C103](#)) shall be installed, if necessary, to limit the access of vehicles to only those roads and parking areas that are stabilized.

### Design Criteria

- On areas that will receive asphalt as part of the project, install the first lift as soon as possible.
- Apply 6 inches of 2- to 4-inch crushed rock, gravel base, or crushed surfacing base course immediately after grading or utility installation. A 4-inch course of asphalt treated base (ATB) may also be used, or the road/parking area may be paved. If cement or cement kiln dust is used for roadbase stabilization, pH monitoring and BMPs (BMPs [C252](#) and [C253](#)) are required to evaluate and minimize the effects on stormwater. If the area will not be used for permanent roads, parking areas, or structures, a 6-inch depth of hog fuel may also be used. Whenever possible, construction roads and parking areas shall be placed on a firm, compacted subgrade.
- Temporary road gradients shall not exceed 15 percent. Roadways shall be carefully graded to drain.
  - If runoff is concentrated, then do either 1 or 2, and also do 3 below:
    - p. Provide drainage ditches on each side of the roadway in the case of a crowned section
    - q. Provide a drainage ditch on one side of the roadway in the case of a super-elevated section.
    - r. Direct drainage ditches to a sediment control BMP.
  - If the road is graded so that runoff sheetflows, then direct flow into a Vegetated Strip ([BMP C234](#)).
- Protect storm drain inlets to prevent sediment-laden water entering the storm drain system (see [BMP C220](#)).

## Maintenance Standards

- Inspect stabilized areas regularly, especially after large storm events.
- Add crushed rock, gravel base, etc. as required to maintain a stable driving surface and to stabilize any areas that have eroded.
- If areas are paved, perform street cleaning at the end of each day or more often if necessary.
- Following construction, restore these areas to pre-construction condition or better to prevent future erosion.

## BMP C120: Temporary and Permanent Seeding

---

### Purpose and Description

Seeding reduces erosion by stabilizing exposed soils with vegetative cover. A well-established vegetative cover is one of the most effective methods of reducing erosion.

### Conditions of Use

Use seeding throughout the project on disturbed areas that have reached final grade or that will remain unworked for more than 30 days.

This BMP has products approved as equivalent by Ecology. See [Book 1, Section 6.5.1](#).

### Design Criteria

#### Timing

Between July 1 and August 30 seeding requires irrigation until 75 percent grass cover is established.

Between October 1 and March 30 seeding requires a cover of mulch with straw or an erosion control blanket until 75 percent grass cover is established.

Review all disturbed areas in late August to early September and complete all seeding by the end of September.

Seed and mulch all disturbed areas not otherwise vegetated at final site stabilization. Final stabilization means the completion of all soil disturbing activities at the site and the establishment of a permanent vegetative cover, or equivalent permanent stabilization measures (such as pavement, riprap, gabions or geotextiles) which will prevent erosion.

#### Seed

The seed mixes listed in the tables below include recommended mixes for both temporary and permanent seeding in various conditions.

Apply seed mixes in accordance with the supplier's recommended application rate for each seed mix.

Other mixes may be appropriate depending on site conditions. The Responsible Official may approve alternative seed mixes recommended in writing for the project site by the Clark Conservation District.

**Table 8.1: Temporary Erosion Control Seed**

	<b>% Weight</b>
Annual rye grass <i>Lolium multiflorum</i>	100

**Table 8.2: Low-Growing Turf Seed Mix**

	<b>% Weight</b>	<b>% Purity</b>	<b>% Germination</b>
Dwarf tall fescue (several varieties) <i>Festuca arundinacea var.</i>	45	98	90
Dwarf perennial rye (Barclay) <i>Lolium perenne var. barclay</i>	30	98	90
Red fescue <i>Festuca rubra</i>	20	98	90
Colonial bentgrass <i>Agrostis tenuis</i>	5	98	90
<b>Add One of the Following to Mix:</b>	<b>Lbs per Acre</b>		
Poco barley <i>Hordeum vulgare var Poco</i>	50		
Regreen wheat x wheatgrass hybrid <i>Triticum aestivum x Elytrigia elongata</i>	50		

Use the low-growing turf seed mix in dry situations where there is no need for watering.

**Table 8.3: Bioswale Seed Mix**

<p><b>Bioswale Seed Mix</b> See <a href="#">Table 4.7</a>.</p>
--

Use the bioswale seed mix for bioswales and other intermittently wet areas.

**Table 8.4: Wet Area Seed Mix**

	<b>% Weight</b>	<b>% Purity</b>	<b>% Germination</b>
Tall or meadow fescue <i>Festuca arundinacea</i> or <i>Festuca elatior</i>	60-70	98	90
Seaside/Creeping bentgrass <i>Agrostis palustris</i>	10-15	98	85
Meadow foxtail <i>Alepocurus pratensis</i>	10-15	90	80
Alsike clover <i>Trifolium hybridum</i>	1-6	98	90
Redtop bentgrass <i>Agrostis alba</i>	1-6	92	85
<b>Add One of the Following to Mix:</b>	<b>Lbs per Acre</b>		
Poco barley <i>Hordeum vulgare</i> var <i>Poco</i>	50		
Regreen wheat x wheatgrass hybrid <i>Triticum aestivum</i> x <i>Elytrigia elongata</i>	50		

Use the wet area seed mix for very wet areas that are not regulated wetlands. Apply wet area seed mix in accordance with the supplier’s recommended application rate for each seed mix.

Seeding should take place in September or very early October in order to obtain adequate establishment prior to the winter months.

**Hydroseeding**

- Hydroseed applications shall include a minimum of 1,500 pounds per acre of mulch with 3 percent tackifier. See [BMP C121: Mulching](#) for specifications.

- Re-install topsoil on the disturbed soil surface before application. Areas that will have seeding only and not landscaping may need compost or meal-based mulch included in the hydroseed in order to establish vegetation.

## Hand-Seeding

Seed may be installed by hand in only the following circumstances:

- For establishing temporary vegetation
  - Cover by straw, mulch, or topsoil
- For establishing permanent vegetation in areas less than 1 acre
  - Cover with mulch, topsoil, or erosion blankets

## Mulch

Use of mulch for seeding is required. Mulch may be applied on top of the seed or simultaneously by hydroseeding. See [BMP C121: Mulching](#) for specifications.

## Seeding Vegetated Channels

Install channels intended for vegetation before starting major earthwork and hydroseed with a Bonded Fiber Matrix. For vegetated channels that will have high flows, install erosion control blankets over hydroseed. Before allowing water to flow in vegetated channels, establish 75 percent vegetation cover. If vegetated channels cannot be established by seed before water flow; install sod in the channel bottom—over hydromulch and erosion control blankets.

Confirm the installation of all required surface water control measures to prevent seed from washing away.

## Roughening and Rototilling

The seedbed should be firm and rough. Roughen all soil no matter what the slope.

If engineering purposes require compaction, then track walk slopes before seeding. Do not backblade or smooth slopes greater than 4H:1V if they are to be seeded.

Restoration-based landscape practices require deeper incorporation than that provided by a simple single-pass rototilling treatment. Wherever practical, initially rip the subgrade to improve long-term permeability, infiltration, and water inflow qualities. At a minimum, permanent areas shall use soil amendments to achieve organic matter and permeability performance defined in engineered soil/landscape systems. For systems that are deeper than 8 inches complete the rototilling process in multiple lifts, or prepare the engineered soil system per specifications and place to achieve the specified depth.



## Fertilizer

Soil tests are recommended to determine the most effective fertilizer mix and application rate. Based on the results, add appropriate level of fertilizer, such as a slow release 10-4-6 (N-P-K) fertilizer.

Use a slow-release 10-4-6 N-P-K (nitrogen-phosphorus-potassium) fertilizer at a rate of 90 pounds per acre. For hydroseeding applications, do not add fertilizer to the hydromulch machine, or agitate, more than 20 minutes before use to prevent destruction of the slow-release coating.

The Responsible Official may authorize the use of other products that take the place of chemical fertilizers, such as products containing seaweed extracts, or mulches containing 100% cottonseed meal.

## Bonded Fiber Matrix and Mechanically Bonded Fiber Matrix

On steep slopes use Bonded Fiber Matrix (BFM) or Mechanically Bonded Fiber Matrix (MBFM) products. Apply BFM/MBFM products at a minimum rate of 3,000 pounds per acre of mulch with approximately 10 percent tackifier. Achieve a minimum of 95 percent soil coverage during application. Install products per manufacturer's instructions. Most products require 24-36 hours to cure before rainfall and cannot be installed on wet or saturated soils. Generally, products come in 40-50 pound bags and include all necessary ingredients except for seed and fertilizer.

## Maintenance Standards

For areas that receive sheet or concentrated flows, reseed any area that fails to establish 100 percent cover. For other areas, reseed areas that fail to establish at least 80 percent cover. Reseed and protect by mulch any areas that experience erosion after establishment.

If reseeding is ineffective, use an alternate method such as sodding ([BMP C124](#)), mulching ([BMP C121](#)), or nets/blankets ([BMP C122](#)). If winter weather prevents adequate grass growth, the Responsible Official may relax the time limitation when sensitive areas would otherwise be protected.

Supply seeded areas with adequate moisture, but do not water to the extent that it causes runoff or erosion.

## BMP CI21: Mulching

---

### Purpose and Description

Mulching soils provides immediate temporary protection from erosion. Mulch also enhances plant establishment by conserving moisture, holding fertilizer, seed, and topsoil in place, and moderating soil temperatures. This section discusses the most common types of mulch, although many more are available.

### Conditions of Use

As a temporary cover measure, mulch should be used:

- For less than 30 days on disturbed areas that require cover.
- At all times on seeded areas.
- During the wet season on slopes steeper than 3H:1V with more than 10 feet of vertical relief.

Mulch may be applied at any time of the year and must be refreshed periodically.

### Design Criteria

For mulch materials, application rates, and specifications, see [Table 8.5](#).

Where the option of “Compost” is selected, it should be a coarse compost that meets the following size gradations when tested in accordance with the U.S. Composting Council “Test Methods for the Examination of Compost and Composting” (TMECC) Test Method 02.02-B.

#### Coarse Compost

- Minimum Percent passing 3” sieve openings 100%
- Minimum Percent passing 1” sieve openings 90%
- Minimum Percent passing  $\frac{3}{4}$ ” sieve openings 70%

Minimum Percent passing  $\frac{1}{4}$ ” sieve openings 40% For seeded areas mulch may be made up of 100 percent: cottonseed meal; fibers made of wood, recycled cellulose, hemp, kenaf; compost; or blends of these.

Tackifier, if used, shall be plant-based, such as guar or alpha plantago, or chemical-based such as polyacrylamide or polymers.

Apply mulch to a thickness of 2 inches or sufficient thickness so that the ground is not visible under the mulch layer, whichever is greater. The Responsible Official may require increased thickness on disturbed areas in or near sensitive areas or other areas highly susceptible to erosion.

Mulch used within the ordinary high-water mark of surface waters should be selected to minimize potential flotation of organic matter. Composted organic materials have higher specific gravities (densities) than straw, wood, or chipped material.

### Maintenance Standards

- The thickness of the cover must be maintained.
- Any areas that experience erosion shall be remulched and/or protected with a net or blanket. If the erosion problem is drainage related, then the problem shall be fixed and the eroded area remulched.

**Table 8.5: Mulch Standards and Guidelines**

<b>Mulch Material</b>	<b>Quality Standards</b>	<b>Application Rates*</b>	<b>Remarks</b>
Straw	Straw mulch shall meet quality standards established in WSDOT Standard Specifications, 9-14.4(1).	2"-3" thick; 5 bales per 1,000 sf or 2-3 tons per acre	Cost-effective protection when applied with adequate thickness. Hand-application generally requires greater thickness than blown straw. The thickness of straw may be reduced by half when used in conjunction with seeding. In windy areas straw must be held in place by crimping, using a tackifier, or covering with netting. Blown straw always has to be held in place with a tackifier as even light winds will blow it away. Straw, however, has several deficiencies that should be considered when selecting mulch materials. It often introduces and/or encourages the propagation of weed species and it has no significant long-term benefits. It should also not be used within the ordinary high-water elevation of surface waters (due to flotation).
Hydromulch	No growth inhibiting factors.	Approx. 25-30 lbs per 1,000 sf or 1,500 - 2,000 lbs per acre	Shall be applied with hydromulcher. Shall not be used without seed and tackifier unless the application rate is at least doubled. Fibers longer than about ¾-1 inch clog hydromulch equipment. Fibers should be kept to less than ¾ inch.
Compost	No visible water or dust during handling. Must be produced in accordance with <a href="#">WAC 173-350</a> , Solid Waste Handling Standards, but may have up to 35% biosolids .	2" thick min.; approx. 100 tons per acre (approx. 800 lbs per yard)	More effective control can be obtained by increasing thickness to 3". Excellent mulch for protecting final grades until landscaping because it can be directly seeded or tilled into soil as an amendment. Compost used for mulch has a coarser size gradation than compost used for BMP C125 or BMP T5.13. It is more stable and practical to use in wet areas and during rainy weather conditions. Do not use near wetlands or near phosphorous impaired water bodies.
Table continues on next page			

<b>Mulch Material</b>	<b>Quality Standards</b>	<b>Application Rates*</b>	<b>Remarks</b>
Chipped Site Vegetation	Average size shall be several inches. Gradations from fines to 6 inches in length for texture, variation, and interlocking properties.	2" thick min.;	This is a cost-effective way to dispose of debris from clearing and grubbing, and it eliminates the problems associated with burning. Generally, it should not be used on slopes above approx. 10% because of its tendency to be transported by runoff. It is not recommended within 200 feet of surface waters. If seeding is expected shortly after mulch, the decomposition of the chipped vegetation may tie up nutrients important to grass establishment.
Wood-based Mulch or Wood Straw	No visible water or dust during handling. Must be purchased from a supplier with a Solid Waste Handling Permit or one exempt from solid waste regulations.	2" thick min.; approx. 100 tons per acre (approx. 800 lbs. per cubic yard)	This material is often called "hog or hogged fuel." The use of mulch ultimately improves the organic matter in the soil. Special caution is advised regarding the source and composition of wood-based mulches. Its preparation typically does not provide any weed seed control, so evidence of residual vegetation in its composition or known inclusion of weed plants or seeds should be monitored and prevented (or minimized).
Wood Strand Mulch	A blend of loose, long, thin wood pieces derived from native conifer or deciduous trees with high length-to-width ratio.	2" thick min.	Cost-effective protection when applied with adequate thickness. A minimum of 95-percent of the wood strand shall have lengths between 2 and 10-inches, with a width and thickness between 1/16 and 3/8-inches. The mulch shall not contain resin, tannin, or other compounds in quantities that would be detrimental to plant life. Sawdust or wood shavings shall not be used as mulch. (WSDOT specification (9-14.4(4)))
* Application rates in the table are minimums. Apply mulch to a thickness of 2 inches or sufficient thickness so that the ground is not visible under the mulch layer, whichever is greater. The Responsible Official may require increased thickness on disturbed areas in or near sensitive areas or other areas highly susceptible to erosion.			

## BMP C122: Nets and Blankets

---

### Purpose and Description

Erosion control nets and blankets are intended to prevent erosion and hold seed and mulch in place on steep slopes and in channels so that vegetation can become well established. The application of appropriate netting or blanket to drainage ditches and swales can protect bare soil from channelized runoff while vegetation is established. Nets and blankets also can capture a great deal of sediment due to their open, porous structure. In addition, some nets and blankets can be used to permanently reinforce turf to protect drainage ways during high flows. Nets (commonly called matting) are strands of material woven into an open, but high-tensile strength net. Blankets are strands of material that are loosely woven and form a layer of interlocking fibers, typically held together by a biodegradable or photodegradable netting. They generally have lower tensile strength than nets, but cover the ground more completely. Coir (coconut fiber) fabric comes as both nets and blankets.

### Conditions of Use

Erosion control nets and blankets should be used:

- To aid permanent vegetated stabilization of slopes 2H:1V or greater and with more than 10 feet of vertical relief.
- To protect bare soil from channelized runoff while vegetation is established in drainage ditches and swales (highly recommended). Nets and blankets may be used to permanently stabilize channels and may provide a cost-effective, environmentally preferable alternative to riprap.

### Design Criteria

- See [Figure 8.5](#) and [Figure 8.6](#) for typical orientation and installation of blankets used in channels and as slope protection. Note: these are typical only; install all blankets per the manufacturer's instructions.
- The blanket or net must maintain ground contact along the entire surface.
- Install mulch ([BMP C121](#)) with most nets (e.g. jute matting). Excelsior, woven straw blankets and coir (coconut fiber) blankets may be installed without mulch.
- Use synthetic blankets on extremely steep, unstable, wet, or rocky slopes and on riverbanks, beaches and other high-energy environments. Hydromulch the soil before installing a synthetic blanket.

### Installation of Blankets on Slopes

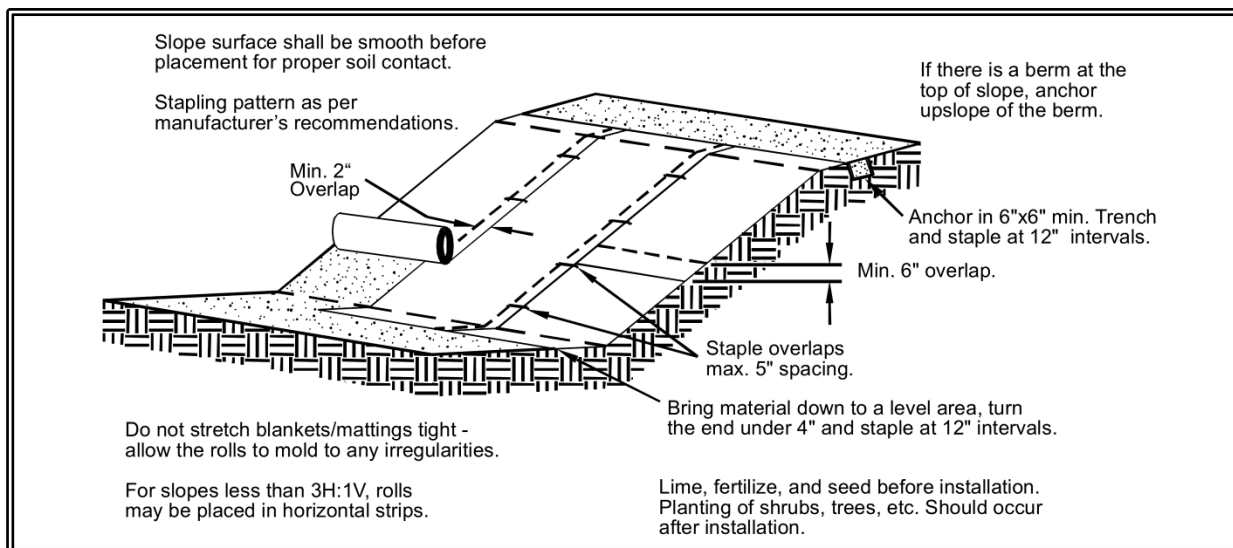
Follow the Design Criteria above and these additional instructions. Install products per manufacturer's specifications. General instructions are:

1. Complete final grade and track walk up and down the slope.

2. Install hydromulch with seed and fertilizer.
3. Dig a small trench, approximately 12 inches wide by 6 inches deep along the top of the slope.
4. Install the leading edge of the blanket into the small trench and staple or stake approximately every 18 inches.
5. Roll the blanket slowly down the slope as installer walks backwards and install staples per manufacturer's instructions as product is unrolled. Do not allow the blanket to roll down the slope on its own. Do not walk on the blanket after it is in place.
6. If the blanket is not long enough to cover the entire slope length, the trailing edge of the upper blanket should overlap the leading edge of the lower blanket and be stapled. On steeper slopes, this overlap should be installed in a small trench, stapled, and covered with soil.

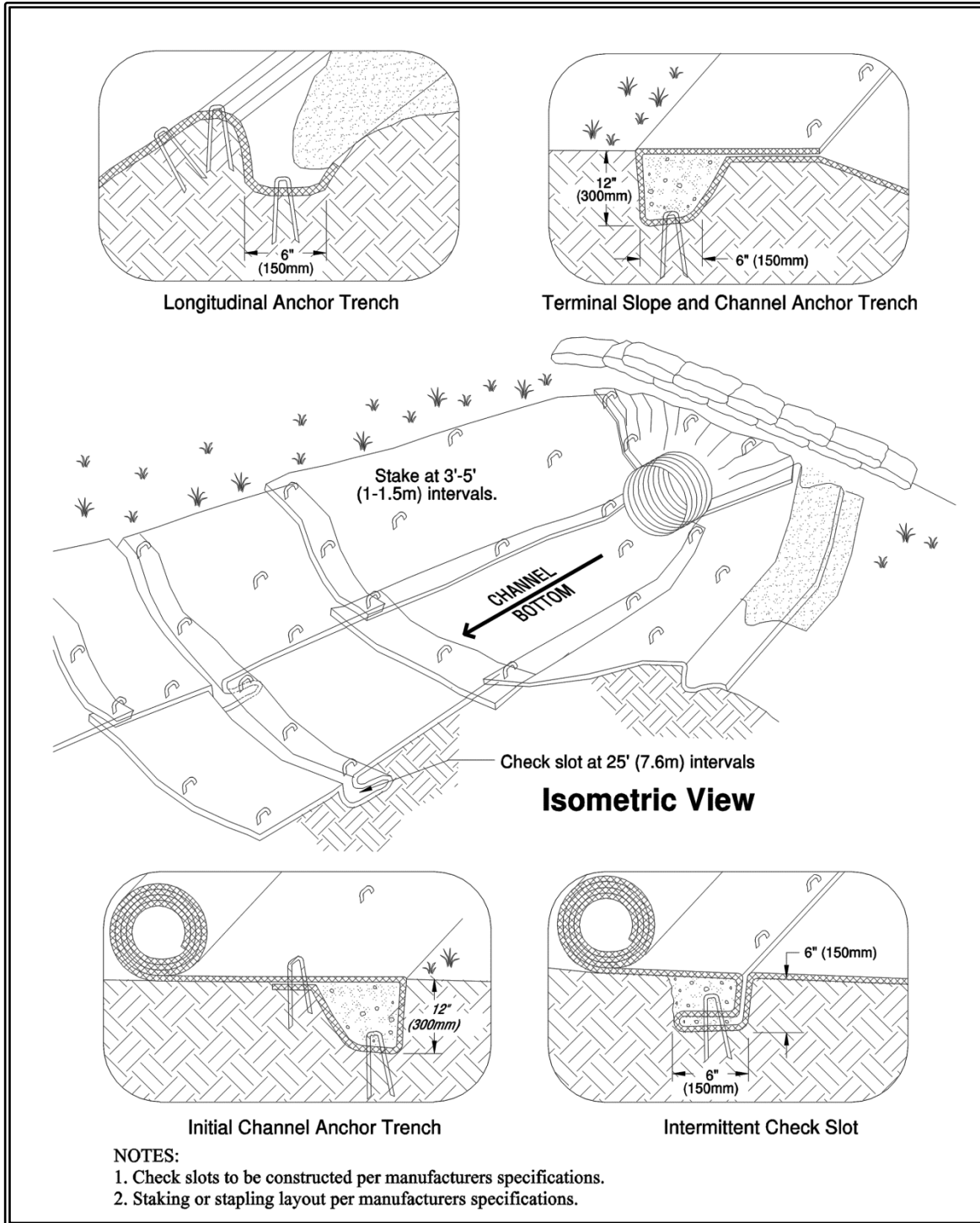
## Maintenance Standards

- Repair and staple any areas of the net or blanket that are damaged or not in close contact with the ground.
- If erosion occurs as a result of poorly controlled drainage, fix the problem and protect the eroded areas.



**Figure 8.5: Slope Installation - Blankets and Nets**

(Source: SMMWW)



**Figure 8.6: Channel Installation - Blankets and Nets**

(Source: WA State Dept. of Ecology)

## BMP CI23: Plastic Covering

---

### Purpose and Description

Plastic covering provides immediate, short-term erosion protection to slopes and disturbed areas.

### Conditions of Use

Plastic covering may be used on disturbed areas that require cover measures for less than 30 days, except as stated below.

Plastic is particularly useful for protecting cut and fill slopes and stockpiles. Note: The relatively rapid breakdown of most polyethylene sheeting makes it unsuitable for long-term (greater than six months) applications.

- Due to rapid runoff caused by plastic covering, do not use this method upslope of areas that might be adversely impacted by concentrated runoff. Such areas include steep and/or unstable slopes.
- Plastic sheeting may result in increased runoff volumes and velocities, requiring additional on-site measures to counteract the increases. Creating a trough with wattles or other material can convey clean water away from these areas.
- To prevent undercutting, trench and backfill rolled plastic covering products.
- While plastic is inexpensive to purchase, the added cost of installation, maintenance, removal, and disposal make this an expensive material, up to \$1.50-2.00 per square yard.
- Whenever plastic is used to protect slopes install water collection measures at the base of the slope. These measures include plastic-covered berms, channels, and pipes used to convey clean rainwater away from bare soil and disturbed areas. Do not mix clean runoff from a plastic covered slope with dirty runoff from a project.
- Other uses for plastic include:
  1. Temporary ditch liner.
  2. Pond liner in temporary sediment pond.
  3. Liner for bermed temporary fuel storage area if plastic is not reactive to the type of fuel being stored.
  4. Emergency slope protection during heavy rains.
  5. Temporary drainpipe (“elephant trunk”) used to direct water.

This BMP has products approved as equivalent by Ecology. See [Book 1, Section 6.5.1](#).



## Design Criteria

Plastic slope cover must be installed as follows:

1. Run plastic up and down slope, not across slope.
  2. Plastic may be installed perpendicular to a slope if the slope length is less than 10 feet.
  3. Minimum of 8-inch overlap at seams.
  4. On long or wide slopes, or slopes subject to wind, tape all seams.
  5. Place plastic into a small (12-inch wide by 6-inch deep) slot trench at the top of the slope and backfill with soil to keep water from flowing underneath.
  6. Place sand filled burlap or geotextile bags every 3 to 6 feet along seams and tie them together with twine to hold them in place.
  7. Inspect plastic for rips, tears, and open seams regularly and repair immediately. This prevents high velocity runoff from contacting bare soil which causes extreme erosion.
  8. Sandbags may be lowered into place tied to ropes. However, all sandbags must be staked in place.
- Plastic sheeting shall have a minimum thickness of 0.06 millimeters.
  - If erosion at the toe of a slope is likely, a gravel berm, riprap, or other suitable protection shall be installed at the toe of the slope in order to reduce the velocity of runoff.

## Maintenance Standards

- Torn sheets must be replaced and open seams repaired.
- Completely remove and replace the plastic if it begins to deteriorate due to ultraviolet radiation.
- Completely remove plastic when no longer needed.

## BMP CI24: Sodding

---

### Purpose and Description

The purpose of sodding is to establish permanent turf for immediate erosion protection and to stabilize drainage ways where concentrated overland flow will occur.

### Conditions of Use

Sodding may be used in the following areas:

- Disturbed areas that require short-term or long-term cover.
- Disturbed areas that require immediate vegetative cover.
- All drainageways that require vegetative lining.

### Design Criteria

Sod shall be free of weeds, of uniform thickness (approximately 1-inch thick), and shall have a dense root mat for mechanical strength.

The following steps are recommended for sod installation:

- Shape and smooth the surface to final grade in accordance with the approved grading plan. over-excavated 4 to 6 inches below design elevation to allow room for soil amendments and sod.
- Amend 4 inches (minimum) of compost into the top 8 inches of the soil if the organic content of the soil is less than ten percent or the permeability is less than 0.6 inches per hour.
- Fertilize according to the supplier's recommendations. Work lime and fertilizer 1 to 2 inches into the soil, and smooth the surface.
- Lay strips of sod beginning at the lowest area to be sodded and perpendicular to the direction of water flow. Wedge strips securely into place. Square the ends of each strip to provide for a close, tight fit. Stagger joints at least 12 inches. Staple on slopes steeper than 3H:1V. Staple the upstream edge of each sod strip.
- Roll the sodded area and irrigate.
- When sodding is carried out in alternating strips or other patterns, seed the areas between the sod immediately after sodding.

### Maintenance Standards

If the grass is unhealthy, determine the cause and take appropriate action to reestablish a healthy groundcover. If necessary, remove the sod and install a different BMP.

## BMP C125: Topsoiling / Composting

---

*Note: To meet Minimum Requirement #5, use [BMP T5.13](#), Post-Construction Soil Quality and Depth, in Book 2 of this manual.*

### Purpose

Topsoiling and composting provide a suitable growth medium for final site stabilization with vegetation. While not a permanent cover practice in itself, topsoiling and composting are an integral component of providing permanent cover in those areas where there is an unsuitable soil surface for plant growth. Use this BMP in conjunction with other BMPs such as seeding, mulching, or sodding.

Note that this BMP is functionally equivalent to [BMP T5.13](#), Post-Construction Soil Quality and Depth, which is required for all disturbed areas that will be developed as lawn or landscaped areas at the completed project site.

Native soils and disturbed soils that have been organically amended not only retain much more stormwater, but they also serve as effective biofilters for urban pollutants and, by supporting more vigorous plant growth, reduce the water, fertilizer and pesticides needed to support installed landscapes. Topsoil does not include any subsoils but only the material from the top several inches including organic debris.

This BMP also includes standards for managing soil stock piles on site.

### Conditions of Use

- Permanent landscaped areas shall contain healthy topsoil that reduces the need for fertilizers, improves overall topsoil quality, provides for better vegetal health and vitality, improves hydrologic characteristics, and reduces the need for irrigation.
- Leave native soils and the duff layer undisturbed to the maximum extent practicable. Do not strip existing, properly functioning soil system and vegetation if the only purpose is topsoiling later.
- Areas that already have good topsoil, such as undisturbed areas, do not require soil amendments.
- Restore, to the maximum extent practical, native soils disturbed during clearing and grading to a condition equal to or better than the original site condition's moisture-holding capacity. Use on-site native topsoil, incorporate amendments into on-site soil, or import blended topsoil.
- When topsoiling is required when establishing vegetation on shallow soils, and soils of critically low pH (high acid) levels.

## Design Criteria

Meet the following requirements for disturbed areas that will be developed as lawn or landscaped areas at the completed project site:

- Maximize the depth of the topsoil wherever possible to provide the maximum possible infiltration capacity and beneficial growth medium. Topsoil shall have:
  - A minimum depth of 8-inches. Scarify subsoils below the topsoil layer at least 4-inches with some incorporation of the upper material to avoid stratified layers, where feasible. Ripping or re-structuring the subgrade may also provide additional benefits regarding the overall infiltration and interflow dynamics of the soil system.
  - A minimum organic content of 10% dry weight in planting beds and 5% organic matter content in turf areas. Incorporate organic amendments to a minimum 8-inch depth except where tree roots or other natural features limit the depth of incorporation.
  - A pH between 6.0 and 8.0 or matching the pH of the undisturbed soil.
  - If blended topsoil is imported, then fines should be limited to 25 percent passing through a 200 sieve.
  - Mulch planting beds with 2 inches of organic material.
- Accomplish the required organic content, depth, and pH by returning native topsoil to the site, importing topsoil of sufficient organic content, and/or incorporating organic amendments.
  - When using the option of incorporating amendments to meet the organic content requirement, use compost that meets the compost specifications for Bioretention (see [BMP T5.14B](#)), with the exception that the compost may have up to 35% biosolids or manure.
  - Sections three through seven of the document entitled, Guidelines and Resources for Implementing Soil Quality and Depth [BMP T5.13](#) in WDOE Stormwater Management Manual for Western Washington, provides useful guidance for implementing whichever option is chosen. It includes guidance for pre-approved default strategies and guidance for custom strategies. It is available through the organization Soils for Salmon. As of this printing the document may be found at: [http://www.soilsforsalmon.org/pdf/Soil BMP Manual.pdf](http://www.soilsforsalmon.org/pdf/Soil_BMP_Manual.pdf).

Select composition and construction of the soil system based on plant species desired to cover the area. For example, incorporation of topsoil may favor grasses, while layering with mildly acidic, high-carbon amendments may favor more woody vegetation.

- Allow sufficient time in scheduling for topsoil spreading prior to seeding, sodding, or planting.
- Take care when applying top soil to subsoils with contrasting textures. Sandy topsoil over clayey subsoil is a particularly poor combination, as water creeps along the junction between the soil layers and causes the topsoil to slough. If topsoil and subsoil are not properly bonded, water will

not infiltrate the soil profile evenly and it will be difficult to establish vegetation. The best method to prevent a lack of bonding is to actually work the topsoil into the layer below for a depth of at least 6 inches.

*See 2014 Stormwater Management Manual for Western Washington, Volume II, page 4-31 for advice on topsoil selection and installation.*

- Field exploration of the site shall be made to determine if there is surface soil of sufficient quantity and quality to justify stripping. Topsoil shall be friable and loamy (loam, sandy loam, silt loam, sandy clay loam, and clay loam). Avoid areas of natural groundwater recharge.
- Stripping shall be confined to the immediate construction area. A 4-inch to 6-inch stripping depth is common, but depth may vary depending on the particular soil. All surface runoff control structures shall be in place prior to stripping.
- Do not place topsoil while in a frozen or muddy condition, when the subgrade is excessively wet, or when conditions exist that may otherwise be detrimental to proper grading or proposed sodding or seeding.
- In areas requiring grading, remove and stockpile the duff layer and topsoil on site in a designated, controlled area, not adjacent to public resources and critical areas. Stockpiled topsoil is to be reapplied to other portions of the site where feasible. Stockpiling of topsoil shall occur in the following manner:
  - Side slopes of the stockpile shall not exceed 2H:1V.
  - Between October 1 and April 30:
    - An interceptor dike with gravel outlet and silt fence shall surround all topsoil.
    - Within 2 days either complete erosion control seeding, or cover stockpiles with clear plastic or mulch.
  - Between May 1 and September 30:
    - An interceptor dike with gravel outlet and silt fence shall surround all topsoil if the stockpile will remain in place for a longer period of time than active construction grading.
    - Within 7 days, either complete erosion control seeding, or cover stockpiles with mulch.
- Retain or restore mycorrhizal bacteria, earthworms, and other beneficial organisms.
  - When using off-site topsoil, use commercially available mycorrhiza products.
  - When using native topsoil stockpiled from the site, ensure that the beneficial organisms will not be destroyed by:
    - s. Re-install topsoil within 4 to 6 weeks.

- t. Do not allow the saturation of topsoil with water.
- u. Do not use plastic covering.

## Maintenance Standards

- Inspect stockpiles regularly, especially after large storm events. Stabilize any areas that have eroded using any BMP appropriate to address Element #5 in [Book 1, section 6.4.5](#).
- Establish soil quality and depth toward the end of construction and once established, protect from compaction, such as from large machinery use, and from erosion. (Also see [BMP T5.13, Post-Construction Soil Quality and Depth in Chapter 8](#).)
- Plant and mulch soil after installation.
- Leave plant debris or its equivalent on the soil surface to replenish organic matter.
- Reduce and adjust, where possible, the use of irrigation, fertilizers, herbicides and pesticides, rather than continuing to implement formerly established practices.

## BMP C126: Polyacrylamide (PAM) for Soil Erosion Protection

---

### Purpose and Description

Polyacrylamide (PAM) is used on construction sites to prevent soil erosion.

Applying PAM to bare soil in advance of a rain event significantly reduces erosion and controls sediment in two ways. First, PAM increases the soil's available pore volume, thus increasing infiltration through flocculation and reducing the quantity of stormwater runoff. Second, it increases flocculation of suspended particles and aids in their deposition, thus reducing stormwater runoff turbidity and improving water quality.

Loss of sediment and PAM to surface waters or a municipal storm sewer may be a basis for penalties per RCW 90.48.080 and Clark County Code.

### Conditions of Use

PAM shall not be directly applied to water or allowed to enter a water body.

In areas that drain to a sediment pond, PAM can be applied to bare soil under the following conditions:

- During rough grading operations.
- In staging areas.
- Balanced cut and fill earthwork.
- Haul roads prior to placement of crushed rock surfacing.
- Compacted soil roadbase.
- Stockpiles.
- After final grade and before paving or final seeding and planting.
- Pit sites.
- Sites having a winter shut down. In the case of winter shut down, or where soil will remain unworked for several months, PAM should be used together with mulch.

### Design Criteria

- PAM may be applied with water in dissolved form. The preferred application method is the dissolved form.
- Proper application and re-application plans are necessary to ensure total effectiveness of PAM usage.
- The specific PAM copolymer formulation must be anionic. **Cationic PAM shall not be used in any application because of known aquatic toxicity problems.** Only the highest drinking

water grade PAM, certified for compliance with ANSI/NSF Standard 60 for drinking water treatment, will be used for soil applications. Recent media attention and high interest in PAM has resulted in some entrepreneurial exploitation of the term "polymer." All PAM are polymers, but not all polymers are PAM, and not all PAM products comply with ANSI/NSF Standard 60. PAM use shall be reviewed and approved by the Responsible Official and the Department of Ecology.

- PAM designated for these uses should be "water soluble" or "linear" or "non-crosslinked". Cross-linked or water absorbent PAM, polymerized in highly acidic (pH<2) conditions, are used to maintain soil moisture content.
- The PAM anionic charge density may vary from 2-30 percent; a value of 18 percent is typical. Studies conducted by the United States Department of Agriculture (USDA)/ARS demonstrated that soil stabilization was optimized by using very high molecular weight (12-15 mg/mole), highly anionic (>20% hydrolysis) PAM.
- PAM tackifiers, if used, should be used at a rate of no more than 0.5-1 lb. per 1000 gallons of water in a hydromulch machine.

## Safety

PAM, combined with water, is very slippery and can be a safety hazard. Care must be taken to prevent spills of PAM powder onto paved surfaces. During an application of PAM, prevent overspray from reaching pavement as pavement will become slippery. If PAM powder gets on skin or clothing, wipe it off with a rough towel rather than washing with water-this only makes cleanup messier and take longer.

## The Preferred Method – Dissolved Application

PAM is to be applied at a maximum rate of 2/3 pound PAM per 1,000 gallons water (80 mg/L) per 1 acre of bare soil. [Table 8.6](#) can be used to determine the PAM and water application rate for a disturbed soil area. Higher concentrations of PAM **do not** provide any additional effectiveness.

- Pre-measure the area where PAM is to be applied and calculate the amount of product and water necessary to provide coverage at the specified application rate (2/3 pound PAM/1000 gallons/acre).
- PAM has infinite solubility in water, but dissolves very slowly. Dissolve pre-measured dry granular PAM with a known quantity of clean water in a bucket several hours or overnight. Mechanical mixing will help dissolve the PAM. Always add PAM to water - not water to PAM.
- Pre-fill the water truck about 1/8 full with water. The water does not have to be potable, but it must have relatively low turbidity – in the range of 20 NTU or less.
- Add PAM /Water mixture to the truck
- Completely fill the water truck to specified volume.



- Spray PAM/Water mixture onto dry soil until the soil surface is uniformly and completely wetted.

**Table 8.6 PAM and Water Application Rates**

<b>PAM and Water Application Rates</b>		
<b>Disturbed Area (ac)</b>	<b>PAM (lbs)</b>	<b>Water (gal)</b>
0.50	0.33	500
1.00	0.66	1,000
1.50	1.00	1,500
2.00	1.32	2,000
2.50	1.65	2,500
3.00	2.00	3,000
3.50	2.33	3,500
4.00	2.65	4,000
4.50	3.00	4,500
5.00	3.33	5,000

### **An Alternate Method – Dry Application**

PAM may also be applied as a powder at the rate of 5 lbs. per acre. This must be applied on a day that is dry. For areas less than 5-10 acres, a hand-held “organ grinder” fertilizer spreader set to the smallest setting will work. Tractor-mounted spreaders will work for larger areas.

The following shall be used for application of powdered PAM:

- Powdered PAM shall be used in conjunction with other BMPs and not in place of other BMPs.
- Do not use PAM on a slope that flows directly into a stream or wetland. The stormwater runoff shall pass through a sediment control BMP prior to discharging to surface waters.
- Do not add PAM to water discharging from site.
- When the total drainage area is greater than or equal to 5 acres, PAM treated areas shall drain to a sediment pond.
- Areas less than 5 acres shall drain to sediment control BMPs, such as a minimum of 3 check dams per acre. The total number of check dams used shall be maximized to achieve the greatest

amount of settlement of sediment prior to discharging from the site. Each check dam shall be spaced evenly in the drainage channel through which stormwater flows are discharged off-site.

- On all sites, the use of silt fence shall be maximized to limit the discharges of sediment from the site.
- All areas not being actively worked shall be covered and protected from rainfall. PAM shall not be the only cover BMP used.
- PAM can be applied to wet soil, but dry soil is preferred due to less sediment loss.
- PAM will work when applied to saturated soil but is not as effective as applications to dry or damp soil.
- Keep the granular PAM supply out of the sun. Granular PAM loses its effectiveness in three months after exposure to sunlight and air.

### **Maintenance Standards**

- PAM may be reapplied on actively worked areas after a 48-hour period.
- Reapplication is not required unless PAM treated soil is disturbed or unless turbidity levels show the need for an additional application. If PAM treated soil is left undisturbed a reapplication may be necessary after two months. More PAM applications may be required for steep slopes, silty and clayey soils (USDA Classification Type "C" and "D" soils), long grades, and high precipitation areas. When PAM is applied first to bare soil and then covered with straw, a reapplication may not be necessary for several months.

## BMP C130: Surface Roughening

---

### Purpose and Description

Surface roughening aids in the establishment of vegetative cover, reduces runoff velocity, increases infiltration, and provides for sediment trapping. Horizontal depressions are created by operating a tiller or other suitable equipment on the contour or by leaving slopes in a roughened condition by not fine grading them.

Use this BMP in conjunction with other BMPs such as seeding, mulching, or sodding.

### Conditions for Use

- Slopes steeper than 3H:1V and greater than 5 vertical feet require surface roughening to a depth of 2 to 4 inches prior to seeding.
- Areas that will not be stabilized immediately may be roughened to reduce runoff velocity until seeding takes place.
- Slopes with a stable rock face do not require roughening.
- Slopes where mowing is planned should not be excessively roughened (see specifications below).

### Design Criteria

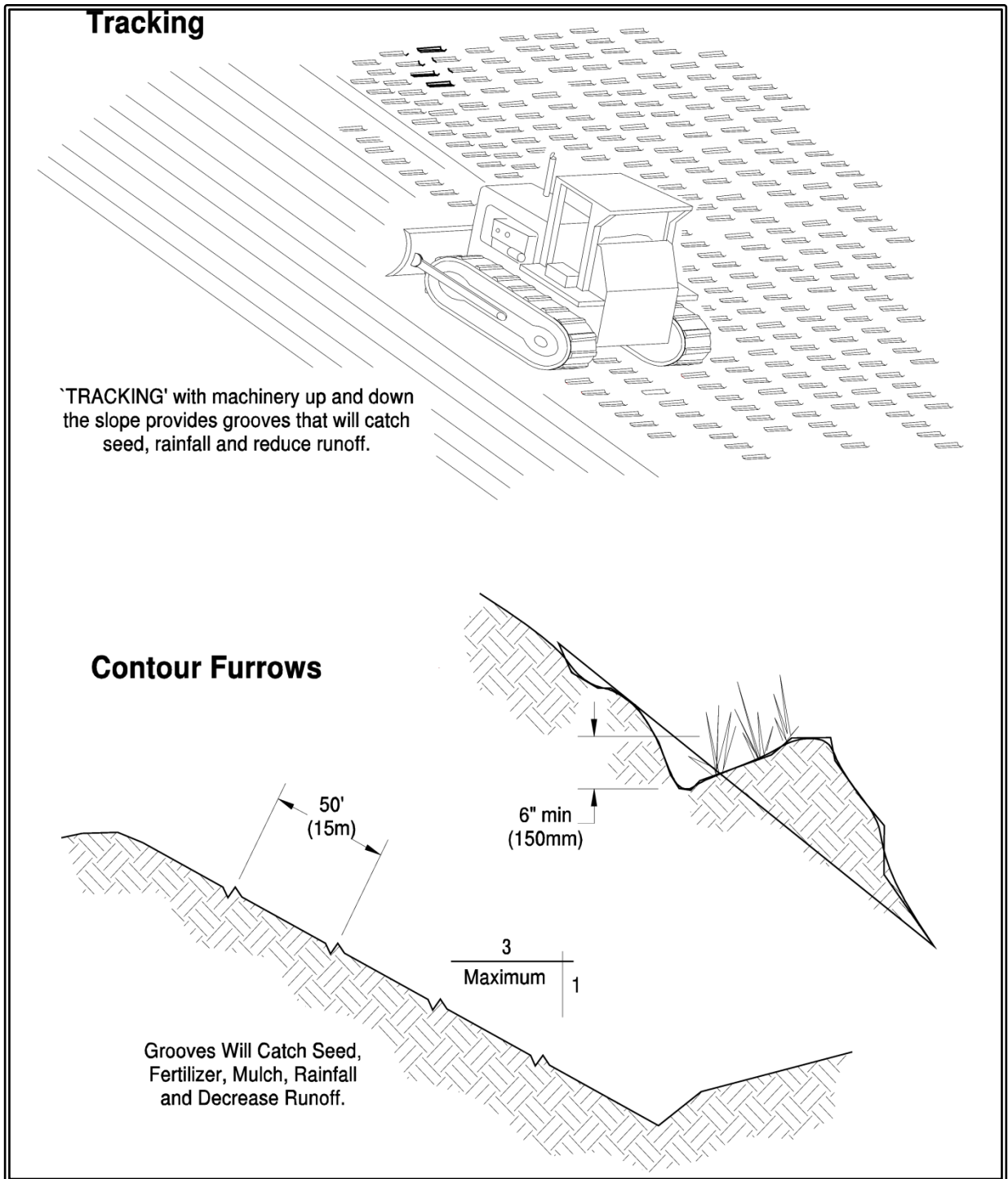
There are different methods for achieving a roughened soil surface on a slope, and the selection of an appropriate method depends upon the type of slope. Roughening methods include stair-step grading, grooving, contour furrows, and tracking. See [Figure 8.7](#) for tracking and contour furrows. Factors to be considered in choosing a method are slope steepness, mowing requirements, and whether the slope is formed by cutting or filling.

- Disturbed areas that will not require mowing may be stair-step graded, grooved, or left rough after filling.
- Stair-step grading is particularly appropriate in soils containing large amounts of soft rock. Each "step" catches material that sloughs from above, and provides a level site where vegetation can become established. Stairs should be wide enough to work with standard earth moving equipment. Stair steps must be on contour or gullies will form on the slope.
- Areas that will be mowed (these areas should have slopes less steep than 3H:1V) may have small furrows left by disking, harrowing, raking, or seed-planting machinery operated on the contour.
- Graded areas with slopes steeper than 3H:1V but less than 2H:1V should be roughened before seeding. This can be accomplished in a variety of ways, including "track walking," or driving a crawler tractor up and down the slope, leaving a pattern of cleat imprints parallel to slope contours.

- Tracking is done by operating equipment up and down the slope to leave horizontal depressions in the soil.

## **Maintenance Standards**

- Areas that are roughened should be seeded as quickly as possible.
- Regular inspections should be made of the area. If rills appear, they should be re-graded and re-seeded immediately.



**Figure 8.7: Surface Roughening by Tracking and Contour Furrows**

(Source: WA State Dept. of Ecology)

## BMP CI31: Gradient Terraces

---

### Purpose and Description

Gradient terraces reduce erosion damage by intercepting surface runoff and conducting it to a stable outlet at a non-erosive velocity.

### Conditions of Use

Gradient terraces normally are limited to denuded land having a water erosion problem. They should not be constructed on deep sands or on soils that are too stony, steep, or shallow to permit practical and economical installation and maintenance. Gradient terraces may be used only where suitable outlets are or will be made available. See [Figure 8.8](#) for gradient terraces.

### Design Criteria

- The maximum vertical spacing of gradient terraces should be determined by the following method:

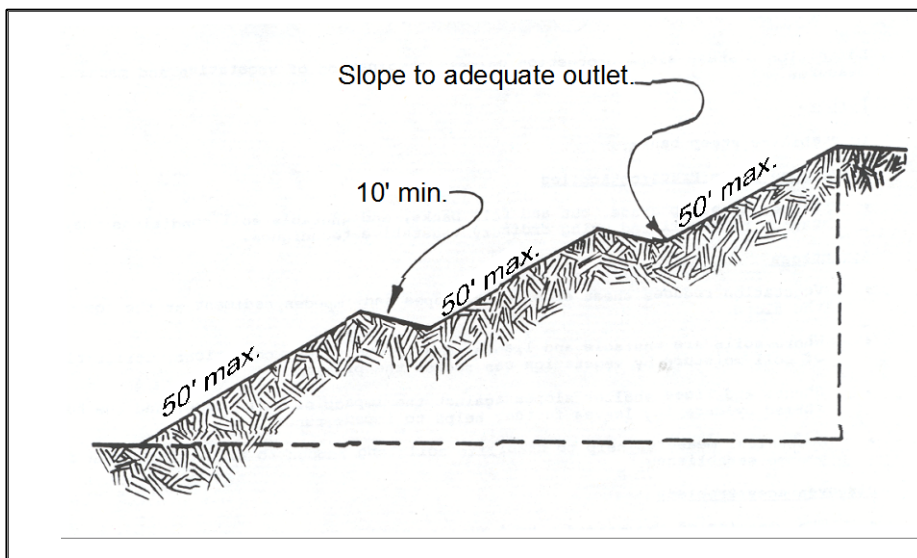
$$VI = (0.8)s + y$$

Where:	VI	=	vertical interval in feet
	s	=	land rise per 100 feet, expressed in feet
	y	=	a soil and cover variable with values from 1.0 to 4.0

Values of “y” are influenced by soil erodibility and cover practices. The lower values are applicable to erosive soils where little to no residue is left on the surface. The higher value is applicable only to erosion-resistant soils where a large amount of residue (1½ tons of straw/acre equivalent) is on the surface.

- The minimum constructed cross-section should meet the design dimensions.
- The top of the constructed ridge should not be lower at any point than the design elevation plus the specified overfill for settlement. The opening at the outlet end of the terrace should have a cross-section equal to that specified for the terrace channel.
- Channel grades may be either uniform or variable with a maximum grade of 0.6 feet per 100 feet length (0.6%). For short distances, terrace grades may be increased to improve alignment. The channel velocity should not exceed that which is non-erosive for the soil type.
- All gradient terraces should have adequate outlets. Such an outlet may be a grassed waterway, vegetated area, or tile outlet. In all cases the outlet must convey runoff from the terrace or terrace system to a point where the outflow will not cause damage. Vegetative cover should be used in the outlet channel.

- The design elevation of the water surface of the terrace should not be lower than the design elevation of the water surface in the outlet at their junction, when both are operating at design flow.
- Vertical spacing determined by the above methods may be increased as much as 0.5 feet or 10 percent, whichever is greater, to provide better alignment or location, to avoid obstacles, to adjust for equipment size, or to reach a satisfactory outlet. The drainage area above the terrace should not exceed the area that would be drained by a terrace with normal spacing.
- The terrace should have enough capacity to handle the peak runoff expected from a 2-year, 24-hour design storm without overtopping.
- The terrace cross-section should be proportioned to fit the land slope. The ridge height should include a reasonable settlement factor. The ridge should have a minimum top width of 3 feet at the design height. The minimum cross-sectional area of the terrace channel should be 8 square feet for land slopes of 5 percent or less, 7 square feet for slopes from 5 to 8 percent, and 6 square feet for slopes steeper than 8 percent. The terrace can be constructed wide enough to be maintained using a small vehicle.



**Figure 8.8: Gradient Terraces**

(Source: WA Department of Ecology)

### Maintenance Standards

- Maintenance should be performed as needed. Terraces should be inspected regularly; at least once a year, and after large storm events.

## BMP C140: Dust Control

---

### Purpose and Description

Dust control prevents wind transport of dust from disturbed soil surfaces onto roadways, drainage ways, and surface waters.

### Conditions of Use

- In areas (including roadways) subject to surface and air movement of dust where on-site and off-site impacts to roadways, drainage ways, or surface waters are likely.

### Design Criteria

- Vegetate or mulch areas that will not receive vehicle traffic. In areas where planting, mulching, or paving is impractical, apply gravel or landscaping rock.
- Limit dust generation by clearing only those areas where immediate activity will take place, leaving the remaining area(s) in the original condition. Maintain the original ground cover as long as practical.
- Construct natural or artificial windbreaks or windscreens. These may be designed as enclosures for small dust sources.
- Sprinkle the site with water until surface is wet. Repeat as needed. To prevent carryout of mud onto street, refer to Stabilized Construction Entrance ([BMP C105](#)).
- Irrigation water can be used for dust control. Irrigation systems should be installed as a first step on sites where dust control is a concern.
- Spray exposed soil areas with a dust palliative, following the manufacturer's instructions and cautions regarding handling and application. Used oil is prohibited from use as a dust suppressant.
- PAM ([BMP C126](#)) added to water at a rate of 0.5 lbs. per 1,000 gallons of water per acre and applied from a water truck is more effective than water alone. This is due to increased infiltration of water into the soil and reduced evaporation. In addition, small soil particles are bonded together and are not as easily transported by wind. Adding PAM may actually reduce the quantity of water needed for dust control. Use of PAM could be a cost-effective dust control method.

Techniques that can be used for unpaved roads and lots include:

- Lower speed limits. High vehicle speed increases the amount of dust stirred up from unpaved roads and lots.
- Upgrade the road surface strength by improving particle size, shape, and mineral types that make up the surface and base materials.



- Add surface gravel to reduce the source of dust emission. Limit the amount of fine particles (those smaller than .075 mm) to 10 to 20 percent.
- Use geotextile fabrics to increase the strength of new roads or roads undergoing reconstruction.
- Encourage the use of alternate, paved routes, if available.
- Restrict use of paved roadways by tracked vehicles and heavy trucks to prevent damage to road surface and base.
- Apply chemical dust suppressants using the admix method, blending the product with the top few inches of surface material. Suppressants may also be applied as surface treatments.
- Pave unpaved permanent roads and other trafficked areas.
- Use vacuum street sweepers.
- Remove mud and other dirt promptly so it does not dry and then turn into dust.
- Limit dust-causing work on windy days.
- Contact the Southwest Washington Clean Air Agency <http://www.swcleanair.org/> for guidance and training on control measures. Compliance with the local Air Pollution Control Authority constitutes compliance with this BMP.

## Maintenance Standards

Respray area as necessary to keep dust to a minimum.

## BMP CI50: Materials on Hand

---

### Purpose and Description

Keep quantities of erosion prevention and sediment control materials on the project site at all times to be used for regular maintenance and emergency situations such as unexpected heavy summer rains. Having these materials on-site reduces the time needed to implement BMPs when inspections indicate that existing BMPs are not meeting the Construction SWPPP requirements.

### Conditions of Use

- Construction projects of any size or type can benefit from having materials on hand. A small commercial development project could have a roll of plastic and some gravel available for immediate protection of bare soil and temporary berm construction. A large earthwork project, such as highway construction, might have several tons of straw, several rolls of plastic, flexible pipe, sandbags, geotextile fabric and steel “T” posts.
- Materials are stockpiled and readily available before any site clearing, grubbing, or earthwork begins. A large contractor or developer could keep a stockpile of materials that are available for use on several projects.
- If storage space at the project site is at a premium, the contractor could maintain the materials at their office or yard, provided that the office or yard is less than an hour from the project site.

### Design Criteria

Depending on project type, size, complexity, and length, materials and quantities will vary. A good minimum list of items that will cover numerous situations includes:

- Clear Plastic, 6mil
- Drainpipe, 6 or 8 inch diameter
- Sandbags, filled
- Straw bales for mulching
- Quarry spalls
- Washed gravel
- Geotextile fabric
- Catch basin inserts
- Steel “T” posts
- Silt fence material
- Straw wattles

## Maintenance Standards

- All materials with the exception of the quarry spalls, steel “T” posts, and gravel should be kept covered and out of both sun and rain.
- Re-stock materials used as needed.

## BMP C151: Concrete Handling

---

### Purpose and Description

Proper handling and disposal of excess concrete, concrete process water, and concrete slurry prevents these materials from entering waters of the state. Discharge of concrete materials to the County storm drainage system and surface water is a violation of County code and state law.

### Conditions of Use

Any time concrete is used, utilize these management practices. Concrete construction projects include, but are not limited to, the following:

- Curbs
- Sidewalks
- Roads
- Bridges
- Foundations
- Floors
- Runways

### Design Criteria

- Assure that washout of concrete trucks, chutes, pumps, and internals is performed at an approved off-site location or in designated concrete washout areas ([BMP C154](#)). Do not wash out concrete trucks onto the ground, or into storm drains, open ditches, streets, or streams.
- Return unused concrete remaining in the truck and pump to the originating batch plant for recycling. Do not dump excess concrete on site, except in designated concrete washout areas.
- Wash off hand tools including, but not limited to, screeds, shovels, rakes, floats, and trowels into formed areas only.
- Wash equipment difficult to move, such as concrete pavers, in areas that do not directly drain to natural or constructed stormwater conveyances.
- Do not allow washdown from areas, such as concrete aggregate driveways, to drain directly to natural or constructed stormwater conveyances.
- When no formed areas are available, contain washwater and leftover product in a lined container. Dispose of contained concrete in a manner that does not violate groundwater or surface water quality standards, and dispose of concrete process water as wastewater.
- Always use forms or solid barriers for concrete pours, such as pilings, within 15-feet of surface waters.

- Refer to BMPs [C252](#) and [C253](#) for pH adjustment to stormwater that has come into contact with fresh concrete.
- Refer to the Construction Stormwater General Permit for pH monitoring requirements if the project involves one of the following activities:
  - Significant concrete work (greater than 1,000 cubic yards poured concrete or recycled concrete used over the life of the project).
  - The use of engineered soils amended with (but not limited to) Portland cement-treated base, cement kiln dust or fly ash.
  - Discharging stormwater to segments of water bodies on the 303(d) list (Category 5) for high pH.

Search the 303(d) list here: <https://fortress.wa.gov/ecy/wats/approvedsearch.aspx>

## Maintenance Standards

Check containers for holes in the liner daily during concrete pours and repair the same day.

## BMP CI52: Sawcutting and Surfacing Pollution Prevention

---

### Purpose and Description

Proper handling and disposal of slurry and process water from sawcutting and surfacing operations prevents these materials from entering waters of the state and the County drainage systems. Discharge of concrete materials to the County storm drainage system and surface water is a violation of County code and state law.

### Conditions of Use

Utilize these management practices anytime sawcutting or surfacing operations take place. Sawcutting and surfacing operations include, but are not limited to, the following:

- Sawing
- Coring
- Grinding
- Roughening
- Hydro-demolition
- Bridge and road surfacing

### Design Criteria

- Vacuum slurry and cuttings during cutting and surfacing operations.
- Slurry and cuttings shall not remain on permanent concrete or asphalt pavement overnight.
- Slurry and cuttings shall not drain to any natural or constructed drainage conveyance including stormwater systems. This may require temporarily blocking catch basins.
- Dispose of collected slurry and cuttings in a manner that does not violate groundwater or surface water quality standards.
- Do not allow process water generated during hydro-demolition, surface roughening or similar operations to drain to any natural or constructed drainage conveyance including stormwater systems. Dispose process water in a manner that does not violate groundwater or surface water quality standards.
- Handle and dispose cleaning waste material and demolition debris in a manner that does not cause contamination of water. Dispose of sweeping material from a pick-up sweeper at an appropriate disposal site.

## Maintenance Standards

Continually monitor operations to determine whether slurry, cuttings, or process water could enter waters of the state. If inspections show that a violation of water quality standards could occur, stop operations and immediately implement preventive measures such as berms, barriers, secondary containment, and vacuum trucks.

## BMP CI53: Material Delivery, Storage and Containment

---

### Purpose and Description

Prevent, reduce, or eliminate the discharge of pollutants to the stormwater system or watercourses from material delivery and storage. Minimize the storage of hazardous materials on-site, store materials in a designated area, and install secondary containment.

Refer to [Book 3](#) for specific BMPs to control pollutants for materials delivery, storage, use and containment.

### Conditions of Use

These procedures are suitable for use at all construction sites with delivery and storage of the following materials:

- Petroleum products such as fuel, oil and grease
- Soil stabilizers and binders (e.g. Polyacrylamide)
- Fertilizers, pesticides and herbicides
- Detergents
- Asphalt and concrete compounds
- Hazardous chemicals such as acids, lime, adhesives, paints, solvents and curing compounds
- Any other material that may be detrimental if released to the environment

### Design Criteria

The following steps should be taken to minimize risk:

- Temporary storage area should be located away from vehicular traffic, near the construction entrance(s), and away from waterways or storm drains.
- Material Safety Data Sheets (MSDS) should be supplied for all materials stored. Chemicals should be kept in their original labeled containers.
- Hazardous material storage on-site should be minimized.
- Hazardous materials should be handled as infrequently as possible.
- During the wet weather season (Oct 1 – April 30), consider storing materials in a covered area.
- Materials should be stored in secondary containments, such as earthen dike, horse trough, or even a children's wading pool for non-reactive materials such as detergents, oil, grease, and paints. Small amounts of material may be secondarily contained in "bus boy" trays or concrete mixing trays.



- Do not store chemicals, drums, or bagged materials directly on the ground. Place these items on a pallet and, when possible, and within secondary containment.
- If drums must be kept uncovered, store them at a slight angle to reduce ponding of rainwater on the lids to reduce corrosion. Domed plastic covers are inexpensive and snap to the top of drums, preventing water from collecting.

**Material Storage Areas and Secondary Containment Practices:**

- Liquids, petroleum products, and substances listed in 40 CFR Parts 110, 117, or 302 shall be stored in approved containers and drums and shall not be overfilled. Containers and drums shall be stored in temporary secondary containment facilities.
- Temporary secondary containment facilities shall provide for a spill containment volume able to contain 10% of the total enclosed container volume of all containers, or 110% of the capacity of the largest container within its boundary, whichever is greater.
- Secondary containment facilities shall be impervious to the materials stored therein for a minimum contact time of 72 hours.
- Secondary containment facilities shall be maintained free of accumulated rainwater and spills. In the event of spills or leaks, accumulated rainwater and spills shall be collected and placed into drums. These liquids shall be handled as hazardous waste unless testing determines them to be non-hazardous.
- Sufficient separation should be provided between stored containers to allow for spill cleanup and emergency response access.
- During the wet weather season (Oct 1 – April 30), each secondary containment facility shall be covered during non-working days, prior to and during rain events.
- Keep material storage areas clean, organized and equipped with an ample supply of appropriate spill clean-up material (spill kit).
- The spill kit should include, at a minimum:
  - 1-Water Resistant Nylon Bag
  - 3-Oil Absorbent Socks 3”x 4’
  - 2-Oil Absorbent Socks 3”x 10’
  - 12-Oil Absorbent Pads 17”x19”
  - 1-Pair Splash Resistant Goggles
  - 3-Pair Nitrile Gloves
  - 10-Disposable Bags with Ties

## BMP CI54: Concrete Washout Facilities

---

### Purpose and Description

Prevent or reduce the discharge of pollutants to stormwater from concrete waste by conducting washout off-site, or performing on-site washout in a designated area to prevent pollutants from entering surface waters or groundwater.

Discharge of concrete materials to the County storm drainage system and surface water is a violation of County code and state law.

### Conditions of Use

Concrete washout area best management practices are implemented on construction projects where:

- Concrete is used as a construction material
- It is not possible to dispose of all concrete wastewater and washout off-site (ready mix plant, etc.).
- Concrete trucks, pumpers, or other concrete coated equipment are washed on-site.

Usage Instructions:

- Perform washout of concrete trucks at an approved off-site location or in designated concrete washout areas only.
- Do not wash out concrete trucks onto the ground, or into storm drains, open ditches, streets, or streams.
- Do not allow excess concrete to be dumped on-site, except in designated concrete washout areas.
- Concrete washout facility shall be constructed and maintained in sufficient quantity and size to contain all liquid and concrete waste generated by washout operations.

### Design Criteria

#### Design

- Concrete washout areas may be prefabricated concrete washout containers, or self-installed structures (above-grade or below-grade).
  - If self-installed concrete washout areas are used, below-grade structures are preferred over above-grade structures because they are less prone to spills and leaks.
  - Self-installed above-grade structures should only be used if excavation is not practical.
- The total volume of all concrete washout facilities must be adequate to contain all liquid and concrete waste generated by washout operations.

### Location and Placement

- All washout facilities shall be located at least 50 feet from storm drains, open ditches, or water bodies, including wetlands.
- If trucks need to leave a paved area to access washout, prevent track-out with a pad of rock or quarry spalls (see [BMP C105](#)). These areas should be far enough away from other construction traffic to reduce the likelihood of accidental damage and spills.

### On-site Temporary Concrete Washout Facility, Transit Truck Washout Procedures

- Concrete washout from concrete pumper bins can be washed into concrete pumper trucks and discharged into designated washout area or properly disposed of off-site.
- Once concrete wastes are washed into the designated area and allowed to harden, the concrete should be broken up, removed, and disposed of per applicable solid waste regulations. Dispose of hardened concrete on a regular basis.
- Place a secure, non-collapsing, non-water collecting cover over the concrete washout facility prior to predicted wet weather to prevent accumulation and overflow of precipitation.
- Perform washout of concrete trucks off-site or in designated concrete washout areas only.
- If less than 10 concrete trucks or pumpers need to be washed out on-site, the washwater may be disposed of in a formed area awaiting concrete or an upland disposal site where it will not contaminate surface or groundwater. The upland disposal site shall be at least 50 feet from sensitive areas such as storm drains, open ditches, or water bodies, including wetlands.

### Temporary Above-Grade Concrete Washout Facility

- Temporary concrete washout facility (above grade) should be constructed as shown on the details below, with a recommended minimum length and minimum width of 10 feet.
- Plastic lining material should be a minimum of 10 mil polyethylene sheeting and must be free of holes, tears, or other defects that compromise the impermeability of the material.

### Temporary Below-Grade Concrete Washout Facility

- Temporary concrete washout facilities (below grade) should be constructed as shown on the details below, with a recommended minimum length and minimum width of 10 feet.
- Lath and flagging should be commercial type.
- Plastic lining material shall be a minimum of 10 mil polyethylene sheeting and must be free of holes, tears, or other defects that compromise the impermeability of the material.
- Liner seams shall be installed in accordance with manufacturers' recommendations.
- Soil base shall be prepared free of rocks or other debris that may cause tears or holes in the plastic lining material.

## Education

- Discuss the concrete management techniques described in this BMP with the ready-mix concrete supplier, employees and subcontractors before concrete operations begin.
- Arrange for contractor's superintendent or Certified Erosion and Sediment Control Lead (CESCL) to oversee and enforce concrete waste management procedures.
- Install a sign adjacent to each temporary concrete washout facility to inform concrete equipment operators to utilize the proper facilities.
- Consider using contract agreements with suppliers and contractors to address these requirements.

## Maintenance Standards

### Inspection

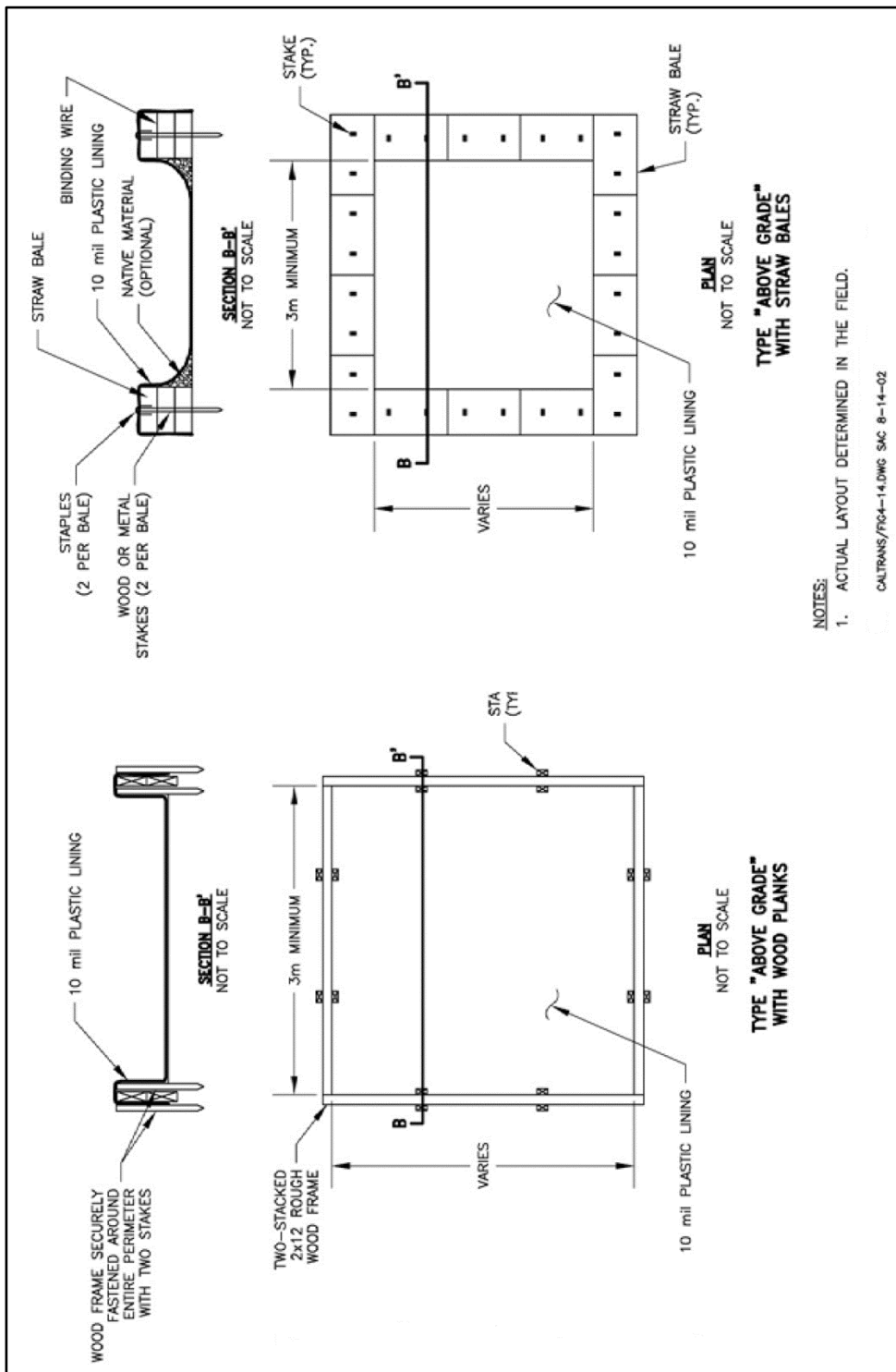
- Inspect and verify that concrete washout BMPs are in place prior to the commencement of concrete work.
- During periods of concrete work, inspect daily to verify continued performance.
  - Check overall condition and performance.
  - Check remaining capacity.
  - If using self-installed washout facilities, verify plastic liners are intact and sidewalls are not damaged.
  - If using prefabricated containers, check for leaks.
- Inspect each facility after removal of materials for signs of weakening or damage.

### Maintenance

- Facilities must be repaired when signs of weakening or damage are present.
- Washout facilities shall be maintained to provide adequate holding capacity with a minimum freeboard of 12 inches.
- Washout facilities must be cleaned, or new facilities must be constructed and ready for use once the washout is 75% full.
- If the washout is nearing capacity, vacuum and dispose of the waste material in an approved manner.
  - Do not discharge liquid or slurry to waterways, storm drains or directly onto ground.
  - Do not use sanitary sewer without approval from the local sewer authority. Remove and dispose of hardened concrete and return the structure to a functional condition. Concrete may be reused on-site or hauled away for disposal or recycling.
- After each cleaning (removal of materials), re-line the structure with new plastic liners.

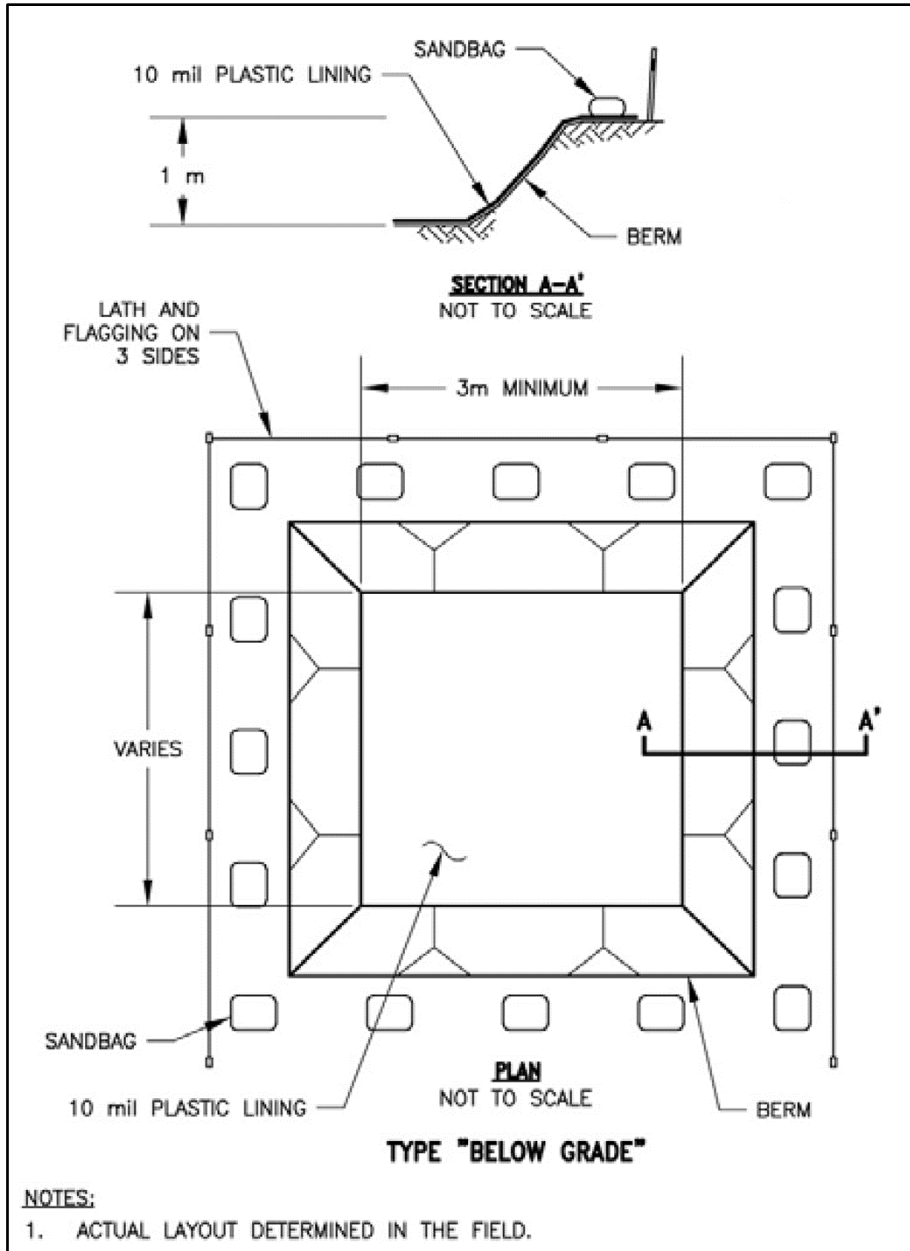
### Removal of Temporary Concrete Washout Facilities

- When temporary concrete washout facilities are no longer required for the work, the hardened concrete, slurries and liquids shall be removed and properly disposed of.
- Materials used to construct temporary concrete washout facilities shall be removed from the site of the work and disposed of or recycled.
- Holes, depressions or other ground disturbance caused by the removal of the temporary concrete washout facilities shall be backfilled, repaired, and stabilized to prevent erosion.



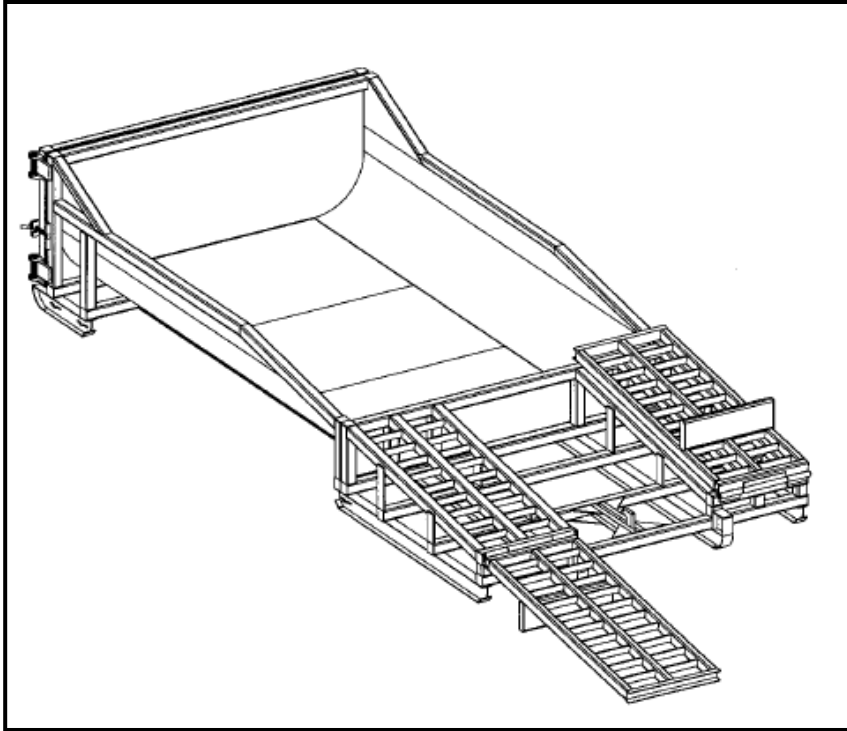
**Figure 8.9: Concrete Washout Area – Above Grade Options**

(Source: modified from Stormwater Management Manual for Western Washington, 2014)



**Figure 8.10: Concrete Washout Area – Below Grade**

(Source: modified from Stormwater Management Manual for Western Washington, 2014)



**Figure 8.11: Prefabricated Concrete Washout Container with Ramp**

(Source: Stormwater Management Manual for Western Washington, 2014)



## BMP C160: Certified Erosion and Sediment Control Lead (CESCL)

---

### Purpose and Description

The project proponent designates at least one person as the responsible representative in charge of erosion and sediment control (ESC), and water quality protection. The designated person shall be the Certified Erosion and Sediment Control Lead (CESCL) who is responsible for ensuring compliance with all local, state, and federal erosion and sediment control and water quality requirements.

### Conditions of Use

The CESCL shall:

- Have a current certificate proving attendance in an erosion and sediment control training course that meets the minimum ESC training and certification requirements established by Ecology (see details below). Ecology will maintain a list of ESC training and certification providers at: <http://www.ecy.wa.gov/programs/wq/stormwater/cescl.html>

OR

- Be a Certified Professional in Erosion and Sediment Control (CPESC); for additional information go to: [www.cpesc.net](http://www.cpesc.net)

### Specifications

- The CESCL shall have authority to act on behalf of the contractor or developer and shall be available, or on-call, 24 hours per day throughout the period of construction.
- A CESCL may provide inspection and compliance services for multiple construction projects in the same geographic region.

Duties and responsibilities of the CESCL shall include, but are not limited to the following:

- Maintaining permit file on site at all times which includes the Construction SWPPP and any associated permits and plans.
- Directing BMP installation, inspection, maintenance, modification, and removal.
- Updating all project drawings and the Construction SWPPP with changes made.
- Facilitate, participate in, and take corrective actions resulting from inspections performed by outside agencies or the owner.
- Keeping daily logs, and inspection reports. Inspection reports should include:
  - Inspection date/time.

- Weather information; general conditions during inspection and approximate amount of precipitation since the last inspection.
- A summary or list of all BMPs implemented, including observations of all erosion/sediment control structures or practices. The following shall be noted:
  1. Locations of BMPs inspected.
  2. Locations of BMPs that need maintenance.
  3. Locations of BMPs that failed to operate as designed or intended.
  4. Locations of where additional or different BMPs are required.
- Visual monitoring results, including a description of discharged stormwater. The presence of suspended sediment, turbid water, discoloration, and oil sheen shall be noted, as applicable.
- Any water quality monitoring performed during inspection.
- General comments and notes, including a brief description of any BMP repairs, maintenance or installations made as a result of the inspection.

## BMP C162: Construction Sequence Schedule

---

### Purpose and Description

Sequencing a construction project reduces the amount and duration of soil exposed to erosion by wind, rain, runoff, and vehicle tracking.

### Conditions of Use

The construction sequence schedule is an orderly listing of all major land-disturbing activities together with the necessary erosion and sedimentation control measures planned for the project. The schedule guides the contractor on work to be done before other work is started so that serious erosion and sedimentation problems can be avoided.

Following a specified work schedule that coordinates the timing of land-disturbing activities and the installation of control measures is perhaps the most cost-effective way of controlling erosion during construction. The removal of surface ground cover leaves a site vulnerable to accelerated erosion. Construction procedures that limit land clearing, provide timely installation of erosion and sedimentation controls, and restore protective cover quickly can significantly reduce the erosion potential of a site.

### Design Considerations

- Minimize construction during rainy periods.
- Schedule projects to disturb only small portions of the site at any one time. Complete grading as soon as possible. Immediately stabilize the disturbed portion before grading the next portion. Practice staged seeding in order to revegetate cut and fill slopes as the work progresses.

## BMP C200: Interceptor Dike and Swale

---

### Purpose and Description

An interceptor dike or swale is a ridge of compacted soil, or a ridge with an upslope swale, at the top or base of a disturbed slope or along the perimeter of a disturbed construction area used to intercept and convey stormwater. Use the dike and/or swale to intercept the runoff from unprotected areas and direct it to areas where erosion can be controlled. This can prevent storm runoff from entering the work area or sediment-laden runoff from leaving the construction site.

### Conditions of Use

Use an interceptor dike or swale where the runoff from an exposed site or disturbed slope must be conveyed to an erosion control facility which can safely convey the stormwater.

- Locate upslope of a construction site to prevent runoff from entering disturbed area.
- To reduce the amount and velocity of runoff flowing down a disturbed slope, place horizontally across a disturbed slope.
- Locate downslope to collect runoff from a disturbed area and direct water to a sediment basin.

### Design Criteria

- Dike and/or swale and channel must be stabilized with temporary or permanent vegetation or other channel protection during construction.
- Channel requires a positive grade for drainage; steeper grades require channel protection and check dams.
- Review construction for areas where overtopping may occur.
- Can be used at top of new fill before vegetation is established.
- May be used as a permanent diversion channel to carry the runoff.
- Sub-basin tributary area should be one acre or less.
- For temporary facilities, design capacity for the peak flow from a 10-year, 24-hour storm, assuming a Type 1A rainfall distribution or use 1.6 times the 10-year, 1-hour flow indicated by an approved continuous flow model.
- For facilities that will also serve on a permanent basis, consult [Book 2, Chapter 7](#) for design requirements.

## Interceptor Dikes

Interceptor dikes shall meet the following criteria:

- The upslope side of the dike shall provide positive drainage to the dike outlet. No erosion shall occur at the outlet. Provide energy dissipation measures as necessary. Sediment-laden runoff must be released through a sediment trapping facility.
- Minimize construction traffic over temporary dikes. Use temporary cross culverts for channel crossings.

Top Width	2 feet minimum
Height	1.5 feet minimum on berm
Side Slope	2H:1V or flatter
Grade	Depends on topography; however, dike system minimum is 0.5% and maximum is 1%
Compaction	Minimum of 90% ASTM D698 standard proctor

## Horizontal Spacing

Average Slope	Slope Percent	Flow path Length
20H:1V or less	3-5%	300 feet
(10 to 20)H:1V	5-10%	200 feet
(4 to 10)H:1V	10-25%	100 feet
(2 to 4)H:1V	25-50%	50 feet

## Stabilization

Stabilization depends on velocity and reach.

Slopes <5% Seed and mulch applied within 5 days of dike construction (see [BMP C121](#), Mulching).

Slopes 5 - 40% Dependent on runoff velocities and dike materials. Stabilization should be done immediately using either sod or riprap or other measures to avoid erosion.

## Interceptor Swales

Interceptor swales shall meet the following criteria:

Bottom Width	2 feet minimum; the cross-section bottom shall be level
Depth	1 foot minimum
Side Slope	2H:1V or flatter
Grade	Maximum 5%, with positive drainage to a suitable outlet (such as a sediment pond)

### Stabilization

Stabilization Seed as per [BMP C120](#), Temporary and Permanent Seeding, or [BMP C202](#), Channel Lining, 12 inches thick riprap pressed into the bank and extending at least 8 inches vertical from the bottom.

### Maintenance

- Inspect diversion dikes and interceptor swales once a week and after every rainfall. Immediately remove sediment from the flow area.
- Damage caused by construction traffic or other activity must be repaired before the end of each working day.
- Check outlets and make timely repairs as needed to avoid gully formation. When the area below the temporary diversion dike is permanently stabilized, remove the dike, then fill and stabilize the channel to blend with the natural surface.

## BMP C201: Grass-Lined Channels

---

### Purpose and Description

Grass-lined channels convey stormwater runoff. See [Figure 8.12](#) for typical grass-lined channels.

### Conditions of Use

This practice applies to construction sites where concentrated runoff needs to be contained to prevent erosion or flooding.

- When a vegetative lining can provide sufficient stability for the channel cross-section and at lower velocities of water (normally dependent on grade). This means that the channel slopes are generally less than 5 percent and space is available for a relatively large cross-section.
- Typical uses include roadside ditches, channels at property boundaries, outlets for diversions, and other channels and drainage ditches in low areas.

### Design Criteria

- Grass-lined channels that will also function as a permanent stormwater conveyance facilities shall be designed in accordance with [Book 2, Chapter 7](#).

### Location

- Locate the channel where it can conform to the topography and other features such as roads.
  - Locate them to use natural drainage systems to the greatest extent possible.
  - Avoid sharp changes in alignment or bends and changes in grade.
  - Do not reshape the landscape to fit the drainage channel.

### Shape and Side Slope

- V-shaped grass channels generally apply where the quantity of water is small, such as in short reaches along roadsides. The V-shaped cross-section is least desirable because it is difficult to stabilize the bottom where velocities may be high.
- Trapezoidal grass channels are used where runoff volumes are large and slope is low so that velocities are non-erosive to vegetated linings. (Note: it is difficult to construct small parabolic shaped channels.)
- Grassed channel side slopes generally are constructed 3H:1V or flatter to aid in the establishment of vegetation and for maintenance.
- Construct channels a minimum of 0.2 foot larger around the periphery to allow for soil bulking during seedbed preparations and sod buildup.

## Design Flow

- The maximum design velocity shall be based on soil conditions, type of vegetation, and method of revegetation, but at no times shall velocity exceed 5 feet/second. The channel shall not be overtopped by the peak runoff from a 10-year, 24-hour storm, assuming a Type 1A rainfall distribution. Alternatively, use 1.6 times the 10-year, 1-hour flow indicated by an approved continuous flow model to determine a flow rate which the channel must contain.
- Grass channels, at a minimum, should carry peak runoff for temporary construction drainage facilities from the 10-year, 24-hour storm without eroding. Where flood hazard exists, increase the capacity according to the potential damage.

## Vegetation and Erosion Protection

- Vegetated channels should be installed before major earthwork and hydroseeded with a bonded fiber matrix (BFM). The vegetation must be well established (i.e., 75 percent cover) before water is allowed to flow in the ditch, unless stabilized with nets or blankets.
- If design velocity of a channel to be vegetated by seeding exceeds 2 ft/sec, a temporary channel liner is required. Geotextile or special mulch protection such as fiberglass roving or straw and netting provides stability until the vegetation is fully established. See [Figure 8.13](#).
- Channels that will carry high flows should have erosion control blankets installed over the hydroseed. If vegetation cannot be established from seed before water is allowed in the ditch, sod should be installed in the ditch in lieu of hydromulch and blankets.
- If vegetation is established by sodding, the permissible velocity for established vegetation may be used and no temporary liner is needed.
- Check dams shall be removed when the grass has matured sufficiently to protect the ditch or swale unless the slope of the swale is greater than 4 percent. The area beneath the check dams shall be seeded and mulched immediately after dam removal.
- Subsurface drainage, or riprap channel bottoms, may be necessary on sites that are subject to prolonged wet conditions due to long duration flows or a high water table.
- Provide outlet protection at culvert ends and at channel intersections.

## Sediment

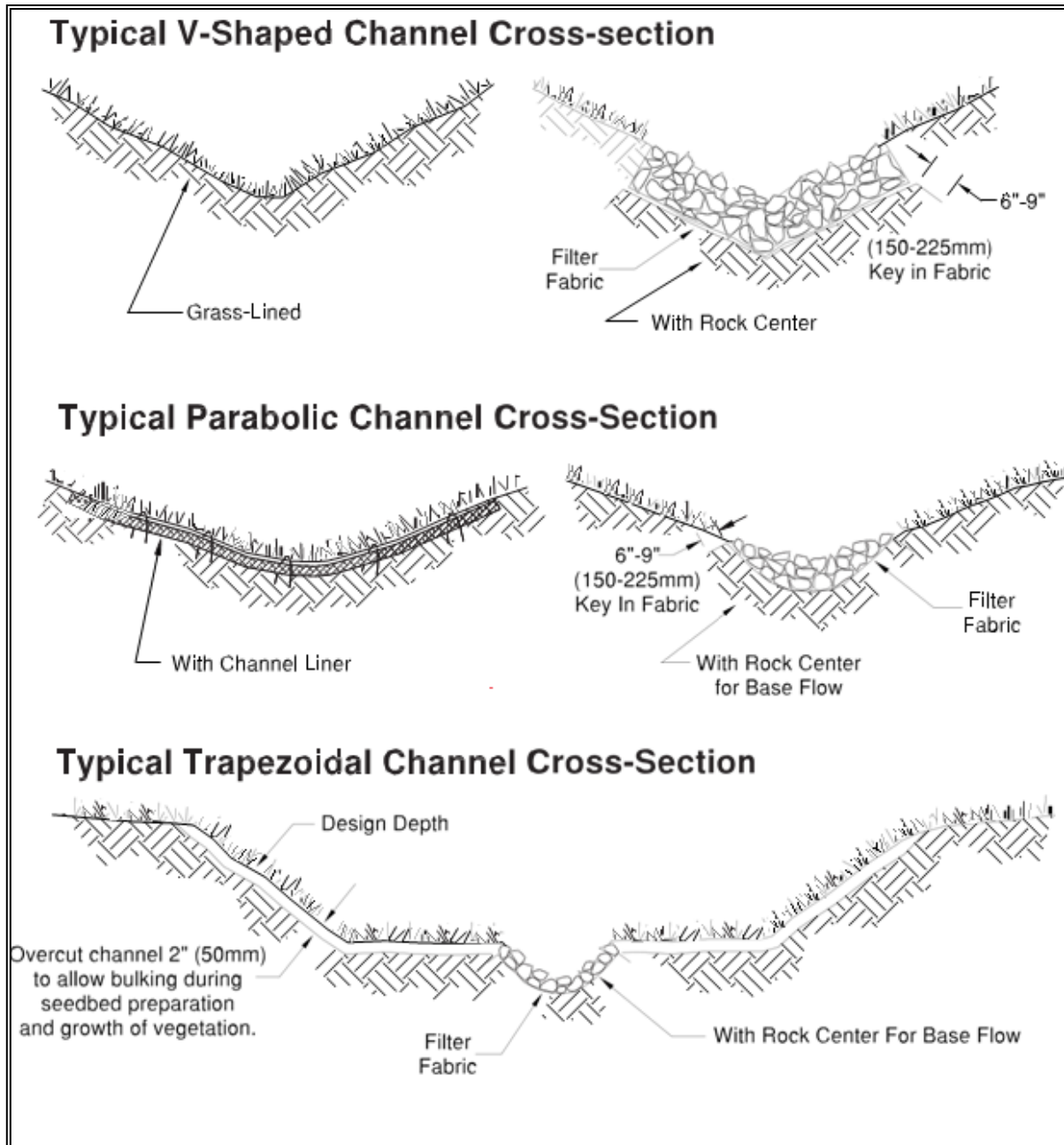
- Do not subject grass-lined channel to sedimentation from disturbed areas. Use sediment-trapping BMPs upstream of the channel.

## Maintenance Standards

- During the establishment period, check grass-lined channels after every rainfall that produces runoff.
- After grass is established, periodically check the channel; check it after every heavy rainfall event. Immediately make repairs.

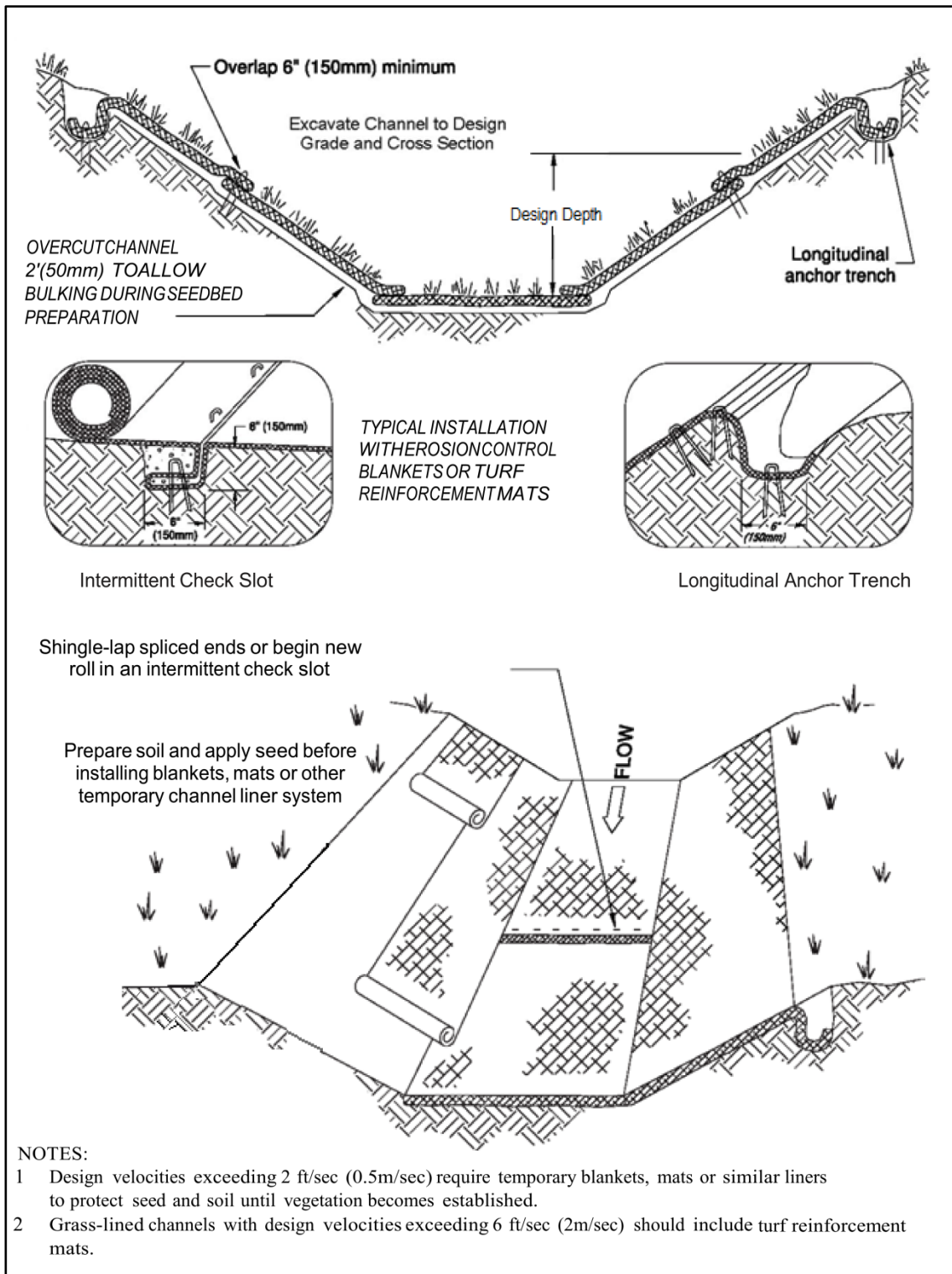


- It is particularly important to check the channel outlet and all road crossings for bank stability and evidence of piping or scour holes.
- Remove all significant sediment accumulations to maintain the designed carrying capacity. Keep the grass in a healthy, vigorous condition at all times, since it is the primary erosion protection for the channel.



**Figure 8.12: Typical Grass-Lined Channels**

(Source: SMMWW)



**Figure 8.13: Temporary Channel Liners**

(Source: SMMWW)

## BMP C202: Channel Lining

---

### Purpose and Description

To protect channels by providing a channel liner using either blankets or riprap.

### Conditions of Use

Use channel lining when natural soils or vegetated stabilized soils in a channel are not adequate to prevent channel erosion or when a permanent ditch or pipe system is to be installed and a temporary measure is needed to prevent erosion.

### Design Criteria

#### Selecting a Material

- In almost all cases, synthetic and organic coconut blankets are more effective than riprap for protecting channels from erosion. Blankets can be used with and without vegetation. Blanketed channels can be designed to handle any expected flow and longevity requirement. Some synthetic blankets have a predicted life span of 50 years or more, even in sunlight.
- Blankets usually require manual labor to place while rock for riprap usually requires heavy equipment to place.
- The Federal Highway Administration recommends not using flexible liners whenever the slope exceeds 10 percent or the shear stress exceeds 8 lbs/ft<sup>2</sup>.

#### Blankets

Erosion control blankets shall conform to the requirements of [BMP C122](#), Nets and Blankets.

#### Riprap

Since riprap is used where erosion potential is high, construction must be sequenced so that the riprap is put in place with the minimum possible delay.

- Disturbance of areas where riprap is to be placed should be undertaken only when final preparation and placement of the riprap can follow immediately behind the initial disturbance. Where riprap is used for outlet protection, the riprap should be placed before or in conjunction with the construction of the pipe or channel so that it is in place when the pipe or channel begins to operate.
- The designer, after determining the riprap size that will be stable under the flow conditions, shall consider that size to be a minimum size and then, based on riprap gradations actually available in the area, select the size or sizes that equal or exceed the minimum size.

- Stone for riprap shall consist of field stone or quarry stone of approximately rectangular shape. The stone shall be hard and angular and of such quality that it will not disintegrate on exposure to water or weathering and it shall be suitable in all respects for the purpose intended.
- A lining of engineering filter fabric (geotextile) shall be placed between the riprap and the underlying soil surface to prevent soil movement into or through the riprap. The geotextile should be keyed in at the top of the bank.
- Filter fabric shall not be used on slopes greater than 1-1/2H:1V as slippage may occur. It should be used in conjunction with a layer of coarse aggregate (granular filter blanket) when the riprap to be placed is 12 inches and larger.

## BMP C203: Water Bars

---

### Purpose and Description

A small ditch or ridge of material is constructed diagonally across a road or right-of-way to divert stormwater runoff from the road surface, wheel tracks, or a shallow road ditch.

### Conditions of Use

Clearing right-of-way and construction of access for power lines, pipelines, and other similar installations often require long narrow right-of-ways over sloping terrain. Disturbance and compaction promotes gully formation in these cleared strips by increasing the volume and velocity of runoff. Gully formation may be especially severe in tire tracks and ruts. To prevent gullying, runoff can often be diverted across the width of the right-of-way to undisturbed areas by using small predesigned diversions.

Give special consideration to each individual outlet area, as well as to the cumulative effect of added diversions. Use gravel to stabilize the diversion where significant vehicular traffic is anticipated.

### Design Criteria

Height: 8-inch minimum measured from the channel bottom to the ridge top.

- Side slope of channel: 2H:1V maximum; 3H:1V or flatter when vehicles will cross.
- Base width of ridge: 6-inch minimum.
- Locate them to use natural drainage systems and to discharge into well-vegetated stable areas.

Guideline for Spacing:

Slope %	Spacing (ft)
< 5	125
5 - 10	100
10 - 20	75
20 - 35	50
> 35	Use rock lined ditch

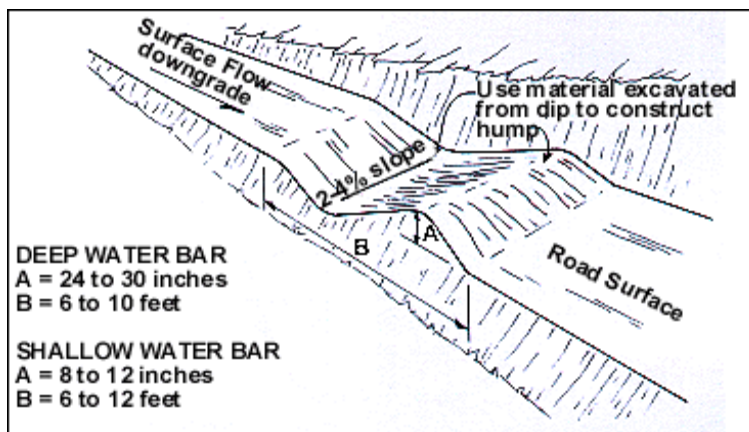
- Grade of water bar and angle: Select angle that results in ditch slope less than 2 percent.
- Install as soon as the clearing and grading is complete. Reconstruct when construction is complete on a section when utilities are being installed.
- Compact the ridge when installed.

- Stabilize, seed and mulch the portions that are not subject to traffic. Gravel the areas crossed by vehicles.

## Maintenance Standards

Periodically inspect right-of-way diversions for wear and after every heavy rainfall for erosion damage.

- Immediately remove sediment from the flow area and repair the dike.
- Check outlet areas and make timely repairs as needed.
- When permanent road drainage is established and the area above the temporary right-of-way diversion is permanently stabilized, remove the dikes and fill the channels to blend with the natural ground and appropriately stabilize the disturbed area.



**Figure 8.14: Water Bar**

(Source: SMMWW)

## BMP C204: Pipe Slope Drains

---

### Purpose and Description

Pipe slope drains are used to convey stormwater after it is diverted away from or over bare soil to prevent gullies, channel erosion, and saturation of slide-prone soils.

### Conditions of Use

Pipe slope drains should be used when a temporary or permanent stormwater conveyance is needed to move the water down a steep slope to avoid erosion

On highway projects, pipe slope drains should be used at bridge ends to collect runoff and pipe it to the base of the fill slopes along bridge approaches. Another use on road projects is to collect runoff from pavement and pipe it away from side slopes at least until curbs, gutters, and permanent drainage facilities are installed. Pipe slope drains may be used effectively in conjunction with sand bags, triangular silt dikes or other temporary diversion devices.

Pipe slope drains can be:

- Connected to new catch basins and used temporarily until all permanent piping is installed.
- Used to drain water collected from aquifers exposed on cut slopes and take it to the base of the slope.
- Used to collect clean runoff from plastic sheeting and direct it away from exposed soil.
- Installed in conjunction with silt fence to drain collected water to a controlled area.
- Used to divert small seasonal streams away from construction. They have been used successfully on culvert replacement and extension jobs. Large flex pipe can be used on larger streams during culvert removal, repair, or replacement.
- Connected to existing down spouts and roof drains and used to divert water away from work areas during building renovation, demolition, and construction projects.

There are now several commercially available collectors that are attached to the pipe inlet and help prevent erosion at the inlet.

### Design Criteria

Pipe slope drains that will operate as permanent facilities must be designed and installed in accordance with [Book 2, Chapter 7](#).

## Design Flow

The capacity for temporary drains shall be sufficient to handle the peak flow from a 10-year, 24-hour storm event, assuming a Type 1A rainfall distribution. Alternatively, use 1.6 times the 10-year, 1-hour flow indicated by an approved continuous flow model. The hydrologic analysis must use the existing land cover condition for predicting flow rates from tributary areas outside the project limits. For tributary areas on the project site, the analysis must use the temporary or permanent project land cover condition, whichever will produce the highest flow rates. If using the Western Washington Hydrology Model (WWHM) to predict flows, bare soil areas should be modeled as "landscaped" area

## Materials

- Materials specifications for any permanent piped system shall be set by the Responsible Official.

## Pipe Entrance

- Piping of water through the berm at the entrance area is a common failure mode. Pay special attention to construction of the pipe entrance to avoid piping.
- Use diversion dikes or swales to collect water at the top of the slope.
- Ensure that the entrance area is stable and large enough to direct flow into the pipe.
- The entrance shall consist of a standard flared end section for culverts 12 inches and larger with a minimum 6-inch metal toe plate to prevent runoff from undercutting the pipe inlet. The slope of the entrance shall be at least 3 percent. Sand bags may also be used at pipe entrances as a temporary measure.
- The soil around and under the pipe and entrance section shall be thoroughly compacted to prevent undercutting.
- The flared inlet section shall be securely connected to the slope drain and have watertight connecting bands.
- Interceptor dikes shall be used to direct runoff into a slope drain. The height of the dike shall be at least 1 foot higher at all points than the top of the inlet pipe.

## Clearing

- Use care in clearing vegetated slopes for installation.
- Re-establish cover immediately on areas disturbed by installation.
- Use temporary drains on new cut or fill slopes.

## Connections

- Slope drain sections shall be securely fastened together, fused or have gasketed watertight fittings, and shall be securely anchored into the soil.



- Thrust blocks should be installed anytime 90 degree bends are utilized. Depending on size of pipe and flow, these can be constructed with sand bags, straw bales staked in place, “t” posts and wire, or ecology blocks.
- Pipe needs to be secured along its full length to prevent movement. This can be done with steel “t” posts and wire. A post is installed on each side of the pipe and the pipe is wired to them. This should be done every 10-20 feet of pipe length or so, depending on the size of the pipe and quantity of water to divert.

### Outlet

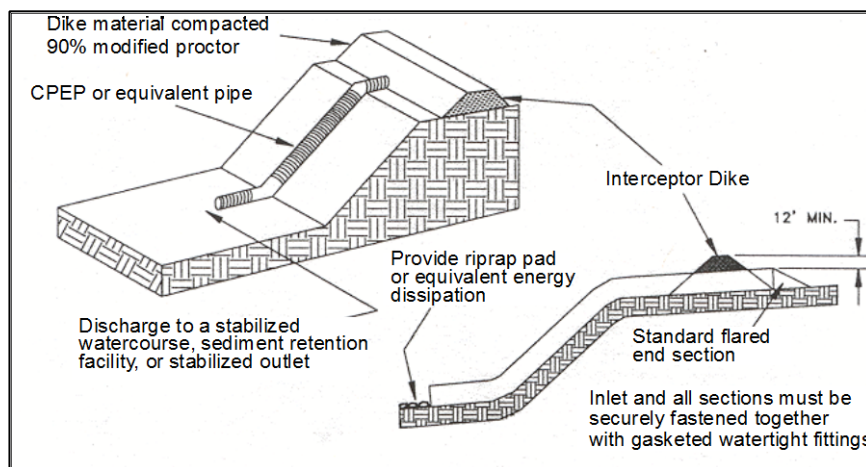
- The area below the outlet must be stabilized with a riprap apron (see [BMP C209](#), Outlet Protection, for the appropriate outlet material).

### Sediment

- If the pipe slope drain is conveying sediment-laden water, direct all flows into the sediment trapping facility.

### Maintenance Standards

- Check inlet and outlet points regularly, especially after storms. The inlet should be free of undercutting, and no water should be going around the point of entry. If there are problems, the headwall should be reinforced with compacted earth or sand bags.
- The outlet point should be free of erosion and installed with appropriate outlet protection.
- For permanent installations, inspect pipe periodically for vandalism and physical distress such as slides and wind-throw.
- Normally the pipe slope is so steep that clogging is not a problem with smooth wall pipe, however, debris may become lodged in the pipe.



**Figure 8.15: Pipe Slope Drain**

(Source: SMMWW)

## BMP C205: Subsurface Drains

---

### Purpose and Description

Subsurface drains are used to intercept, collect, and convey groundwater to a satisfactory outlet, using a perforated pipe or conduit below the ground surface. Subsurface drains are also known as “French drains.” The perforated pipe provides a dewatering mechanism to drain excessively wet soils, provides a stable base for construction, improves stability of structures with shallow foundations, or reduces hydrostatic pressure to improve slope stability.

### Conditions of Use

Use when excessive water must be removed from the soil. The soil permeability, depth to water table and impervious layers are all factors which may govern the use of subsurface drains.

### Design Criteria

#### Relief Drains

Relief drains are used either to lower the water table in large, relatively flat areas, improve the growth of vegetation, or to remove surface water.

Relief drains are installed along a slope and drain in the direction of the slope.

They can be installed in a grid pattern, a herringbone pattern, or a random pattern.

#### Interceptor Drains

Interceptor drains are used to remove excess groundwater from a slope, stabilize steep slopes, and lower the water table immediately below a slope to prevent the soil from becoming saturated.

Interceptor drains are installed perpendicular to a slope and drain to the side of the slope.

They usually consist of a single pipe or series of single pipes instead of a patterned layout.

#### Depth and Spacing

- The depth of an interceptor drain is determined primarily by the depth to which the water table is to be lowered or the depth to a confining layer. For practical reasons, the maximum depth is usually limited to 6 feet, with a minimum cover of 2 feet to protect the conduit.
- The soil should have depth and sufficient permeability to permit installation of an effective drainage system at a depth of 2 to 6 feet.
- An adequate outlet for the drainage system must be available either by gravity or by pumping.

- The quantity and quality of discharge needs to be accounted for in the receiving stream (additional detention may be required).
- This standard does not apply to subsurface drains for building foundations or deep excavations.

### Size and Capacity

- The capacity of an interceptor drain is determined by calculating the maximum rate of groundwater flow to be intercepted. Therefore, it is good practice to make complete subsurface investigations, including hydraulic conductivity of the soil, before designing a subsurface drainage system.
- Size subsurface drains to carry the required capacity without pressure flow. Minimum diameter for a subsurface drain is 4 inches.
- The minimum velocity required to prevent silting is 1.4 ft./sec. The line shall be graded to achieve this velocity at a minimum. The maximum allowable velocity using a sand-gravel filter or envelope is 9 ft/sec.
- Filter material and fabric shall be used around all drains for proper bedding and filtration of fine materials. Envelopes and filters should surround the drain to a minimum of 3-inch thickness.
- The outlet of the subsurface drain shall empty into a sediment pond through a catch basin. If free of sediment, it can then empty into a receiving channel, swale, or stable vegetated area adequately protected from erosion and undermining.
- The trench shall be constructed on a continuous grade with no reverse grades or low spots.
- Soft or yielding soils under the drain shall be stabilized with gravel or other suitable material.
- Backfilling shall be done immediately after placement of the pipe. No sections of pipe shall remain uncovered overnight or during a rainstorm. Backfill material shall be placed in the trench in such a manner that the drain pipe is not displaced or damaged.
- Do not install permanent drains near trees to avoid the tree roots that tend to clog the line. Use solid pipe with watertight connections where it is necessary to pass a subsurface drainage system through a stand of trees.
- **Outlet**--Ensure that the outlet of a drain empties into a channel or other watercourse above the normal water level.
- Secure an animal guard to the outlet end of the pipe to keep out rodents.
- Use outlet pipe of corrugated metal, cast iron, or heavy-duty plastic without perforations and at least 10 feet long. Do not use an envelope or filter material around the outlet pipe, and bury at least two-thirds of the pipe length.
- When outlet velocities exceed those allowable for the receiving stream, outlet protection must be provided.

## Maintenance Standards

Subsurface drains shall be checked periodically to ensure that they are free-flowing and not clogged with sediment or roots.

- The outlet shall be kept clean and free of debris.
- Surface inlets shall be kept open and free of sediment and other debris.
- Trees located too close to a subsurface drain often clog the system with their roots. If a drain becomes clogged, relocate the drain or remove the trees as a last resort. Drain placement should be planned to minimize this problem.
- Where drains are crossed by heavy vehicles, the line shall be checked to ensure that it is not crushed.

## BMP C206: Level Spreader

---

### Purpose and Description

Level spreaders convert concentrated runoff to sheet flow and release it onto areas stabilized by existing vegetation or an engineered filter strip.

### Conditions of Use

Used when a concentrated flow of water needs to be dispersed over a large area with existing stable vegetation.

Items to consider are:

- Will the discharge point increase flow onto an adjoining property?
- What is the risk of erosion or damage if the flow may become concentrated?
- Is an easement required if discharged to adjoining property?
- Most of the flow should be as groundwater and not as surface flow.
- Is there an unstable area downstream that cannot accept additional groundwater?

Use only where the slopes are gentle, the water volume is relatively low, and the soil will adsorb most of the low flow events.

### Design Criteria

[Figure 8.16](#) and [Figure 8.17](#) provides a cross-section and a detail of a level spreader.

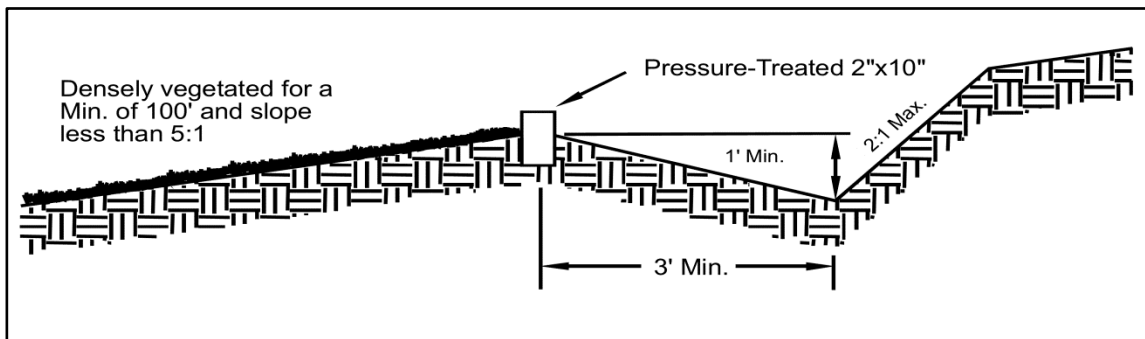
- There must be 100 feet of densely vegetated, shallow slope downstream of the level spreader.
- Discharge area below the outlet must be uniform with a slope flatter than 5H:1V.
- Outlet to be constructed level in a stable, undisturbed soil profile (not on fill).
- The runoff shall not re-concentrate after release unless intercepted by another downstream measure.
- The grade of the channel for the last 20 feet of the dike or interceptor entering the level spreader shall be less than or equal to 1 percent. The grade of the level spreader shall be 0 percent to ensure uniform spreading of storm runoff.
- A 6-inch high gravel berm placed across the level lip shall consist of washed crushed rock, 2- to 4-inch or 3/4-inch to 1½-inch size.
- The spreader length shall be determined by estimating the peak flow expected from the 10-year, 24-hour design storm. The length of the spreader shall be a minimum of 15 feet for 0.1 cfs and shall increase by 10 feet for each 0.1 cfs thereafter to a maximum of 0.5 cfs per spreader. Use multiple spreaders for higher flows.

- The width of the spreader should be at least 6 feet.
- The depth of the spreader as measured from the lip should be at least 6 inches and it should be uniform across the entire length.
- Level spreaders shall be set back from the property line unless there is an easement for flow.
- Level spreaders, when installed every so often in grassy swales, keep the flows from concentrating. Materials that can be used include sand bags, lumber, logs, concrete, pipe, and capped perforated pipe. To function properly, the material needs to be installed level and on contour

## Maintenance Standards

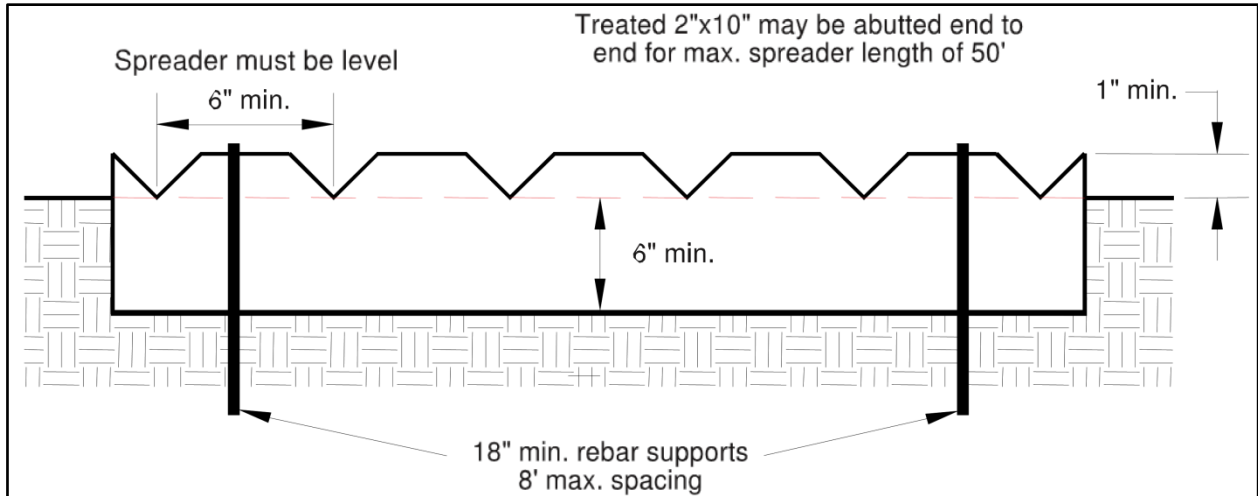
The spreader should be inspected after every runoff event to ensure that it is functioning correctly.

- Do not place any material on the structure.
- Do not allow construction traffic from crossing over the structure.
- If the spreader is damaged by construction traffic, it shall be immediately repaired.



**Figure 8.16: Level Spreader Cross-section**

(Source: SMMWW)



**Figure 8.17: Detail of a Level Spreader**

(Source: SMMWW)

## BMP C207: Check Dams

---

### Purpose and Description

Small dams across a swale or ditch reduce the velocity of concentrated flow and dissipate energy at the check dam.

### Conditions of Use

Where temporary channels or permanent channels are not yet vegetated, channel lining is infeasible, and/or velocity checks are required.

Note: Placement of check dams in receiving waters and wetlands may require approval from Washington State Department of Fish and Wildlife or other state and federal permitting agency.

This BMP has products approved as equivalent by Ecology. See [Book 1, Section 6.5.1](#).

### Design Criteria

See WSDOT Standard Detail 1-50.20-01 for a typical rock check dam.

### Placement

- Do not place check dams below the expected backwater from any salmonid bearing water between October 1 and May 31 to ensure that there is no loss of high flow refuge habitat for overwintering juvenile salmonids and emergent salmonid fry.
- Place check dams perpendicular to the flow of water.
- The maximum spacing between the dams shall be such that the toe of the upstream dam is at the same elevation as the top of the downstream dam.

### Materials

- Construct rock check dams from appropriately sized rock. The rock used must be large enough to stay in place given the expected design flow through the channel. The rock must be placed by hand or by mechanical means (no dumping of rock to form dam) to achieve complete coverage of the ditch or swale and to ensure that the center of the dam is lower than the edges.
- Check dams may also be constructed of either rock or pea-gravel filled bags. Numerous new products are also available for this purpose. They tend to be re-usable, quick and easy to install, effective, and cost efficient.

### Shape and Size

- The dam should form a triangle when viewed from the side. This prevents undercutting as water flows over the face of the dam rather than falling directly onto the ditch bottom.



- Keep the maximum height at 2 feet at the center of the dam.
- Keep the center of the check dam at least 12 inches lower than the outer edges at natural ground elevation.
- Keep the side slopes of the check dam at 2H:1V or flatter.

### Installation

- Before installing check dams impound and bypass upstream water flow away from the work area. Options for bypassing include pumps, siphons, or temporary channels.
- Check dams in association with sumps work more effectively at slowing flow and retaining sediment than just a check dam alone. A deep sump should be provided immediately upstream of the check dam.
- Key the stone into the ditch banks and extend it beyond the abutments a minimum of 18 inches to avoid washouts from overflow around the dam.
- In some cases, if carefully located and designed, check dams can remain as permanent installations with very minor regrading. They may be left as either spillways, in which case accumulated sediment would be graded and seeded, or as check dams to prevent further sediment from leaving the site.
- Use filter fabric foundation under a rock or sand bag check dam. If a blanket ditch liner is used, filter fabric is not necessary. A piece of organic or synthetic blanket cut to fit will also work for this purpose.
- Ensure that channel appurtenances, such as culvert entrances below check dams, are not subject to damage or blockage from displaced stones.

### Removal

- In the case of grass-lined ditches and swales, all check dams and accumulated sediment shall be removed when the grass has matured sufficiently to protect the ditch or swale - unless the slope of the swale is greater than 4 percent. The area beneath the check dams shall be seeded and mulched immediately after dam removal.

### Maintenance Standards

Check dams shall be monitored for performance and sediment accumulation during and after each runoff producing rainfall. Sediment shall be removed when it reaches one half the sump depth.

- Anticipate submergence and deposition above the check dam and erosion from high flows around the edges of the dam.
- If significant erosion occurs between dams, install a protective riprap liner in that portion of the channel.

## BMP C208: Triangular Silt Dike (Geotextile-Encased Check Dam)

---

### Purpose and Description

Triangular silt dikes may be used as check dams, for perimeter protection, for temporary soil stockpile protection, for drop inlet protection, or as a temporary interceptor dike.

### Conditions of Use

Triangular silt dikes may be used on soil or on pavement with adhesive or staples.

TSDs have been used to build temporary:

- sediment ponds
- diversion ditches
- concrete wash out facilities
- curbing
- water bars
- level spreaders
- berms

### Design Criteria

The triangular silt dike is made of a triangular prism of urethane foam sewn into a woven geosynthetic fabric.

### Dimensions

Height	10-14 inches high in the center
Base Width	20-28 inches
Length	7 feet (typical, but may vary)

A 2-foot apron extends beyond both sides of the triangle along its standard section of 7 feet. A sleeve at one end allows attachment of additional sections as needed.

### Installation

- Install with ends curved up to prevent water from flowing around the ends.
- The fabric flaps and check dam units are attached to the ground with wire staples. Wire staples should be No. 11 gauge wire and should be 200 mm to 300 mm in length.

- When multiple units are installed, the sleeve of fabric at the end of the unit shall overlap the abutting unit and be stapled.
- When used as check dams, the leading edge must be secured with rocks, sandbags, or a small key slot and staples.

#### Placement

- Check dams should be located and installed as soon as construction will allow.
- Check dams should be placed perpendicular to the flow of water.

#### Removal

- In the case of grass-lined ditches and swales, triangular silt dikes functioning as check dams and the accumulated sediment shall be removed when the grass has matured sufficiently to protect the ditch or swale unless the slope of the swale is greater than 4 percent. The area beneath the check dams shall be seeded and mulched immediately after dam removal.

#### Maintenance Standards

- Triangular silt dams shall be inspected for performance and sediment accumulation during and after each runoff producing rainfall. Sediment shall be removed when it reaches one half the height of the dam.
- Anticipate submergence and deposition above the triangular silt dam and erosion from high flows around the edges of the dam. Immediately repair any damage or any undercutting of the dam.

## BMP C209: Outlet Protection

---

### Purpose and Description

Outlet protection prevents scour at conveyance outlets and minimizes the potential for downstream erosion by reducing the velocity of concentrated stormwater flows.

### Conditions of Use

Outlet protection is required at the outlets of all ponds, pipes, ditches, or other conveyances, and where runoff is conveyed to a natural or manmade drainage feature such as a stream, wetland, lake, or ditch.

### Design Criteria

- New pipe outfalls can provide an opportunity for low-cost fish habitat improvements. For example, an alcove of low-velocity water can be created by constructing the pipe outfall and associated energy dissipater back from the stream edge and digging a channel, over-widened to the upstream side, from the outfall. Overwintering juvenile and migrating adult salmonids may use the alcove as shelter during high flows. Bank stabilization, bioengineering, and habitat features may be required for disturbed areas. This work may require a HPA. See [section 7.67](#) for more information on outfall system design.
- The receiving channel at the outlet of a culvert shall be protected from erosion by rock lining a minimum of 6 feet downstream and extending up the channel sides a minimum of 1-foot above the maximum tailwater elevation or 1-foot above the crown, whichever is higher. For pipes greater than 18 inches in diameter, install outlet protection lining in the channel to four times the diameter of the culvert.
- Standard wingwalls, and tapered outlets and paved channels should also be considered when appropriate for permanent culvert outlet protection. (See WSDOT Hydraulic Manual).
- Organic or synthetic erosion blankets, with or without vegetation, are usually more effective than rock, cheaper, and easier to install. Materials can be chosen using manufacturer product specifications. ASTM test results are available for most products and the designer can choose the correct material for the expected flow.
- With low flows, vegetation (including sod) can be effective.
- The following guidelines shall be used for riprap outlet protection:
  - If the discharge velocity at the outlet is less than 5 fps (pipe slope less than 1 percent), use 2-inch to 8-inch riprap. Minimum thickness is 1-foot.
  - For 5 to 10 fps discharge velocity at the outlet (pipe slope less than 3 percent), use 24-inch to 48-inch riprap. Minimum thickness is 2 feet.

- For outlets at the base of steep slope pipes (pipe slope greater than 10 percent), an engineered energy dissipater shall be used.
- Filter fabric or erosion control blankets should always be used under riprap to prevent scour and channel erosion.

### **Maintenance Standards**

- Inspect and repair as needed.
- Add rock as needed to maintain the intended function.
- Clean energy dissipater if sediment builds up.

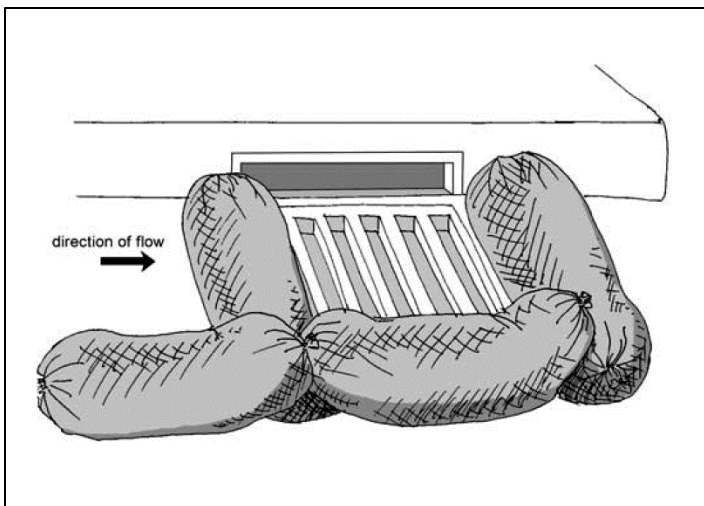
## BMP C220: Storm Drain Inlet Protection

### Purpose and Description

Storm drain inlet protection prevents coarser sediment from entering drainage systems prior to permanent stabilization of a disturbed area.

### Conditions of Use

Use storm drain inlet protection at inlets, including lawn and yard drains, that are operational before permanent stabilization of a disturbed drainage area or before gutters and conveyance are completed in new home construction. Provide protection for all storm drain inlets downslope and within 500 feet of a disturbed or construction area, unless conveying runoff entering catch basins to a sediment pond or trap.



**Figure 8.18: Illustration of Storm Drain Inlet Protection**

[Table 8.7](#) lists several options for inlet protection. All of the methods for storm drain inlet protection tend to plug and require a high frequency of maintenance. Limit drainage areas to one acre or less. Possibly provide emergency overflows with additional end-of-pipe treatment where stormwater ponding would cause a hazard.

This BMP has products approved as equivalent by Ecology. See [Book 1, Section 6.5.1](#).

**Table 8.7: Storm Drain Inlet Protection**

Storm Drain Inlet Protection			
Type of Inlet Protection	Emergency Overflow	Applicable Surfaces	Conditions of Use
<b>Drop Inlet Protection</b>			
Excavated drop inlet protection	Yes, temporary flooding will occur	Earthen	Applicable for heavy flows. Easy to maintain. Large area Requirement: 30' X 30'/acre
Block and gravel drop inlet protection	Yes	Paved or Earthen	Applicable for heavy concentrated flows. Will not pond.
Gravel and wire drop inlet protection	No		Applicable for heavy concentrated flows. Will pond. Can withstand traffic.

Catch basin filters	Yes	Paved or Earthen	Frequent maintenance required.
<b>Curb Inlet Protection</b>			
Curb inlet protection with a wooden weir	Small capacity overflow	Paved	Used for sturdy, more compact installation.
Block and gravel curb inlet protection	Yes	Paved	Sturdy, but limited filtration.
<b>Culvert Inlet Protection</b>			
Culvert inlet sediment trap			18 month expected life.

## Design Criteria

### Excavated Drop Inlet Protection

This is an excavated impoundment around the storm drain. Sediment settles out of the stormwater prior to entering the storm drain.

- Provide a depth of 1-2 ft as measured from the crest of the inlet structure.
- Slope sides of excavation no steeper than 2H:1V.
- Minimum volume of excavation is 35 cubic yards.
- Shape basin to fit site with longest dimension oriented toward the longest inflow area.
- Install provisions for draining to prevent standing water problems.
- Clear the area of all debris.
- Grade the approach to the inlet uniformly.
- Drill weep holes into the side of the inlet.
- Protect weep holes with screen wire and washed aggregate.
- Seal weep holes when removing structure and stabilizing area.
- Build a temporary dike, if necessary, to the down slope side of the structure to prevent bypass flow.

### Block and Gravel Filter

This is a barrier formed around the storm drain inlet with standard concrete blocks and gravel. See [Figure 8.22](#).

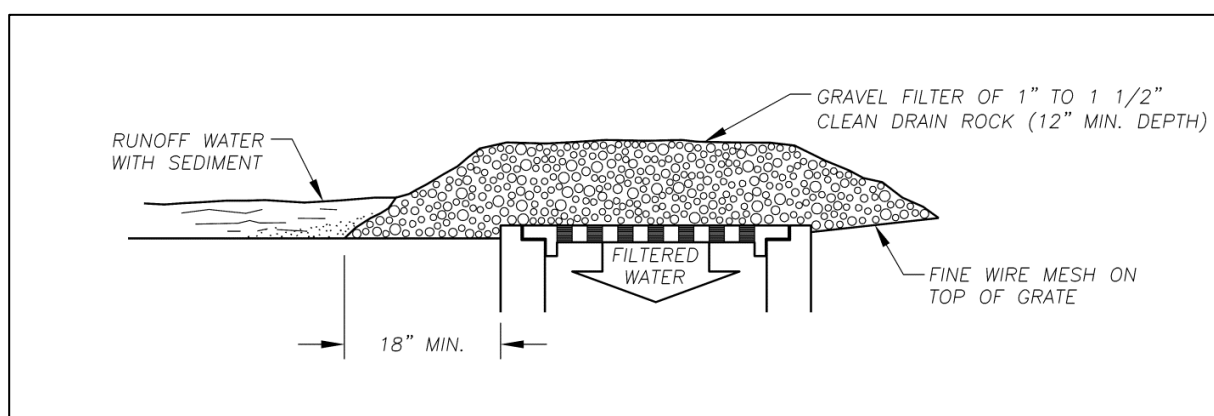
- Provide a height of 1 to 2 feet above inlet.
- Recess the first row 2-inches into the ground for stability.
- Support subsequent courses by placing a 2x4 through the block opening.

- Do not use mortar.
- Lay some blocks in the bottom row on their side for dewatering the pool.
- Place hardware cloth or comparable wire mesh with ½-inch openings over all block openings.
- Place gravel just below the top of blocks on slopes of 2H:1V or flatter.
- An alternative design is a gravel donut.
- Provide an inlet slope of 3H:1V.
- Provide an outlet slope of 2H:1V.
- Provide a 1-foot wide level stone area between the structure and the inlet.
- Use inlet slope stones 3 inches in diameter or larger.
- Use gravel ½- to ¾-inch at a minimum thickness of 1-foot for the outlet slope.

### Gravel and Wire Mesh Filter

This is a gravel barrier placed over the top of the inlet. This structure does not provide an overflow.

- Use a hardware cloth or comparable wire mesh with ½-inch openings.
- Use coarse aggregate.
- Provide a height 1-foot or more, 18-inches wider than inlet on all sides.
- Place wire mesh over the drop inlet so that the wire extends a minimum of 1-foot beyond each side of the inlet structure.
- Overlap the strips if more than one strip of mesh is necessary.
- Place coarse aggregate over the wire mesh.
- Provide at least a 12-inch depth of gravel over the entire inlet opening and extend at least 18-inches on all sides.



**Figure 8.19: Gravel and Wire Mesh Filter**

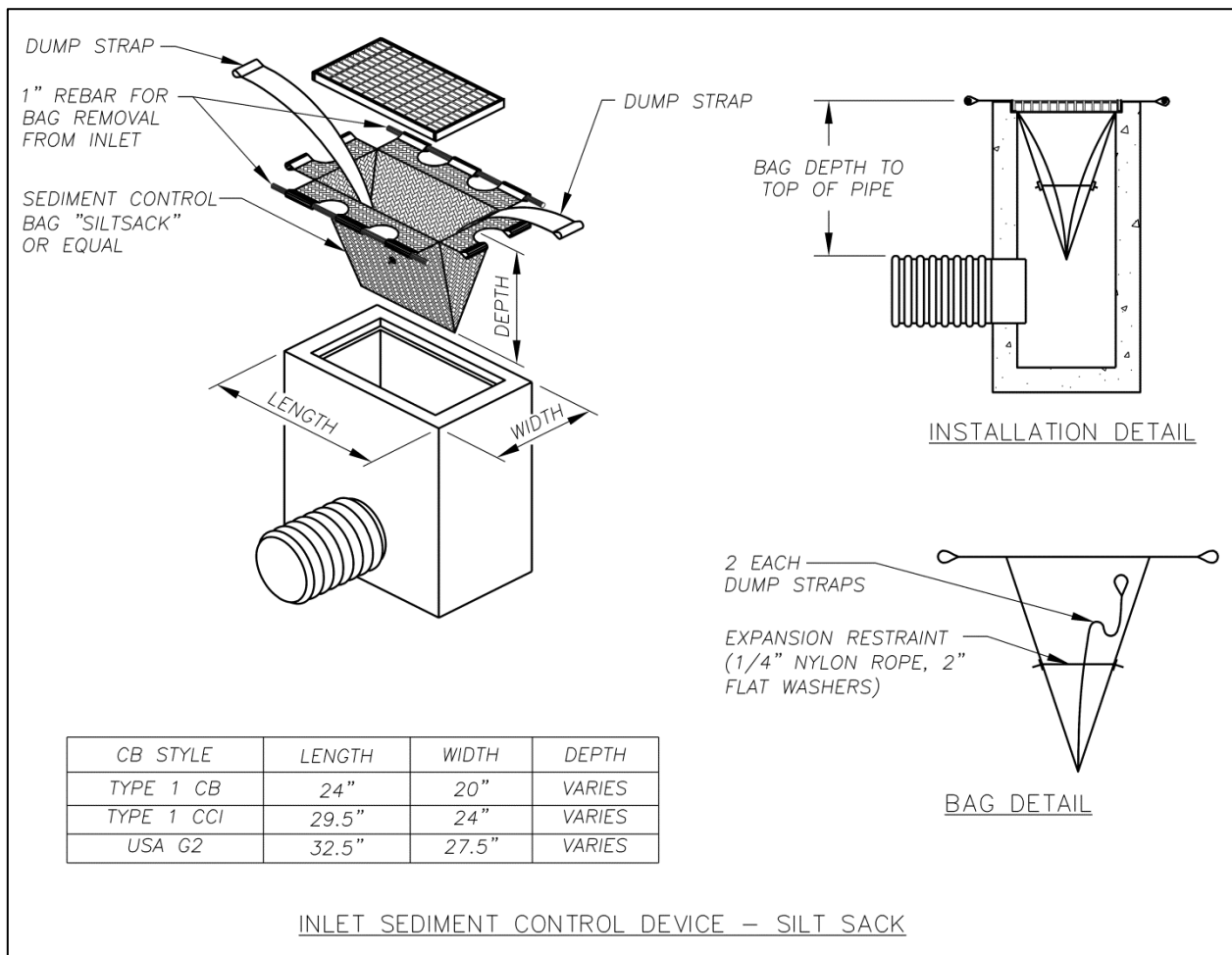
(Source: Clark County)



### Catchbasin Filters

Use inserts designed by manufacturers for construction sites. The limited sediment storage capacity increases the amount of inspection and maintenance required, which may be daily for heavy sediment loads. To reduce maintenance requirements combine a catchbasin filter with another type of inlet protection. This type of inlet protection provides flow bypass without overflow and therefore may be a better method for inlets located along active rights-of-way.

- Provides 5 cubic feet of storage.
- Requires dewatering provisions.
- Provides a high-flow bypass that will not clog under normal use at a construction site.
- Insert the catchbasin filter in the catchbasin just below the grating.



**Figure 8.20: Silt Sack Detail**

(Source: Clark County)

## Curb Inlet Protection with Wooden Weir

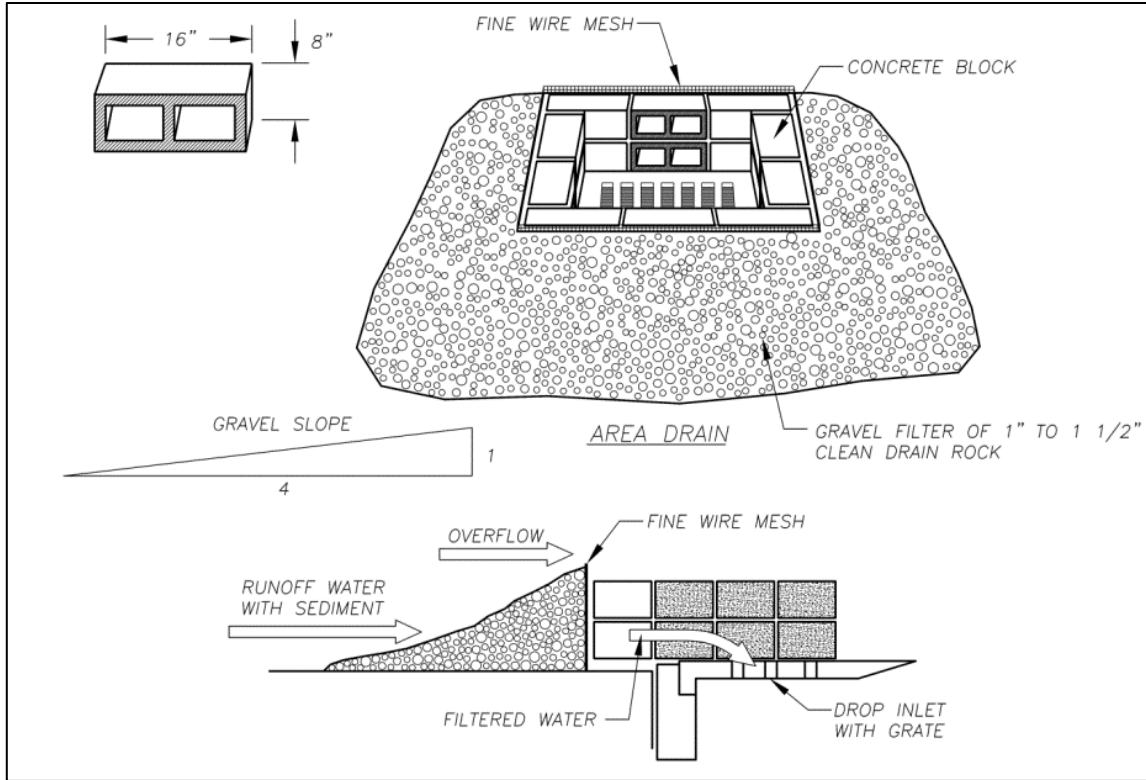
This is a barrier formed around a curb inlet with a wooden frame and gravel.

- Use wire mesh with 1/2-inch openings.
- Use extra strength filter cloth.
- Construct a frame.
- Attach the wire and filter fabric to the frame.
- Pile coarse washed aggregate against wire/fabric.
- Place weight on frame anchors.

## Block and Gravel Curb Inlet Protection

This is a barrier formed around a curb inlet with concrete blocks and gravel. Use wire mesh with 1/2-inch openings.

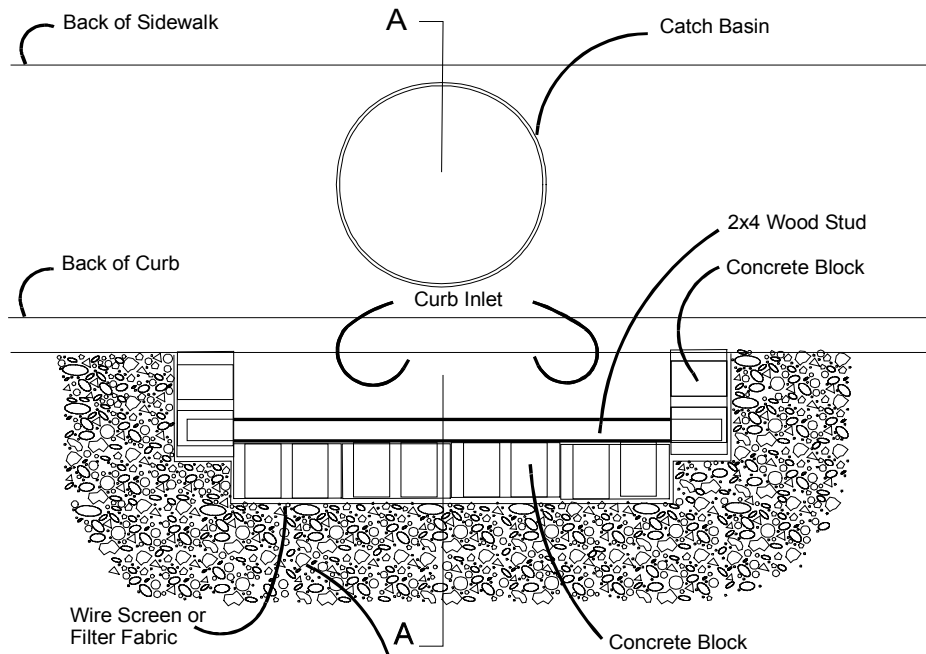
- Place two concrete blocks on their sides abutting the curb at either side of the inlet opening. These are spacer blocks.
- Place a 2x4 stud through the outer holes of each spacer block to align the front blocks.
- Place blocks on their sides across the front of the inlet and abutting the spacer blocks.
- Place wire mesh over the outside vertical face.
- Pile coarse aggregate against the wire to the top of the barrier.



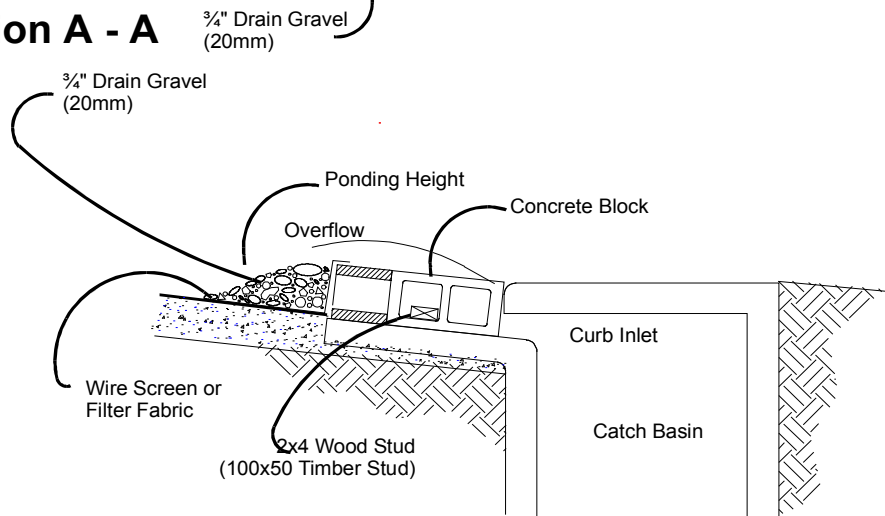
**Figure 8.21: Block and Gravel Filter for Drop Inlets**

(Source: Clark County)

## Plan View



## Section A - A



### NOTES:

1. Use block and gravel type sediment barrier when curb inlet is located in gently sloping street segment, where water can pond and allow sediment to separate from runoff.
2. Barrier shall allow for overflow from severe storm event.
3. Inspect barriers and remove sediment after each storm event. Sediment and gravel must be removed from the traveled way immediately.

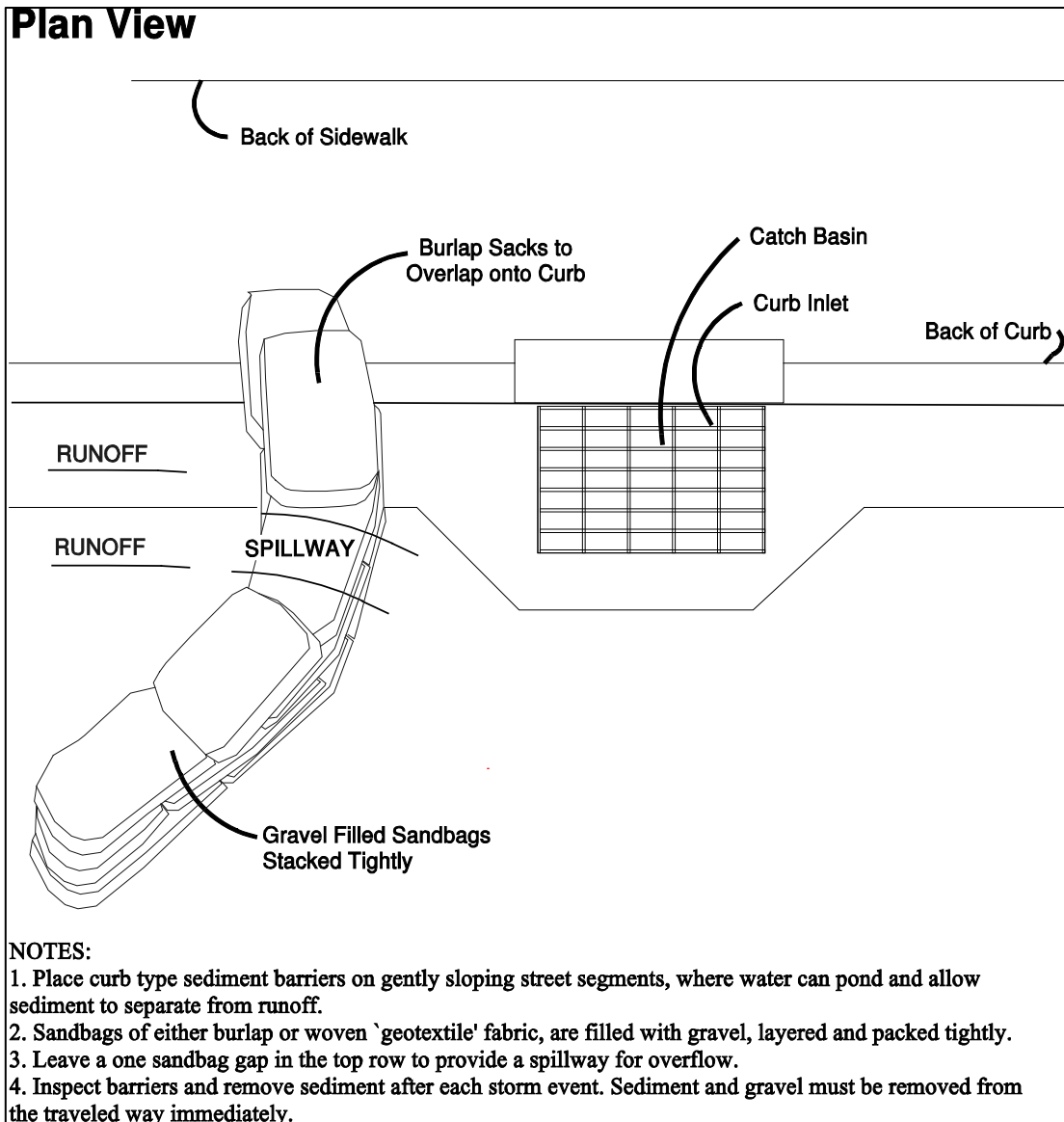
**Figure 8.22: Block and Gravel Curb Inlet Protection**

(Source: Stormwater Management Manual for Western Washington, 2014)

### Curb and Gutter Sediment Barrier

This is a sandbag or rock berm (riprap and aggregate) 3 feet high and 3 feet wide in a horseshoe shape..

- Construct a horseshoe shaped berm, faced with coarse aggregate if using riprap, 3 feet high and 3 feet wide, at least 2 feet from the inlet.
- Construct a horseshoe shaped sedimentation trap on the outside of the berm sized to sediment trap standards for protecting a culvert inlet.



**Figure 8.23: Curb and Gutter Sediment Barrier**

(Source: Stormwater Management Manual for Western Washington, 2014)

## Maintenance Standards

Inspect catch basin filters frequently, especially after storm events. Clean and replace clogged inserts. For systems with clogged stone filters: pull away the stones from the inlet and clean or replace. An alternative approach would be to use the clogged stone as fill and put fresh stone around the inlet.

Do not wash sediment into storm drains while cleaning. Spread all excavated material evenly over the surrounding land area or stockpile and stabilize as appropriate.

## BMP C231: Brush Barrier

---

### Purpose and Description

The purpose of brush barriers is to reduce the transport of coarse sediment from a construction site by providing a temporary physical barrier to sediment and reducing the runoff velocities of overland flow.

A brush barrier is a perimeter sediment control constructed of material such as small tree branches, root mats, or other debris left over from site clearing and grubbing. Brush barriers can be covered with a filter cloth to stabilize the structure and improve barrier efficiency.

### Conditions of Use

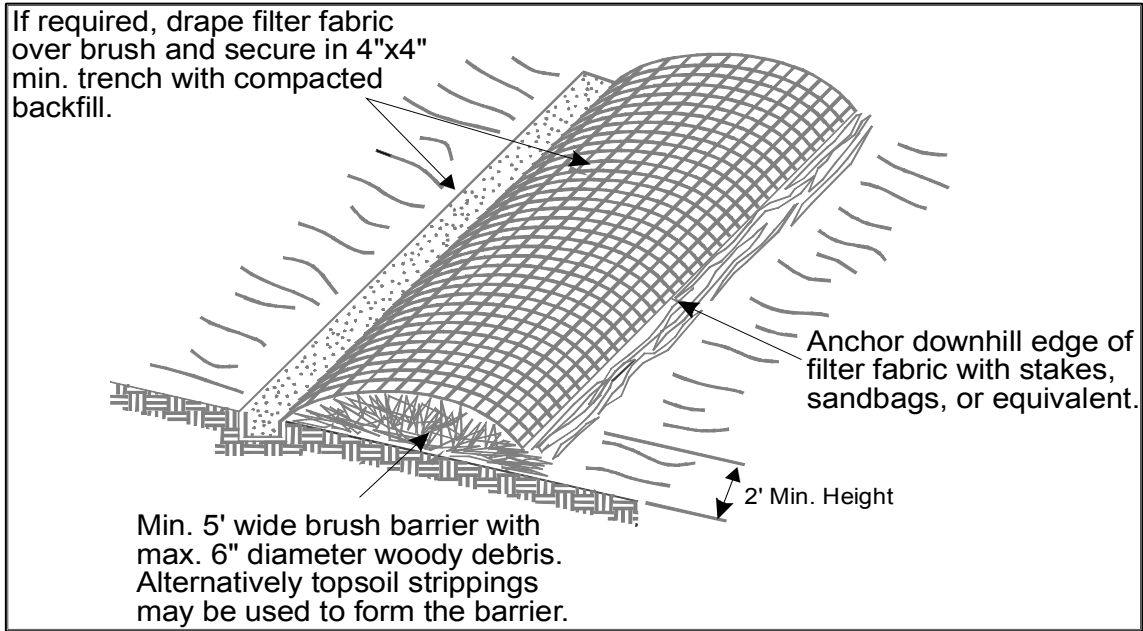
- Brush barriers may be used downslope of all disturbed areas of less than one-quarter acre.
- Brush barriers are not intended to treat concentrated flows, nor are they intended to treat substantial amounts of overland flow. Any concentrated flows must be conveyed through the drainage system to a sediment pond. The only circumstance in which overland flow can be treated solely by a brush barrier, rather than by a sediment pond, is when the area draining to the barrier is small.
- Brush barriers should only be installed on contours.

### Design Criteria

- Height 2 feet (minimum) to 5 feet (maximum).
- Width 5 feet at base (minimum) to 15 feet (maximum).
- Filter fabric (geotextile) may be anchored over the brush berm to enhance the filtration ability of the barrier. Ten-ounce burlap is an adequate alternative to filter fabric.
- Chipped site vegetation, composted mulch, or wood-based mulch (hog fuel) can be used to construct brush barriers.
- A 100 percent biodegradable installation can be constructed using 10-ounce burlap held in place by wooden stakes.

### Maintenance Standards

- There shall be no signs of erosion or concentrated runoff under or around the barrier. If concentrated flows are bypassing the barrier, it must be expanded or augmented by toed-in filter fabric.
- The dimensions of the barrier must be maintained.



**Figure 8.24: Brush Barrier**

(Source: WA State Dept. of Ecology)



## BMP C232: Gravel Filter Berm

---

### Purpose and Description

A gravel filter berm retains sediment by using a filter berm of gravel or crushed rock.

### Conditions of Use

Where a temporary measure is needed to retain sediment from rights-of-way or in traffic areas on construction sites.

### Design Criteria

- See Clark County Standard Detail E12: Filter Berm – Rock.
- Berm material shall be  $\frac{3}{4}$  to 3 inches in size, washed well-grade gravel or crushed rock with less than 5 percent fines.
- Spacing of berms:
  - Every 300 feet on slopes less than 5 percent
  - Every 200 feet on slopes between 5 percent and 10 percent
  - Every 100 feet on slopes greater than 10 percent
- Berm dimensions:
  - 1 foot high with 3H:1V side slopes
  - 8 linear feet per 1 cfs runoff based on the 10-year, 24-hour design storm

### Maintenance Standards

- Regular inspection is required. Sediment shall be removed and filter material replaced as needed.

## BMP C233: Silt Fence

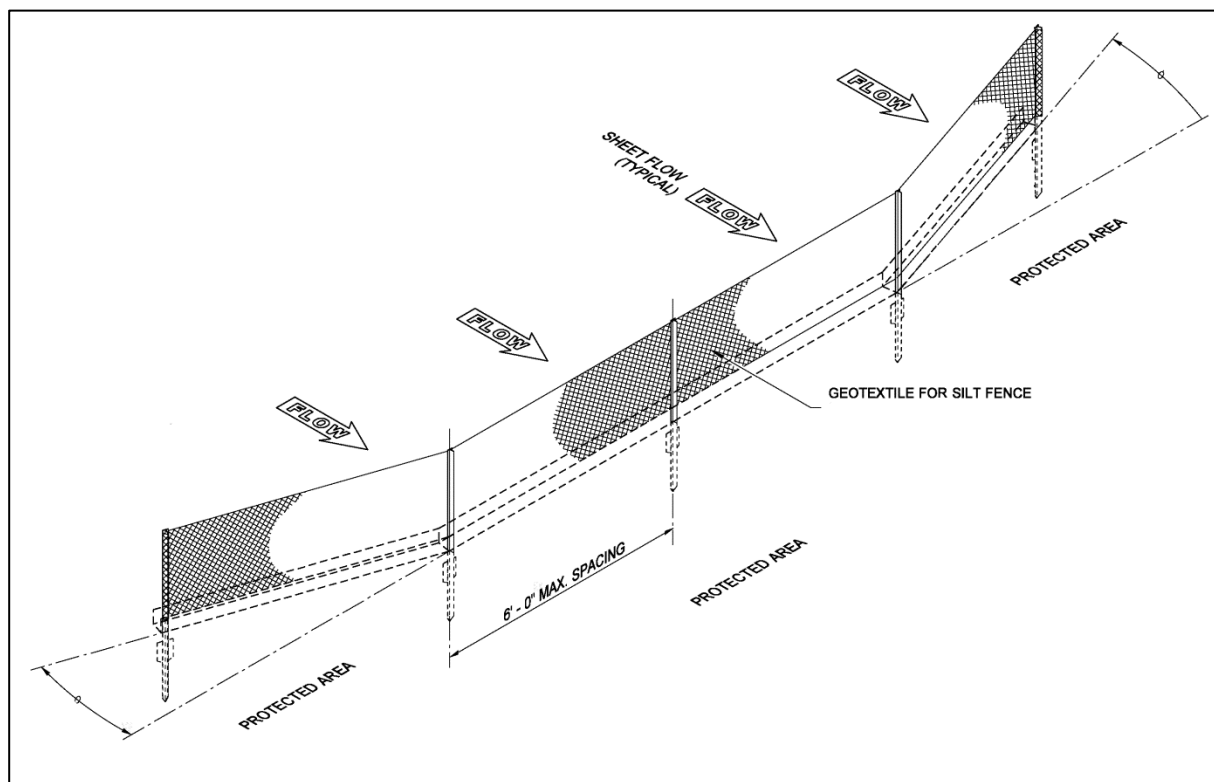
### Purpose and Description

A silt fence reduces the transport of coarse sediment from a construction site by providing a temporary physical barrier to sediment and reducing the runoff velocities of overland flow.

### Conditions of Use

Silt fence may be used downslope of all disturbed areas.

- Silt fence shall prevent soil carried by runoff water from going beneath, through, or over the top of the silt fence, but shall allow the water to pass through the fence.
- Silt fence is not intended to treat concentrated flows, nor is it intended to treat substantial amounts of overland flow. Convey any concentrated flows through the drainage system to a sediment pond.
- Do not use silt fences in streams or in V-shaped ditches.



**Figure 8.25: Silt Fence**

(Source: WSDOT Standard Plan I-30.15-02, 2013)

## Design Criteria

- Use in combination with sediment basins or other BMPs.
- Maximum slope steepness perpendicular to the fence line shall be 1H:1V.
- Maximum sheet or overland flow path length to the fence shall be 100 feet.
- Maximum flow to the silt fence shall be 0.5 cfs.
- The geotextile used shall meet the following standards. All geotextile properties listed below are minimum average roll values (i.e., the test result for any sampled roll in a lot shall meet or exceed the values shown in [Table 8.8](#)).

**Table 8.8 Geotextile Standards for Silt Fence**

<b>Geotextile Standards</b>	
Polymeric Mesh AOS (ASTM D4751)	0.60 mm maximum for slit film woven (#30 sieve). 0.30 mm maximum for all other geotextile types (#50 sieve). 0.15 mm minimum for all fabric types (#100 sieve).
Water Permittivity (ASTM D4491)	0.02 sec <sup>-1</sup> minimum
Grab Tensile Strength (ASTM D4632)	180 lbs. Minimum for extra strength fabric. 100 lbs minimum for standard strength fabric.
Grab Tensile Strength (ASTM D4632)	30% maximum
Ultraviolet Resistance (ASTM D4355)	70% minimum

- Support standard strength fabrics with wire mesh, chicken wire, 2-inch x 2-inch wire, safety fence, or jute mesh to increase the strength of the fabric. Silt fence materials are available that have synthetic mesh backing attached.
- Filter fabric material shall contain ultraviolet ray inhibitors and stabilizers to provide a minimum of six months of expected usable construction life at a temperature range of 0°F. to 120°F.
- The following Standard Notes shall be included in the construction plans and specifications:
  - The contractor shall install and maintain temporary silt fences at the locations shown in the Plans.
  - The silt fences shall be constructed in areas of clearing, grading, or drainage prior to starting those activities.
  - The silt fence shall have a 2-foot minimum and a 2½-foot maximum height above the original ground surface.
  - The filter fabric shall be sewn together at the point of manufacture to form filter fabric lengths as required. Locate all sewn seams at support posts. Alternatively, two sections

of silt fence can be overlapped, provided the Contractor can demonstrate, to the satisfaction of the Engineer, that the overlap is long enough and that the adjacent fence sections are close enough together to prevent silt laden water from escaping through the fence at the overlap.

- The filter fabric shall be attached on the up-slope side of the posts and secured with staples, wire, or in accordance with the manufacturer's recommendations, in a manner that reduces the potential for tearing.
- Support the filter fabric with wire or plastic mesh, dependent on the properties of the geotextile selected for use. If wire or plastic mesh is used, fasten the mesh securely to the up-slope side of the posts with the filter fabric up-slope of the mesh.
  - Mesh support, if used, shall consist of steel wire with a maximum mesh spacing of 2-inches, or a prefabricated polymeric mesh. The strength of the wire or polymeric mesh shall be equivalent to or greater than 180 lbs. grab tensile strength. The polymeric mesh must be as resistant to the same level of ultraviolet radiation as the filter fabric it supports.
- Bury the bottom of the filter fabric a minimum of 4 inches below the ground surface. Backfill and tamp soil in place over the buried portion of the filter fabric, so that no flow can pass beneath the fence and scouring cannot occur. When wire or polymeric back-up support mesh is used, the wire or polymeric mesh shall extend into the ground a minimum of 3 inches.
- Drive or place the fence posts into the ground a minimum depth of 18 inches, provided that a minimum depth of 12 inches is allowed if topsoil or other soft subgrade soil is not present and 18-inches cannot be reached. Fence post depth shall be increased by 6 inches if the fence is located on a slope of 3H:1V or steeper and the slope is perpendicular to the fence. If required post depths cannot be obtained, the posts shall be adequately secured by bracing or guying to prevent overturning of the fence due to sediment loading.
- Use wood, steel or equivalent posts. The spacing of the support posts shall be a maximum of 6 feet. Posts shall consist of either:
  - Wood with dimensions of 2-inches by 2-inches wide min. and a 3-foot min. length. Wood posts shall be free of defects such as knots, splits, or gouges.
  - No. 6 steel rebar or larger.
  - ASTM A 120 steel pipe with a minimum diameter of 1-inch.
  - U, T, L, or C shape steel posts with a minimum weight of 1.35 lbs./ft.
  - Other steel posts having equivalent strength and bending resistance to the post sizes listed above.

- Locate silt fences on contour as much as possible, except at the ends of the fence, where the fence shall be turned uphill such that the silt fence captures the runoff water and prevents water from flowing around the end of the fence.
- If the fence must cross contours, with the exception of the ends of the fence, place gravel check dams perpendicular to the back of the fence to minimize concentrated flow and erosion. The slope of the fence line where contours must be crossed shall not be steeper than 3H:1V.
  - Gravel check dams shall be approximately 1-foot deep at the back of the fence. Gravel check dams shall be continued perpendicular to the fence at the same elevation until the top of the check dam intercepts the ground surface behind the fence.
  - Gravel check dams shall consist of crushed surfacing base course, gravel backfill for walls, or shoulder ballast. Gravel check dams shall be located every 10 feet along the fence where the fence must cross contours.

Silt fence installation using the slicing method specifications:

- The base of both end posts must be at least 2 to 4 inches above the top of the filter fabric on the middle posts for ditch checks to drain properly. Use a hand level or string level, if necessary, to mark base points before installation.
- Install posts 3 to 4 feet apart in critical retention areas and 6 to 7 feet apart in standard applications.
- Install posts 24-inches deep on the downstream side of the silt fence, and as close as possible to the filter fabric, enabling posts to support the filter fabric from upstream water pressure.
- Install posts with the nipples facing away from the filter fabric.
- Attach the filter fabric to each post with three ties, all spaced within the top 8-inches of the filter fabric. Attach each tie diagonally 45 degrees through the filter fabric, with each puncture at least 1-inch vertically apart. Each tie should be positioned to hang on a post nipple when tightening to prevent sagging.
- Wrap approximately 6-inches of fabric around the end posts and secure with 3 ties.
- No more than 24 inches of a 36-inch filter fabric is allowed above ground level.
- Compact the soil immediately next to the filter fabric with the front wheel of the tractor, skid steer, or roller exerting at least 60 pounds per square inch. Compact the upstream side first and then each side twice for a total of four trips. Check and correct the silt fence installation for any deviation before compaction. Use a flat-bladed shovel to tuck fabric deeper into the ground if necessary.

## Maintenance Standards

- Repair any damage immediately.
- Intercept and convey all evident concentrated flows uphill of the silt fence to a sediment pond.
- Check the uphill side of the fence for signs of the fence clogging and acting as a barrier to flow and then causing channelization of flows parallel to the fence. If this occurs, replace the fence or remove the trapped sediment.
- Remove sediment deposits when the deposit reaches approximately one-third the height of the silt fence, or install a second silt fence.
- Replace filter fabric that has deteriorated due to ultraviolet breakdown

## .BMP C234: Vegetated Strip

---

### Purpose and Description

Vegetated strips reduce the transport of coarse sediment from a construction site by providing a temporary physical barrier to sediment and reducing the runoff velocities of overland flow.

### Conditions of Use

- Vegetated strips may be used downslope of all disturbed areas.
- Vegetated strips are not intended to treat concentrated flows, nor are they intended to treat substantial amounts of overland flow. Any concentrated flows must be conveyed through the drainage system to a sediment pond. The only circumstance in which overland flow can be treated solely by a strip, rather than by a sediment pond, is when the criteria in [Table 8.9](#) are met.

**Table 8.9: Contributing Drainage Area for Vegetated Strips**

<b>Contributing Drainage Area for Vegetated Strips</b>		
<b>Average Contributing area Slope</b>	<b>Average Contributing area Percent Slope</b>	<b>Max Contributing area Flow path Length</b>
1.5H:1V or flatter	67% or flatter	100 feet
2H:1V or flatter	50% or flatter	115 feet
4H:1V or flatter	25% or flatter	150 feet
6H:1V or flatter	16.7% or flatter	200 feet
10H:1V or flatter	10% or flatter	250 feet

### Design Criteria

- The vegetated strip shall consist of a minimum of a 25-foot flow path length continuous strip of dense vegetation with topsoil. Grass-covered, landscaped areas are generally not adequate because the volume of sediment overwhelms the grass. Ideally, vegetated strips shall consist of undisturbed native growth with a well-developed soil that allows for infiltration of runoff.
- The slope within the strip shall not exceed 4H:1V.
- The uphill boundary of the vegetated strip shall be delineated with clearing limits.

### Maintenance Standards

- Any areas damaged by erosion or construction activity shall be seeded immediately and protected by mulch.

- If more than 5 feet of the original vegetated strip width has had vegetation removed or is being eroded, sod must be installed.
- If there are indications that concentrated flows are traveling across the buffer, surface water controls must be installed to reduce the flows entering the buffer, or additional perimeter protection must be installed.



## BMP C235: Wattles

---

### Purpose and Description

Wattles are temporary erosion and sediment control barriers consisting of straw, compost, or other material that is wrapped in biodegradable tubular plastic or similar encasing material. They reduce the velocity and can spread the flow of rill and sheet runoff, and can capture and retain sediment. Wattles are typically 8 to 10 inches in diameter and 25 to 30 feet in length. Wattles are placed in shallow trenches and staked along the contour of disturbed or newly constructed slopes. Refer to WSDOT Standard Plan I-30.30-00 for information on Wattles (<http://www.wsdot.wa.gov/Design/Standards/>)

### Conditions of Use

Use wattles:

- In disturbed areas that require immediate erosion protection.
- On exposed soils during the period of short construction delays, or over winter months.
- On slopes requiring stabilization until permanent vegetation can be established.

Generally, wattles are effective for one to two seasons before they break down.

This BMP has products approved as equivalent by Ecology. See [Book 1, Section 6.5.1](#).

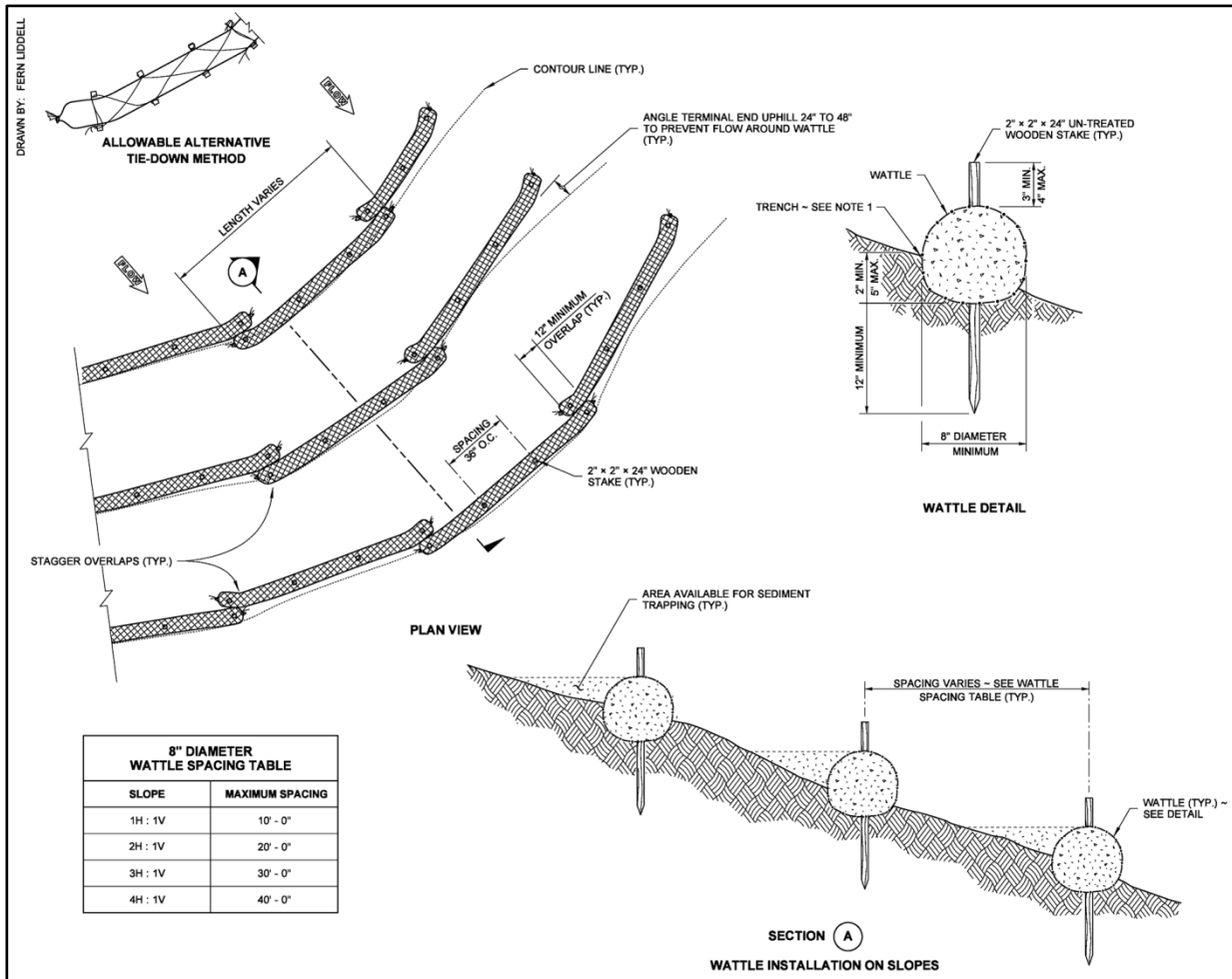
### Design Criteria

- Install wattles perpendicular to the flow direction and parallel to the slope contour.
- Dig narrow trenches across the slope on contour to a depth of 3 to 5 inches on clay soils and soils with gradual slopes. On loose soils, steep slopes, and areas with high rainfall, dig trenches to a depth of 5 to 7 inches, or 1/2 to 2/3 of the thickness of the wattle.
- Start building trenches and installing wattles from the base of the slope and work up. Spread excavated material evenly along the uphill slope and compact using hand tamping or other methods.
- Construct trenches at intervals of 10 to 25 feet depending on the steepness of the slope, soil type, and rainfall. The steeper the slope the closer together the trenches.
- Install the wattles snugly into the trenches and abut tightly end to end. Do not overlap the ends.
- Install stakes at each end of the wattle, and at 4-foot centers along entire length of wattle. Stakes should be driven through the middle of the wattle, leaving 2 to 3 inches of the stake protruding above the wattle to enable removal.
- If required, install pilot holes for the stakes using a straight bar to drive holes through the wattle and into the soil.

- Wooden stakes should have minimum dimensions of 3/4 x 3/4 x 24 inches. Willow cuttings or 3/8-inch rebar can also be used for stakes.

## Maintenance Standards

- Wattles may require maintenance to ensure they are in contact with soil and thoroughly entrenched, especially after significant rainfall on steep sandy soils.
- Inspect the slope after significant storms and repair any areas where wattles are not tightly abutted or water has scoured beneath the wattles.



**Figure 8.26: Wattles**

(Source: WSDOT standard detail I-30.30.01)

## BMP C236: Vegetative Filtration

---

### Purpose and Description

Vegetative Filtration accepts pumped collected construction stormwater, dewatering discharges, and other similar water containing sediment (often in conjunction with [BMP C241](#) Temporary Sediment Ponds and [BMP C206](#) Level Spreader) surface intake to improve turbidity levels of stormwater discharges by filtering through existing vegetation where undisturbed forest floor duff layer or established lawn with thatch layer are present. Vegetative Filtration can also be used to infiltrate dewatering waste from foundations, vaults, and trenches as long as runoff does not occur.

### Conditions of Use

Wetlands shall not be used for filtration.

Do not use this BMP in areas with a high groundwater table, or in areas that will have a high seasonal groundwater table during the use of this BMP.

### Design Criteria

- The ratio of disturbed soil area to vegetated dispersion shall be at least 5:1.
- Install a pump and downstream distribution manifold depending on the project size. Generally, the main distribution line should reach 100 to 200-feet long (many large projects, or projects on tight soil, will require systems that reach several thousand feet long with numerous branch lines off of the main distribution line).
- The manifold should have several valves, allowing for control over the distribution area in the field.
- Install several branches of 4” schedule 20, swaged-fit common septic tight-lined sewer line, or 6” fire hose, which can convey the turbid water out to various sections of the field.
- Determine the branch length based on the field area geography and number of branches. Typically, branches stretch from 200-feet to several thousand feet. Always, lay branches on contour with the slope.
- On uneven ground, sprinklers perform well. Space sprinkler heads so that spray patterns do not overlap.
- On relatively even surfaces, a level spreader using 4-inch perforated pipe may be used as an alternative option to the sprinkler head setup. Install drain pipe at the highest point on the field and at various lower elevations to ensure full coverage of the filtration area. Pipe should be placed with the holes up to allow for a gentle weeping of stormwater evenly out all holes. Leveling the pipe by staking and using sandbags may be required.
- To prevent the over saturation of the field area, rotate the use of branches or spray heads. Do this as needed based on monitoring the spray field.

- Monitor the spray field on a daily basis to ensure that over saturation of any portion of the field doesn't occur at any time. The presence of standing puddles of water or creation of concentrated flows visually signify that over saturation of the field has occurred.
- Since the operator is handling contaminated water, physically monitor the vegetated spray field all the way down to the nearest surface water, or furthest spray area, to ensure that the water has not caused overland or concentrated flows, and has not created erosion around the spray nozzle.
- Monitoring usually needs to take place 3-5 times per day to ensure sheet-flow into state waters. Do not exceed water quality standards for turbidity.
- Ecology strongly recommends that a separate inspection log be developed, maintained and kept with the existing site logbook to aid the operator conducting inspections. This separate "Field Filtration Logbook" can also aid the facility in demonstrating compliance with permit conditions.

## Maintenance Standards

- Inspect the spray nozzles daily, at a minimum, for leaks and plugging from sediment particles.
- If erosion, concentrated flows, or over saturation of the field occurs, rotate the use of branches or spray heads or move the branches to a new field location.
- Check all branches and the manifold for unintended leaks.
- Stop distributing water into the vegetated area if standing water or erosion results.

<b>Flow path Guidelines for Vegetative Filtration</b>		
<b>Average Slope</b>	<b>Average Area % Slope</b>	<b>Estimated Flow path Length (ft)</b>
1.5H:1V	67%	250
2H:1V	50%	200
4H:1V	25%	150
6H:1V	16.7%	115
10H:1V	10%	100



**Figure 8.27: Manifold and Branches in a wooded, vegetated spray field**

(Source: SMMWW)

## BMP C240: Sediment Trap

---

### Purpose and Description

A sediment trap is a small temporary ponding area with a gravel outlet used to collect and store sediment from sites cleared and/or graded during construction.

### Conditions of Use

Sediment traps, along with other perimeter controls, shall be installed before any land disturbance takes place in the drainage area.

Prior to leaving a construction site, stormwater runoff must pass through a sediment pond or trap or other appropriate sediment-removal BMP. Non-engineered sediment traps may be used on-site prior to an engineered sediment trap or sediment pond to provide additional sediment removal capacity.

A sediment trap is intended for use on sites where the tributary drainage area is less than 3 acres, with no unusual drainage features, and a projected build-out time of six months or less. The sediment trap is a temporary measure with a design life of approximately 6 months and shall be maintained until the site area is permanently protected against erosion by vegetation and/or structures.

Sediment traps and ponds are only effective in removing sediment down to about the medium silt size fraction. Runoff with sediment of finer grades (fine silt and clay) will pass through untreated, and must be either avoided or treated using another appropriate BMP.

Whenever possible, sediment-laden water shall be discharged into on-site, relatively level, vegetated areas (see [BMP C234 – Vegetated Strip](#)). This is the only way to effectively remove fine particles from runoff unless chemical treatment or filtration is used. This can be particularly useful after initial treatment in a sediment trap or pond. The areas of release must be evaluated on a site-by-site basis in order to determine appropriate locations for and methods of releasing runoff. Vegetated wetlands shall not be used for this purpose. Frequently, it may be possible to pump water from the collection point at the downhill end of the site to an upslope vegetated area. Pumping shall only augment the treatment system, not replace it, because of the possibility of pump failure or runoff volume in excess of pump capacity.

Projects that are constructing permanent facilities for runoff quantity control should use the rough-graded or final-graded permanent facilities for traps. This includes combined facilities and infiltration facilities.

Either a permanent control structure or the temporary control structure (described in [BMP C241, Temporary Sediment Pond](#)) can be used. If a permanent control structure is used, it may be advisable to partially restrict the lower orifice with gravel to increase residence time while still

allowing dewatering of the pond. A shut-off valve may be added to the control structure to allow complete retention of stormwater in emergency situations. In this case, an emergency overflow weir must be added.

A skimmer may be used for the sediment trap outlet if approved by the Responsible Official.

Sediment traps may not be feasible on utility projects due to the limited work space or the short-term nature of the work. Portable tanks may be used in place of sediment traps for utility projects.

## Design Criteria

- If permanent runoff control facilities are part of the project, they should be used for sediment retention.
- To aid in determining sediment depth, all sediment traps shall have a staff gauge with a prominent mark 1 foot above the bottom of the trap.

## Determining Trap Geometry

To determine the sediment trap geometry, first calculate the design surface area (SA) of the trap, measured at the invert of the weir. Use the following equation:

$$SA = FS(Q_2/V_s)$$

where

$Q_2$  = Design inflow based on the peak discharge from the developed 2-year runoff event from the contributing drainage area as computed in the hydrologic analysis. The 10-year peak flow shall be used if the project size, expected timing and duration of construction, or downstream conditions warrant a higher level of protection. If no hydrologic analysis is required, the Rational Method may be used.

$V_s$  = The settling velocity of the soil particle of interest. The 0.02 mm (medium silt) particle with an assumed density of 2.65 g/cm<sup>3</sup> has been selected as the particle of interest and has a settling velocity ( $V_s$ ) of 0.00096 ft/sec.

FS = A safety factor of 2 to account for non-ideal settling.

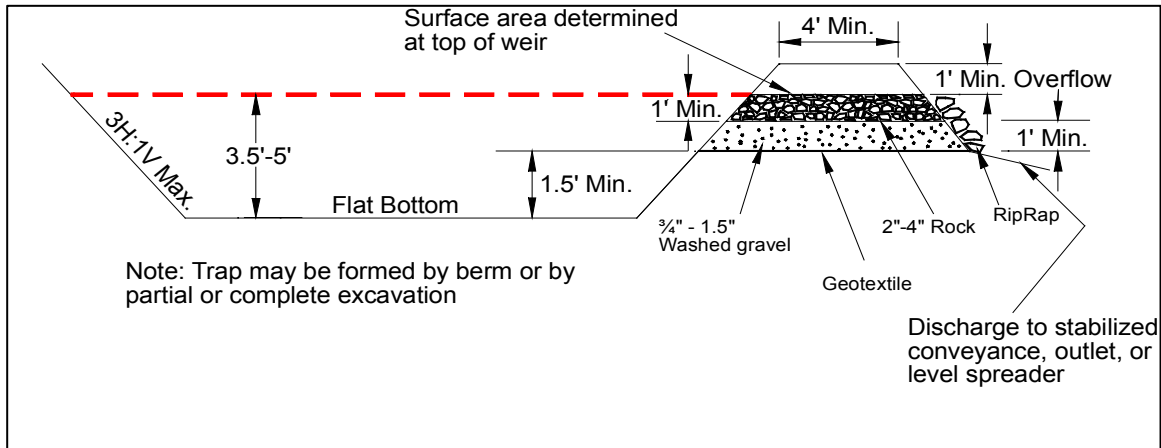
Therefore, the equation for computing surface area becomes:

$$SA = 2 \times Q_2 / 0.00096 \text{ or } 2080 \text{ square feet per cfs of inflow}$$

Note: Even if permanent facilities are used, they must have a surface area that is at least as large as that derived from the above formula. If they do not, the pond must be enlarged.

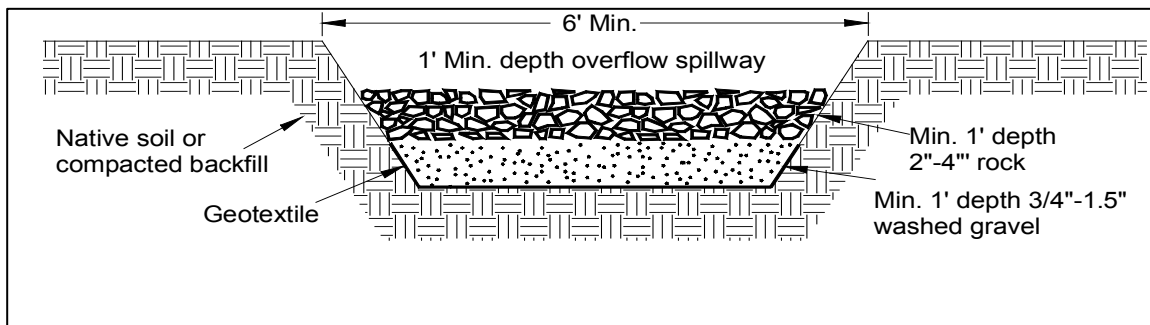
## Maintenance Standards

- Sediment shall be removed from the trap when it reaches 1 foot in depth.
- Any damage to the pond embankments or slopes shall be repaired.



**Figure 8.28: Cross-section of Sediment Trap**

(Source: WA State Dept. of Ecology)



**Figure 8.29: Sediment Trap Outlet**

(Source: WA State Dept. of Ecology)



## BMP C24I: Temporary Sediment Pond

---

### Purpose and Description

Sediment ponds remove sediment from runoff originating from disturbed areas of the site. Sediment ponds are typically designed to remove sediment no smaller than medium silt (0.02 mm). Consequently, they usually reduce turbidity only slightly.

### Conditions of Use

Prior to leaving a construction site, stormwater runoff must pass through a sediment pond or other appropriate sediment removal BMP.

A sediment pond shall be used where the contributing drainage area is 3 acres or more. Ponds must be used in conjunction with erosion control practices to reduce the amount of sediment flowing into the basin.

If permanent runoff control facilities are part of the project, they should be used for sediment retention.

### Design Criteria

- Sediment basins must be installed only on sites where failure of the structure would not result in loss of life, damage to homes or buildings, or interruption of use or service of public roads or utilities. Also, sediment traps and ponds are attractive to children and can be very dangerous. Compliance with local ordinances regarding health and safety must be addressed. If fencing of the pond is required, the type of fence and its location shall be shown on the Erosion and Sediment Control plan.
- Structures having a maximum storage capacity at the top of the dam of 10 acre-ft (435,600 ft<sup>3</sup>) or more are subject to the Washington Dam Safety Regulations ([Chapter 173-175 WAC](#)).
- If permanent runoff control facilities are being used for sediment retention, the surface area requirements of the sediment basin must be met. This may require temporarily enlarging the permanent basin to comply with the surface area requirements. The permanent control structure must be temporarily replaced with a control structure that only allows water to leave the pond from the surface or by pumping. The permanent control structure must be installed after the site is fully stabilized.
- If a future infiltration pond is used, the sides and bottom of the facility must only be rough excavated to a minimum of 2 feet above final grade. Final grading of the infiltration facility shall occur only when all contributing drainage areas are fully stabilized. The infiltration pretreatment facility should be fully constructed and used with the sedimentation basin to help prevent clogging.

## Determining Pond Geometry

- Obtain the discharge from the hydrologic calculations of the peak flow for the 2-year runoff event ( $Q_2$ ). The 10-year peak flow shall be used if the project size, expected timing and duration of construction, or downstream conditions warrant a higher level of protection. If no hydrologic analysis is required, the Rational Method may be used.

- Determine the required surface area at the top of the riser pipe with the equation:

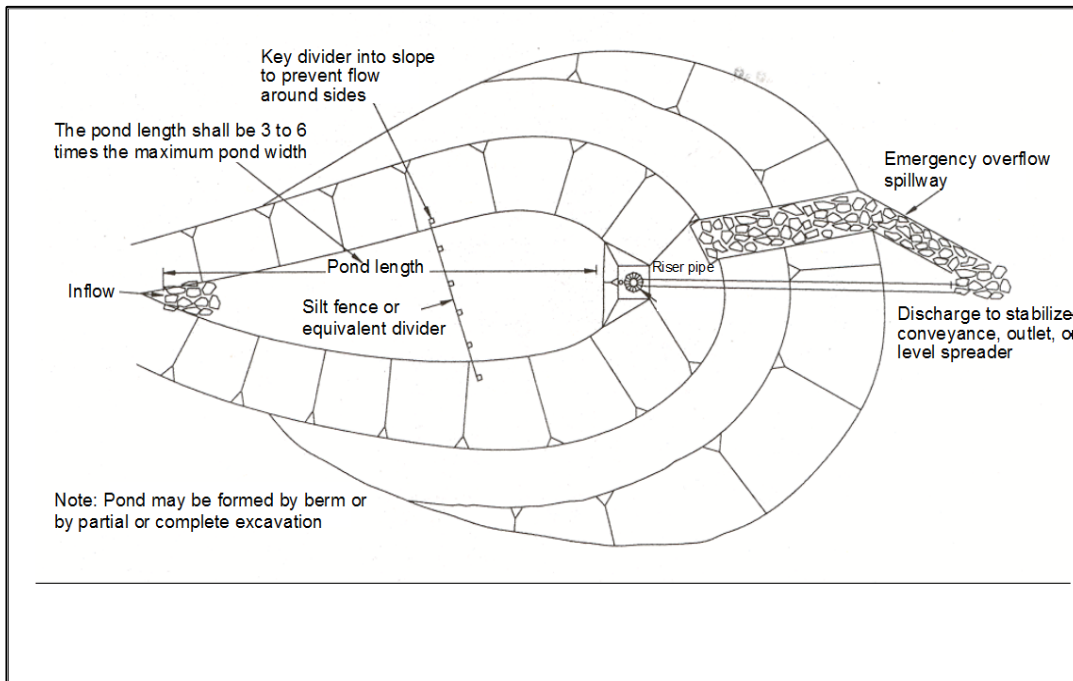
$$SA = 2 \times Q_2 / 0.00096 \quad \text{or} \quad 2080 \text{ square feet per cfs of inflow}$$

- See [BMP C240](#) for more information on the derivation of the surface area calculation.
- Now determine the basic geometry of the pond using the following design criteria:
  - Required surface area SA at top of riser.
  - Minimum 3.5-foot depth from top of riser to bottom of pond.
  - Maximum 3H:1V interior side slopes and maximum 2H:1V exterior slopes. The interior slopes can be increased to a maximum of 2H:1V if fencing is provided at or above the maximum water surface.
  - One foot of freeboard between the top of the riser and the crest of the emergency spillway.
  - Flat bottom.
  - Minimum 1-foot deep spillway.
  - Length-to-width ratio between 3:1 and 6:1.

## Sizing of Discharge Mechanisms

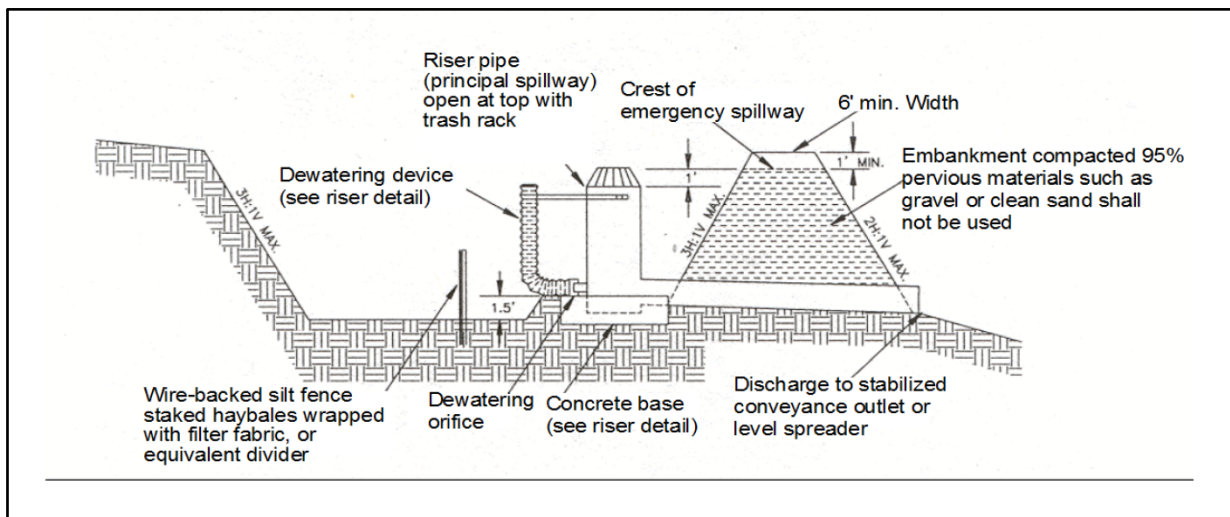
- The outlet for the basin consists of a combination of principal and emergency spillways. These outlets must pass the peak runoff expected from the contributing drainage area for a 100-year storm. If, due to site conditions and basin geometry, a separate emergency spillway is not feasible, the principal spillway must pass the entire peak runoff expected from the 100-year storm. However, an attempt to provide a separate emergency spillway should always be made. Base runoff calculations on the site conditions during construction. The flow through the dewatering orifice cannot be utilized when calculating the 100-year storm elevation because of its potential to become clogged; therefore, available spillway storage must begin at the principal spillway riser crest.
- The principal spillway designed by the procedures contained in this standard will result in some reduction in the peak rate of runoff. However, the riser outlet design will not adequately control the basin discharge to the pre-development discharge limitations as stated in Minimum Requirement #7: Flow Control. However, if the basin for a permanent stormwater detention pond is used for a temporary sedimentation basin, the control structure for the permanent pond can be used to maintain pre-development discharge limitations. The size of the basin, the expected life of the construction project, the anticipated downstream effects and the anticipated

weather conditions during construction, should be considered to determine the need of additional discharge control. See [Figure 8.31](#) for riser inflow curves.



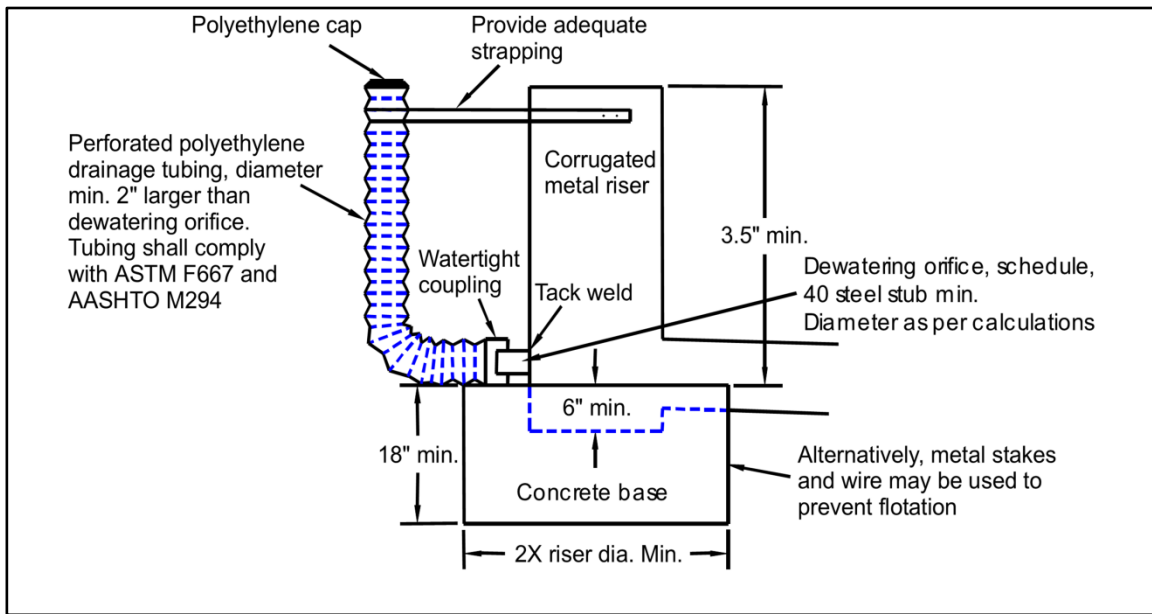
**Figure 8.30: Sediment Pond Plan View**

(Source: SMMWW)



**Figure 8.31: Temporary Sediment Pond Cross-section**

(Source: SMMWW)



**Figure 8.32: Temporary Sediment Pond Riser Detail**

(Source: SMMWW)

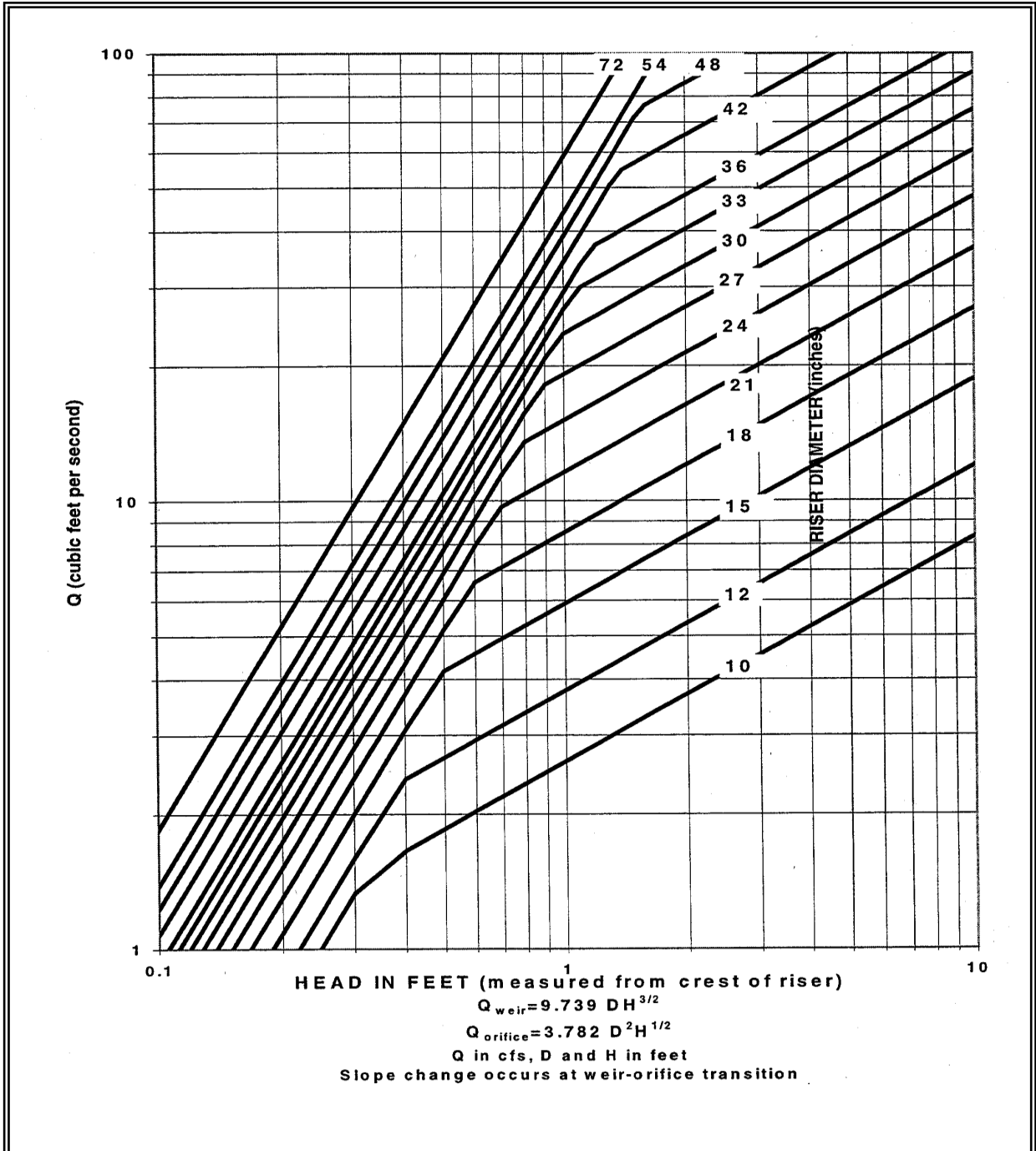


Figure 8.33: Riser Inflow Curves

(Source: SMMWW)

### Principal Spillway

Determine the required diameter for the principal spillway (riser pipe). The diameter shall be the minimum necessary to pass the site's 15-minute, 10-year flowrate. If using the Western Washington Hydrology Model (WVHM), Version 2 or 3, design flow is the 10-year (1 hour) flow for the developed (unmitigated) site, multiplied by a factor of 1.6. Use [Figure 8.31](#) to determine this diameter ( $b = 1$ -foot). *Note: A permanent control structure may be used instead of a temporary riser.*

### Emergency Overflow Spillway

Determine the required size and design of the emergency overflow spillway for the developed 100-year peak flow using the methods described for detention ponds, [BMP D6.10](#), in [Section 6.2](#).

### Dewatering Orifice

Determine the size of the dewatering orifice(s) (minimum 1-inch diameter) using a modified version of the discharge equation for a vertical orifice and a basic equation for the area of a circular orifice. Determine the required area of the orifice with the following equation:

$$A_o = \frac{A_s (2h)^{0.5}}{0.6 \times 3600 T g^{0.5}}$$

Where

- $A_o$  = orifice area (square feet)
- $A_s$  = pond surface area (square feet)
- $h$  = head of water above orifice (height of riser in feet)
- $T$  = dewatering time (24 hours)
- $g$  = acceleration of gravity (32.2 feet/second<sup>2</sup>)

Convert the required surface area to the required diameter  $D$  of the orifice:

$$D = 24 \times \sqrt{\frac{A_o}{\pi}} = 13.54 \times \sqrt{A_o}$$

The vertical, perforated tubing connected to the dewatering orifice must be at least 2 inches larger in diameter than the orifice to improve flow characteristics. The size and number of perforations in the tubing should be large enough so that the tubing does not restrict flow. The orifice should control the flow rate.

### **Additional Design Specifications**

- The pond shall be divided into two roughly equal-volume cells by a permeable divider that will reduce turbulence while allowing movement of water between cells. The divider shall be at least

one-half the height of the riser and a minimum of 1 foot below the top of the riser. Wire-backed, 2- to 3-foot high, extra strength filter fabric supported by treated 4"x4"s can be used as a divider. Alternatively, staked straw bales wrapped with filter fabric (geotextile) may be used. If the pond is more than 6 feet deep, a different mechanism must be proposed. A riprap embankment is one acceptable method of separation for deeper ponds. Other designs that satisfy the intent of this provision are allowed as long as the divider is permeable, structurally sound, and designed to prevent erosion under or around the barrier.

- To aid in determining sediment depth, 1-foot intervals shall be prominently marked on the riser.
- The most common structural failure of sedimentation basins is caused by piping. Piping refers to two phenomena: (1) water seeping through fine-grained soil, eroding the soil grain by grain and forming pipes or tunnels; and, (2) water under pressure flowing upward through a granular soil with a head of sufficient magnitude to cause soil grains to lose contact and capability for support. The most critical construction sequences to prevent piping will be:
  - Tight connections between riser and barrel and other pipe connections.
  - Adequate anchoring of riser.
  - Proper soil compaction of the embankment and riser footing.
  - Proper construction of anti-seep devices.

### Maintenance Standards

- Sediment shall be removed from the pond when it reaches 1 foot in depth.
- Any damage to the pond embankments or slopes shall be repaired immediately.

## BMP C250: Construction Stormwater Chemical Treatment

---

### Purpose and Description

This BMP applies when using stormwater chemicals in batch treatment or flow-through treatment.

Turbidity is difficult to control once fine particles are suspended in stormwater runoff from a construction site. Sedimentation ponds are effective at removing larger particulate matter by gravity settling, but are ineffective at removing smaller particulates such as clay and fine silt. Traditional erosion and sediment control BMPs may not be adequate to ensure compliance with the water quality standards for turbidity in receiving water.

Chemical treatment can reliably provide exceptional reductions of turbidity and associated pollutants. Chemical treatment may be required to meet turbidity stormwater discharge requirements, especially when construction is to proceed through the wet season.

### Conditions of Use

Formal written approval from Ecology is required for the use of chemical treatment before Clark County will approve the use of this BMP. When approved, the chemical treatment systems must be included in the Construction Stormwater Permit SWPPP.

### Design Criteria

*See the 2014 [Stormwater Management Manual for Western Washington](#), Appendix II-B, for background information on chemical treatment.*

### Criteria for Chemical Treatment Product Use

Chemically treated stormwater discharged from construction sites must be nontoxic to aquatic organisms. The Chemical Technology Assessment Protocol (CTAPE) must be used to evaluate chemicals proposed for stormwater treatment. Only chemicals approved by Ecology under the CTAPE may be used for stormwater treatment. The approved chemicals, their allowable application techniques (batch treatment or flow-through treatment), allowable application rates, and conditions of use can be found at the Department of Ecology Emerging Technologies website: <http://www.ecy.wa.gov/programs/wq/stormwater/newtech/technologies.html>.

### Treatment System Design Considerations

The design and operation of a chemical treatment system should take into consideration the factors that determine optimum, cost-effective performance. It is important to recognize the following:

- Only Ecology approved chemicals may be used and must follow approved dose rate.



- The pH of the stormwater must be in the proper range for the polymers to be effective, which is typically 6.5 to 8.5
- The coagulant must be mixed rapidly into the water to ensure proper dispersion.
- A flocculation step is important to increase the rate of settling, to produce the lowest turbidity, and to keep the dosage rate as low as possible.
- Too little energy input into the water during the flocculation phase results in flocs that are too small and/or insufficiently dense. Too much energy can rapidly destroy floc as it is formed.
- Care must be taken in the design of the withdrawal system to minimize outflow velocities and to prevent floc discharge. Discharge from a batch treatment system should be directed through a physical filter such as a vegetated swale that would catch any unintended floc discharge. Currently, flow-through systems always discharge through the chemically enhanced sand filtration system.
- System discharge rates must take into account downstream conveyance integrity.

### Polymer Batch Treatment Process Description

A batch chemical treatment system consists of the stormwater collection system (either temporary diversion or the permanent site drainage system), a storage pond, pumps, a chemical feed system, treatment cells, and interconnecting piping.

The batch treatment system shall use a minimum of two lined treatment cells in addition to an untreated stormwater storage pond. Multiple treatment cells allow for clarification of treated water while other cells are being filled or emptied. Treatment cells may be ponds or tanks. Ponds with constructed earthen embankments greater than six feet high or which impound more than 10 acre-feet require special engineering analyses. The Ecology Dam Safety Section has specific design criteria for dams in Washington State (see <http://www.ecy.wa.gov/programs/wr/dams/GuidanceDocs.html>).

Stormwater is collected at interception point(s) on the site and is diverted by gravity or by pumping to an untreated stormwater storage pond or other untreated stormwater holding area. The stormwater is stored until treatment occurs. It is important that the holding pond be large enough to provide adequate storage.

The first step in the treatment sequence is to check the pH of the stormwater in the untreated stormwater storage pond. The pH is adjusted by the application of carbon dioxide or a base until the stormwater in the storage pond is within the desired pH range, 6.5 to 8.5. When used, carbon dioxide is added immediately downstream of the transfer pump. Typically sodium bicarbonate (baking soda) is used as a base, although other bases may be used. When needed, base is added directly to the untreated stormwater storage pond. The stormwater is recirculated with the treatment pump to provide mixing in the storage pond. Initial pH adjustments should be based on daily bench tests. Further pH adjustments can be made at any point in the process.

Once the stormwater is within the desired pH range (dependent on polymer being used), the stormwater is pumped from the untreated stormwater storage pond to a treatment cell as polymer is added. The polymer is added upstream of the pump to facilitate rapid mixing.

After polymer addition, the water is kept in a lined treatment cell for clarification of the sediment-floc. In a batch mode process, clarification typically takes from 30 minutes to several hours. Prior to discharge samples are withdrawn for analysis of pH, flocculent chemical concentration, and turbidity. If both are acceptable, the treated water is discharged.

Several configurations have been developed to withdraw treated water from the treatment cell. The original configuration is a device that withdraws the treated water from just beneath the water surface using a float with adjustable struts that prevent the float from settling on the cell bottom. This reduces the possibility of picking up sediment-floc from the bottom of the pond. The struts are usually set at a minimum clearance of about 12 inches; that is, the float will come within 12 inches of the bottom of the cell. Other systems have used vertical guides or cables which constrain the float, allowing it to drift up and down with the water level. More recent designs have an H-shaped array of pipes, set on the horizontal.

This scheme provides for withdrawal from four points rather than one. This configuration reduces the likelihood of sucking settled solids from the bottom. It also reduces the tendency for a vortex to form. Inlet diffusers, a long floating or fixed pipe with many small holes in it, are also an option.

Safety is a primary concern. Design should consider the hazards associated with operations, such as sampling. Facilities should be designed to reduce slip hazards and drowning. Tanks and ponds should have life rings, ladders, or steps extending from the bottom to the top.

### **Polymer Batch Treatment Process Description**

At a minimum, a flow-through chemical treatment system consists of the stormwater collection system (either temporary diversion or the permanent site drainage system), an untreated stormwater storage pond, and the chemically enhanced sand filtration system.

Stormwater is collected at interception point(s) on the site and is diverted by gravity or by pumping to an untreated stormwater storage pond or other untreated stormwater holding area. The stormwater is stored until treatment occurs. It is important that the holding pond be large enough to provide adequate storage.

Stormwater is then pumped from the untreated stormwater storage pond to the chemically enhanced sand filtration system where polymer is added. Adjustments to pH may be necessary before chemical addition. The sand filtration system continually monitors the stormwater for turbidity and pH. If the discharge water is ever out of an acceptable range for turbidity or pH, the water is recycled to the untreated stormwater pond where it can be retreated.

For batch treatment and flow-through treatment, the following equipment should be located in a lockable shed:

- The chemical injector.
- Secondary containment for acid, caustic, buffering compound, and treatment chemical.
- Emergency shower and eyewash.
- Monitoring equipment which consists of a pH meter and a turbidimeter.

#### System Sizing:

Certain sites are required to implement flow control for the developed sites. These sites must also control stormwater release rates during construction. Generally, these are sites that discharge stormwater directly, or indirectly, through a conveyance system, into a fresh water. System sizing is dependent on flow control requirements.

#### *Sizing Criteria for Batch Treatment Systems for Flow Control Exempt Water Bodies:*

The total volume of the untreated stormwater storage pond and treatment ponds or tanks must be large enough to treat stormwater that is produced during multiple day storm events. It is recommended that at a minimum the untreated stormwater storage pond be sized to hold 1.5 times the runoff volume of the 10-year, 24-hour storm event. Bypass should be provided around the chemical treatment system to accommodate extreme storm events. Runoff volume shall be calculated using the methods presented in [Chapter 1](#). Worst-case land cover conditions (i.e., producing the most runoff) should be used for analyses (in most cases, this would be the land cover conditions just prior to final landscaping).

Primary settling should be encouraged in the untreated stormwater storage pond. A forebay with access for maintenance may be beneficial.

There are two opposing considerations in sizing the treatment cells. A larger cell is able to treat a larger volume of water each time a batch is processed. However, the larger the cell the longer the time required to empty the cell. A larger cell may also be less effective at flocculation and therefore require a longer settling time. The simplest approach to sizing the treatment cell is to multiply the allowable discharge flow rate times the desired drawdown time. A 4-hour drawdown time allows one batch per cell per 8-hour work period, given 1 hour of flocculation followed by two hours of settling.

If the discharge is directly to a flow control exempt receiving water listed in [Section 1.2.3 of Book 1](#) or to an infiltration system, there is no discharge flow limit.

Ponds sized for flow control water bodies must at a minimum meet the sizing criteria for flow control exempt waters.

### *Sizing Criteria for Flow-Through Treatment Systems for Flow Control Exempt Water Bodies:*

When sizing storage ponds or tanks for flow-through systems for flow control exempt water bodies, the treatment system capacity should be a factor. The untreated stormwater storage pond or tank should be sized to hold 1.5 times the runoff volume of the 10-year, 24-hour storm event minus the treatment system flowrate for an 8-hour period. For a chitosan-enhanced sand filtration system, the treatment system flowrate should be sized using a hydraulic loading rate between 6-8 gpm/ft<sup>2</sup>. Other hydraulic loading rates may be more appropriate for other systems. Bypass should be provided around the chemical treatment system to accommodate extreme storms. Runoff volume shall be calculated using the methods presented in [Chapter 1](#). Worst-case land cover conditions (i.e., producing the most runoff) should be used for analyses (in most cases, this would be the land cover conditions just prior to final landscaping).

### *Sizing Criteria for Flow Control Water Bodies:*

Sites that must implement flow control for the developed site condition must also control stormwater release rates during construction. Construction site stormwater discharges shall not exceed the discharge durations of the pre-developed condition for the range of pre-developed discharge rates from ½ of the 2-year flow through the 10-year flow as predicted by an approved continuous flow model. The pre-developed condition to be matched shall be the land cover condition immediately prior to the development project. This restriction on release rates can affect the size of the storage pond and treatment cells.

The following is how WWHM can be used to determine the release rates from the chemical treatment systems:

1. Determine the pre-developed flow durations to be matched by entering the existing land use area under the “Pre-developed” scenario in WWHM. The default flow range is from ½ of the 2-year flow through the 10-year flow.
2. Enter the post developed land use area in the “Developed Unmitigated” scenario in WWHM.
3. Copy the land use information from the “Developed Unmitigated” to “Developed Mitigated” scenario.
4. While in the “Developed Mitigated” scenario, add a pond element under the basin element containing the post-developed land use areas. This pond element represents information on the available untreated stormwater storage and discharge from the chemical treatment system. In cases where the discharge from the chemical treatment system is controlled by a pump, a stage/storage/discharge (SSD) table representing the pond must be generated outside WWHM and imported into WWHM. WWHM can route the runoff from the post-developed condition through this SSD table (the pond) and determine compliance with the flow duration standard. This would be an iterative design procedure where if the initial SSD table proved to be inadequate, the designer would have to modify the SSD table outside WWHM and re-import in

WWHM and route the runoff through it again. The iteration will continue until a pond that complies with the flow duration standard is correctly sized.

Notes on SSD table characteristics:

- The pump discharge rate would likely be initially set at just below  $\frac{1}{2}$  of the 2-year flow from the pre-developed condition. As runoff coming into the untreated stormwater storage pond increases and the available untreated stormwater storage volume gets used up, it would be necessary to increase the pump discharge rate above  $\frac{1}{2}$  of the 2-year. The increase(s) above  $\frac{1}{2}$  of the 2-year must be such that they provide some relief to the untreated stormwater storage needs but at the same time will not cause violations of the flow duration standard at the higher flows. The final design SSD table will identify the appropriate pumping rates and the corresponding stage and storages.
  - When building such a flow control system, the design must ensure that any automatic adjustments to the pumping rates will be as a result of changes to the available storage in accordance with the final design SSD table.
5. It should be noted that the above procedures would be used to meet the flow control requirements. The chemical treatment system must be able to meet the runoff treatment requirements. It is likely that the discharge flow rate of  $\frac{1}{2}$  of the 2-year or more may exceed the treatment capacity of the system. If that is the case, the untreated stormwater discharge rate(s) (i.e., influent to the treatment system) must be reduced to allow proper treatment. Any reduction in the flows would likely result in the need for a larger untreated stormwater storage volume.
6. If the discharge is to a municipal storm drainage system, the allowable discharge rate may be limited by the capacity of the public system. It may be necessary to clean the municipal storm drainage system prior to the start of the discharge to prevent scouring solids from the drainage system. If the municipal storm drainage system discharges to a water body not on the flow control exempt list, the project site is subject to flow control requirements. Obtain permission from the owner of the collection system before discharging to it.

If system design does not allow discharging at the slower rates as described above and if the site has a retention or detention pond that will serve the planned development, the discharge from the treatment system may be directed to the permanent retention/detention pond to comply with the flow control requirement. In this case, the untreated stormwater storage pond and treatment system will be sized according to the sizing criteria for flow-through treatment systems for flow control exempt water bodies described earlier except all discharge (water passing through the treatment system and stormwater bypassing the treatment system) will be directed into the permanent retention/detention pond. If site constraints make locating the untreated stormwater storage pond difficult, the permanent retention/detention pond may be divided to serve as the untreated stormwater storage pond and the post-treatment flow control pond. A berm or barrier must be used in this case so the untreated water does not mix with the treated water. Both untreated stormwater storage requirements, and adequate post-treatment flow control must be achieved. The post-

treatment flow control pond's revised dimensions must be entered into the WWHM and the WWHM must be run to confirm compliance with the flow control requirement.

## Maintenance Standards

### Monitoring

At a minimum, the following monitoring shall be conducted. Test results shall be recorded on a daily log kept on site. Additional testing may be required by the NPDES permit based on site conditions.

#### Operational Monitoring

- Total volume treated and discharged.
- Flow must be continuously monitored and recorded at not greater than 15-minute intervals.
- Type and amount of chemical used for pH adjustment.
- Amount of polymer used for treatment.
- Settling time.

#### Compliance Monitoring

- Influent and effluent pH, flocculent chemical concentration, and turbidity must be continuously monitored and recorded at not greater than 15-minute intervals. pH and turbidity of the receiving water.

#### Biomonitoring

Treated stormwater must be non-toxic to aquatic organisms. Treated stormwater must be tested for aquatic toxicity or residual chemicals. Frequency of biomonitoring will be determined by Ecology.

Residual chemical tests must be approved by Ecology prior to their use.

If testing treated stormwater for aquatic toxicity, the testing must include acute (lethal) toxicity. Bioassays shall be conducted by a laboratory accredited by Ecology, unless otherwise approved by Ecology. Acute toxicity tests shall be conducted per the CTAPE protocol.

### Discharge Compliance

Prior to discharge, treated stormwater must be sampled and tested for compliance with pH, flocculent chemical concentration, and turbidity limits. These limits may be established by the Construction Stormwater General Permit or a site-specific discharge permit. Sampling and testing for other pollutants may also be necessary at some sites. pH must be within the range of 6.5 to 8.5 standard units and not cause a change in the pH of the receiving water of more than 0.2 standard units. Treated stormwater samples and measurements shall be taken from the discharge pipe or another location representative of the nature of the treated stormwater discharge. Samples used for

determining compliance with the water quality standards in the receiving water shall not be taken from the treatment pond prior to decanting. Compliance with the water quality standards is determined in the receiving water.

### **Operator Training**

Each contractor who intends to use chemical treatment shall be trained by an experienced contractor . Each site using chemical treatment must have an operator trained and certified by an organization approved by Ecology.

### **Standard BMPs**

Surface stabilization BMPs should be implemented on site to prevent significant erosion. All sites shall use a truck wheel wash to prevent tracking of sediment off site.

### **Sediment Removal and Disposal**

- Sediment shall be removed from the storage or treatment cells as necessary. Typically, sediment removal is required at least once during a wet season and at the decommissioning of the cells. Sediment remaining in the cells between batches may enhance the settling process and reduce the required chemical dosage.
- Sediment that is known to be non-toxic may be incorporated into the site away from drainages.

## BMP C251: Construction Stormwater Filtration

---

### Purpose and Description

Filtration removes sediment from runoff originating from disturbed areas of the site.

### Background Information:

Filtration with sand media has been used for over a century to treat water and wastewater. The use of sand filtration for treatment of stormwater has developed recently, generally to treat runoff from streets, parking lots, and residential areas. The application of filtration to construction stormwater treatment is currently under development.

### Conditions of Use

Traditional BMPs used to control soil erosion and sediment loss from sites under development may not be adequate to ensure compliance with the water quality standard for turbidity in the receiving water. Filtration may be used in conjunction with gravity settling to remove sediment as small as fine silt (0.5  $\mu\text{m}$ ). In some circumstances, sedimentation and filtration together may achieve compliance with the water quality standard for turbidity.

The use of construction stormwater filtration does not require approval from Ecology as long as treatment chemicals are not used. Filtration in conjunction with polymer treatment requires testing under the Chemical Technology Assessment Protocol – Ecology (CTAPE) before it can be initiated. Approval from the appropriate regional Ecology office must be obtained at each site where polymers use is proposed prior to use. For more guidance on stormwater chemical treatment see [BMP C250](#).

### Design Criteria

Two types of filtration systems may be applied to construction stormwater treatment: rapid and slow. Rapid sand filters are the typical system used for water and wastewater treatment. They can achieve relatively high hydraulic flow rates, on the order of 2 to 20 gpm/sf, because they have automatic backwash systems to remove accumulated solids. In contrast, slow sand filters have very low hydraulic rates, on the order of 0.02 gpm/sf, because they do not have backwash systems. Slow sand filtration has generally been used to treat stormwater. Slow sand filtration is mechanically simple in comparison to rapid sand filtration but requires a much larger filter area.

### Filtration Equipment

Sand media filters are available with automatic backwashing features that can filter to 50  $\mu\text{m}$  particle size. Screen or bag filters can filter down to 5  $\mu\text{m}$ . Fiber wound filters can remove particles down to 0.5  $\mu\text{m}$ . Filters should be sequenced from the largest to the smallest pore opening. Sediment removal efficiency will be related to particle size distribution in the stormwater.



## Treatment Process Description

Stormwater is collected at interception point(s) on the site and is diverted to an untreated stormwater sediment pond or tank for removal of large sediment and storage of the stormwater before it is treated by the filtration system. The untreated stormwater is pumped from the trap, pond, or tank through the filtration system in a rapid sand filtration system. Slow sand filtration systems are designed as flow through systems using gravity.

## Sizing Criteria for Flow-Through Treatment Systems for Flow Control Exempt Water Bodies

When sizing storage ponds or tanks for flow-through systems for flow control exempt water bodies the treatment system capacity should be a factor. The untreated stormwater storage pond or tank should be sized to hold 1.5 times the runoff volume of the 10-year, 24-hour storm event minus the treatment system flowrate for an 8-hour period. For a chitosan-enhanced sand filtration system, the treatment system flowrate should be sized using a hydraulic loading rate between 6-8 gpm/ft<sup>2</sup>. Other hydraulic loading rates may be more appropriate for other systems. Bypass should be provided around the chemical treatment system to accommodate extreme storms. Runoff volume shall be calculated using the methods presented in [Chapter 1](#). Analyses shall be performed using worst-case site conditions (i.e., those producing the most runoff during site development).

## Sizing Criteria for Flow Control Water Bodies

Sites that must implement flow control for the developed site condition must also control stormwater release rates during construction. Construction site stormwater discharges shall not exceed the discharge durations of the pre-developed condition for the range of pre-developed discharge rates from 1/2 of the 2-year flow through the 10-year flow as predicted by an approved continuous flow model. The pre-developed condition to be matched shall be the land cover condition immediately prior to the development project. This restriction on release rates can affect the size of the storage pond, the filtration system, and the flow rate through the filter system.

The following is how WWHM can be used to determine the release rates from the filtration systems:

1. Determine the pre-developed flow durations to be matched by entering the land use area under the “Pre-developed” scenario in WWHM. The default flow range is from 1/2 of the 2-year flow through the 10-year flow.
2. Enter the post developed land use area in the “Developed Unmitigated” scenario in WWHM.
3. Copy the land use information from the “Developed Unmitigated” to “Developed Mitigated” scenario.
4. There are two possible ways to model stormwater filtration systems:
  - v. The stormwater filtration system uses an untreated stormwater storage pond/tank and the discharge from this pond/tank is pumped to one or more filters. In-line

filtration chemicals would be added to the flow right after the pond/tank and before the filter(s). Because the discharge is pumped, WWHM can't generate a stage/storage/discharge (SSD) table for this system. This system is modeled the same way as described in [BMP C250](#) and is as follows:

While in the “Developed Mitigated” scenario, add a pond element under the basin element containing the post-developed land use areas. This pond element represents information on the available untreated stormwater storage and discharge from the filtration system. In cases where the discharge from the filtration system is controlled by a pump, a stage/storage/discharge (SSD) table representing the pond must be generated outside WWHM and imported into WWHM. WWHM can route the runoff from the post-developed condition through this SSD table (the pond) and determine compliance with the flow duration standard. This would be an iterative design procedure where if the initial SSD table proved to be out of compliance, the designer would have to modify the SSD table outside WWHM and re-import in WWHM and route the runoff through it again. The iteration will continue until a pond that enables compliance with the flow duration standard is designed.

Notes on SSD table characteristics:

- The pump discharge rate would likely be initially set at just below  $\frac{1}{2}$  if the 2-year flow from the pre-developed condition. As runoff coming into the untreated stormwater storage pond increases and the available untreated stormwater storage volume gets used up, it would be necessary to increase the pump discharge rate above  $\frac{1}{2}$  of the 2-year. The increase(s) above  $\frac{1}{2}$  of the 2-year must be such that they provide some relief to the untreated stormwater storage needs but at the same time they will not cause violations of the flow duration standard at the higher flows. The final design SSD table will identify the appropriate pumping rates and the corresponding stage and storages.
- When building such a flow control system, the design must ensure that any automatic adjustments to the pumping rates will be as a result of changes to the available storage in accordance with the final design SSD table.
- w. The stormwater filtration system uses a storage pond/tank and the discharge from this pond/tank gravity flows to the filter. This is usually a slow sand filter system and it is possible to model it in WWHM as a Filter element or as a combination of Pond and Filter element placed in series. The stage/storage/discharge table(s) may then be generated within WWHM as follows:
  - While in the “Developed Mitigated” scenario, add a Filter element under the basin element containing the post-developed land use areas. The length and width of this filter element would have to be the same as the bottom length and width of the upstream untreated stormwater storage pond/tank.

- In cases where the length and width of the filter is not the same as those for the bottom of the upstream untreated stormwater storage tank/pond, the treatment system may be modeled as a Pond element followed by a Filter element. By having these two elements, WWHM would then generate a SSD table for the storage pond which then gravity flows to the Filter element. The Filter element downstream of the untreated stormwater storage pond would have a storage component through the media, and an overflow component for when the filtration capacity is exceeded.
  - WWHM can route the runoff from the post-developed condition through the treatment systems in 4b and determine compliance with the flow duration standard. This would be an iterative design procedure where if the initial sizing estimates for the treatment system proved to be inadequate, the designer would have to modify the system and route the runoff through it again. The iteration would continue until compliance with the flow duration standard is achieved.
5. It should be noted that the above procedures would be used to meet the flow control requirements. The filtration system must be able to meet the runoff treatment requirements. It is likely that the discharge flow rate of 1/2 of the 2-year or more may exceed the treatment capacity of the system. If that is the case, the untreated stormwater discharge rate(s) (i.e., influent to the treatment system) must be reduced to allow proper treatment. Any reduction in the flows would likely result in the need for a larger untreated stormwater storage volume.

If system design does not allow discharging at the slower rates as described above and if the site has a retention or detention pond that will serve the planned development, the discharge from the treatment system may be directed to the permanent retention/detention pond to comply with the flow control requirements. In this case, the untreated stormwater storage pond and treatment system will be sized according to the sizing criteria for flow-through treatment systems for flow control exempt waterbodies described earlier except all discharges (water passing through the treatment system and stormwater bypassing the treatment system) will be directed into the permanent retention/detention pond. If site constraints make locating the untreated stormwater storage pond difficult, the permanent retention/detention pond may be divided to serve as the untreated stormwater discharge pond and the post-treatment flow control pond. A berm or barrier must be used in this case so the untreated water does not mix with the treated water. Both untreated stormwater storage requirements, and adequate post-treatment flow control must be achieved. The post-treatment flow control pond's revised dimensions must be entered into the WWHM and the WWHM must be run to confirm compliance with the flow control requirement.

## Maintenance Standards

Rapid sand filters typically have automatic backwash systems that are triggered by a pre-set pressure drop across the filter. If the backwash water volume is not large or substantially more turbid than

the untreated stormwater stored in the holding pond or tank, backwash return to the untreated stormwater pond or tank may be appropriate. However, other means of treatment and disposal may be necessary.

- Screen, bag, and fiber filters must be cleaned and/or replaced when they become clogged.
- Sediment shall be removed from the storage and/or treatment ponds as necessary. Typically, sediment removal is required once or twice during a wet season and at the decommissioning of the ponds.

## BMP C252: High pH Neutralization Using CO<sub>2</sub> (Carbon Dioxide Sparging)

---

### Purpose and Description

When pH levels in stormwater rise above 8.5 it is necessary to lower the pH levels to the acceptable range of 6.5 to 8.5, this process is called pH neutralization. pH neutralization involves the use of solid or compressed carbon dioxide gas in water requiring neutralization. Neutralized stormwater may be discharged to surface waters under the General Construction NPDES permit.

Neutralized process water such as concrete truck wash-out, hydro-demolition, or saw-cutting slurry must be managed to prevent discharge to surface waters. Any stormwater contaminated during concrete work is considered process wastewater and must not be discharged to surface waters.

### Conditions of Use

#### Causes of High pH

High pH at construction sites is most commonly caused by the contact of stormwater with poured or recycled concrete, cement, mortars, and other Portland cement or lime-containing construction materials. (See [BMP C151](#): Concrete Handling for more information on concrete handling procedures.) The principal caustic agent in cement is calcium hydroxide (free lime).

#### Advantages of CO<sub>2</sub> Sparging

- Rapidly neutralizes high pH water.
- Cost effective and safer to handle than acid compounds.
- CO<sub>2</sub> is self-buffering. It is difficult to overdose and create harmfully low pH levels.
- Material is readily available.

#### The Chemical Process

When carbon dioxide (CO<sub>2</sub>) is added to water (H<sub>2</sub>O), carbonic acid (H<sub>2</sub>CO<sub>3</sub>) is formed which can further dissociate into a proton (H<sup>+</sup>) and a bicarbonate anion (HCO<sub>3</sub><sup>-</sup>) as shown below:



The free proton is a weak acid that can lower the pH. Water temperature has an effect on the reaction as well. Colder water temperatures slow the reaction.

## Design Criteria

### Treatment Process

High pH water may be treated using continuous treatment, continuous discharge systems. These manufactured systems continuously monitor influent and effluent pH to ensure that pH values are within an acceptable range before being discharged. All systems must have fail safe automatic shut off switches in the event that pH is not within the acceptable discharge range. Only trained operators may operate manufactured systems. System manufacturers often provide trained operators or training on their devices.

The following procedure may be used when not using a continuous discharge system:

1. Every effort should be made to isolate the potential high pH water in order to treat it separately from other stormwater on-site.
2. Water should be stored in an acceptable storage facility, detention pond, or containment cell prior to treatment.
3. Transfer water to be treated to the treatment structure. Ensure that treatment structure size is sufficient to hold the amount of water that is to be treated. Do not fill tank completely, allow at least 2 feet of freeboard.
4. The operator samples the water for pH and notes the clarity of the water. As a rule of thumb, less CO<sub>2</sub> is necessary for clearer water. Record pH and clarity in a log.
5. In the pH adjustment structure, add CO<sub>2</sub> until the pH falls in the range of 6.9-7.1. Compressed carbon dioxide gas should be introduced to the water using a carbon dioxide diffuser located near the bottom of the tank, this will allow carbon dioxide to bubble up through the water and diffuse more evenly.
6. Slowly discharge the water making sure water does not get stirred up in the process. Release about 80% of the water from the structure leaving any sludge behind.
7. Discharge treated water through a pond or drainage system.
8. Dispose excess sludge properly as concrete waste. If several batches of water are undergoing pH treatment, sludge can be left in treatment structure for the next batch treatment. Dispose of sludge when it fills 50% of tank volume.

Sites that must implement flow control for the developed site must also control stormwater release rates during construction. All treated stormwater must go through a flow control facility before being released to surface waters which require flow control.

## Maintenance Standards

### Safety and Materials Handling:

- All equipment should be handled in accordance with OSHA rules and regulations.
- Follow manufacturer guidelines for materials handling.

### Operator Records:

Each operator should provide:

- A diagram of the monitoring and treatment equipment.
- A description of the pumping rates and capacity the treatment equipment is capable of treating.

Each operator should keep a written record of the following:

- Client name and phone number.
- Date of treatment.
- Weather conditions.
- Project name and location.
- Volume of water treated.
- pH of untreated water.
- Amount of CO<sub>2</sub> needed to adjust water to a pH range of 6.9-7.1.
- pH of treated water.
- Discharge point location and description.

A copy of this record should be given to the client/contractor who should retain the record for three years.

## BMP C253: Control of High pH Water

---

### Purpose and Description

Prevent discharge of stormwater with a pH greater than 8.5 if [BMP C252](#) is not used.

### Conditions of Use

Stormwater with a pH greater than 8.5 may be discharged to surface water only after treatment by one of the following methods:

- [BMP C252](#) – High pH Neutralization
- [BMP T5.30A/B](#) – Full Dispersion (see [Book 1, Chapter 2](#))
- Alternatively, such stormwater may be infiltrated using an infiltration BMP designed in accordance with [Chapters 5](#) and [6](#).

In no case shall stormwater with pH greater than 8.5 be discharged to surface waters of the state.

### Design Criteria

See requirements set forth in the selected BMP(s).



## Book 2 References

Center for Watershed Protection, “Better Site Design”, August 1998.

Chang, George, C., “Review of Stormwater Manual-Sand Filtration Basins for Department of Ecology, State of Washington”, November 5, 2000.

Chow, V.T., "Open Channel Hydraulics", McGraw-Hill Book Co., New York, 1959.

City of Portland, Oregon, “Portland Stormwater Management Manual”, 2008.

Clean Water Services, “Low Impact Development Approaches Handbook”, July 2009.

Hinman, Curtis, “Rain Garden Handbook for Western Washington Homeowners”, WSU Pierce County Extension, June 2013.

Hinman, Curtis, “Low Impact Development Technical Guidance Manual for Puget Sound”, WSU Puyallup Research & Extension Center and Puget Sound Partnership, December 2012.

Jaisinghani, R., A., et. al., “A Study of Oil/Water Separation in Corrugated Plate Separators,” Journal of Engineering for Industry, 11/79.

King County Surface Water Management, Design Manual, September, 1998.

King County Surface Water Management, Design Manual, 2009.

Schueler, Thomas R., “Water Quality inlets/Oil Grit Separators,” BMP Fact Sheet #11, Current Assessment of Urban Best Management Practices, March 1992.

Washington State Department of Ecology, “Stormwater Management Manual for Western Washington”, August 2012.

Washington State Department of Ecology, “Stormwater Management Manual for Western Washington”, December 2014.

Washington State Department of Transportation, “Highway Runoff Manual”, 2014.

Washington State Department of Transportation, “Hydraulics Manual”, 2010.

ASCE and WEF, Urban Runoff Quality Management, WEF Manual of Practice No. 23, 1998.

This page left blank intentionally

# Book 2 Appendices

Appendix 2-A	Hydrology
Appendix 2-B	WWHM Information, Assumptions, and Computational Steps
Appendix 2-C	Low Impact Development Modeling Guidance
Appendix 2-D	Approaches to Infiltration Facility Design
Appendix 2-E	Bioretention Soil Mix Hydraulic Conductivity
Appendix 2-F	Turbulence and Short-Circuiting Factor
Appendix 2-G	Geotextile Specifications

This page left blank intentionally

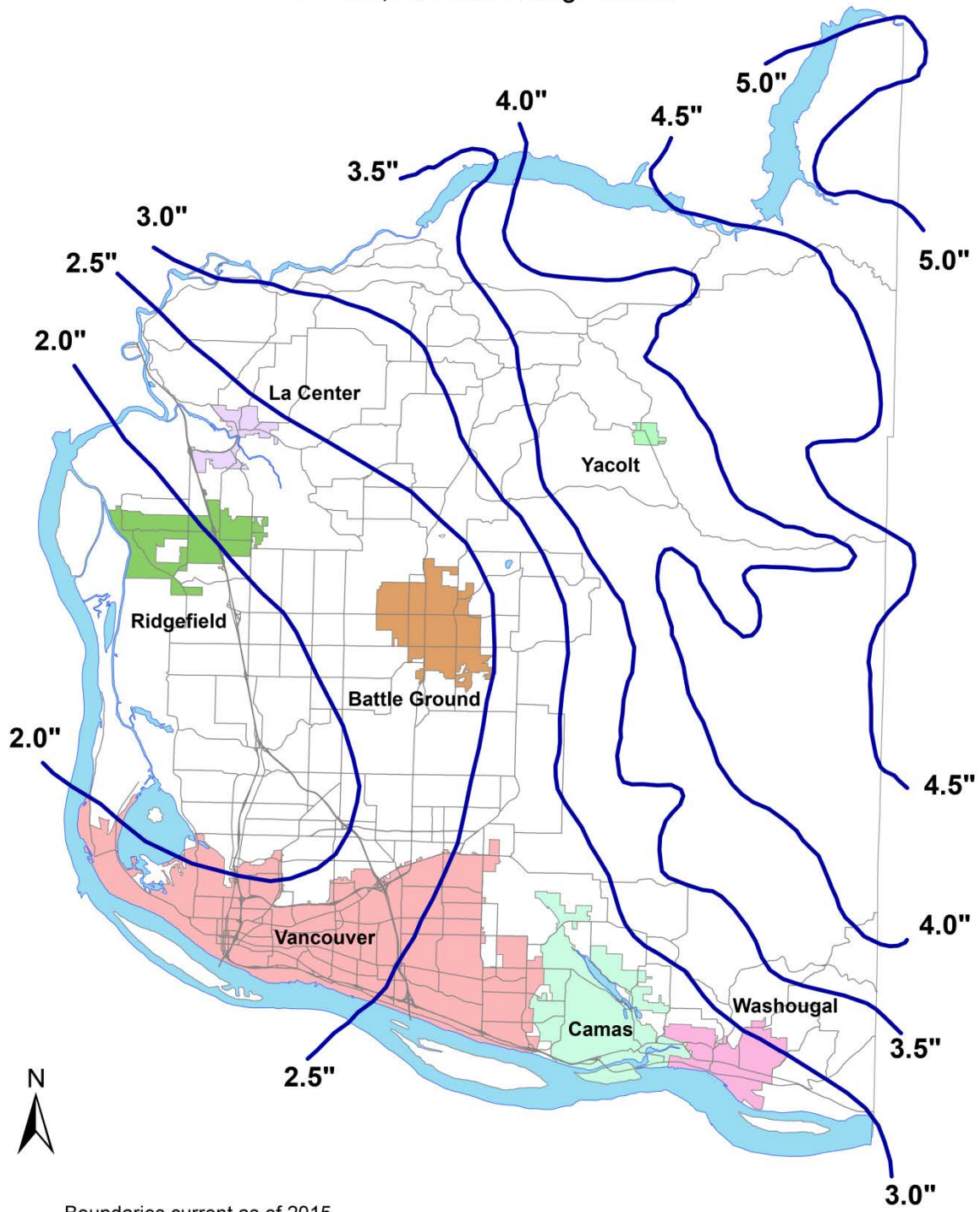
# Appendix 2-A

## Hydrology

Isopluvial Maps.....	1
Sheet Flow Values in Time Calculations for Hydrographs .....	5
Open Channel Roughness Coefficient .....	6
Hydrologic Soil Groups in Clark County .....	7
Intensity-Duration-Frequency Curves .....	11
Table of Runoff Coefficients for the Rational Method.....	14
24-Hour Design Storm Hyetograph Values.....	15



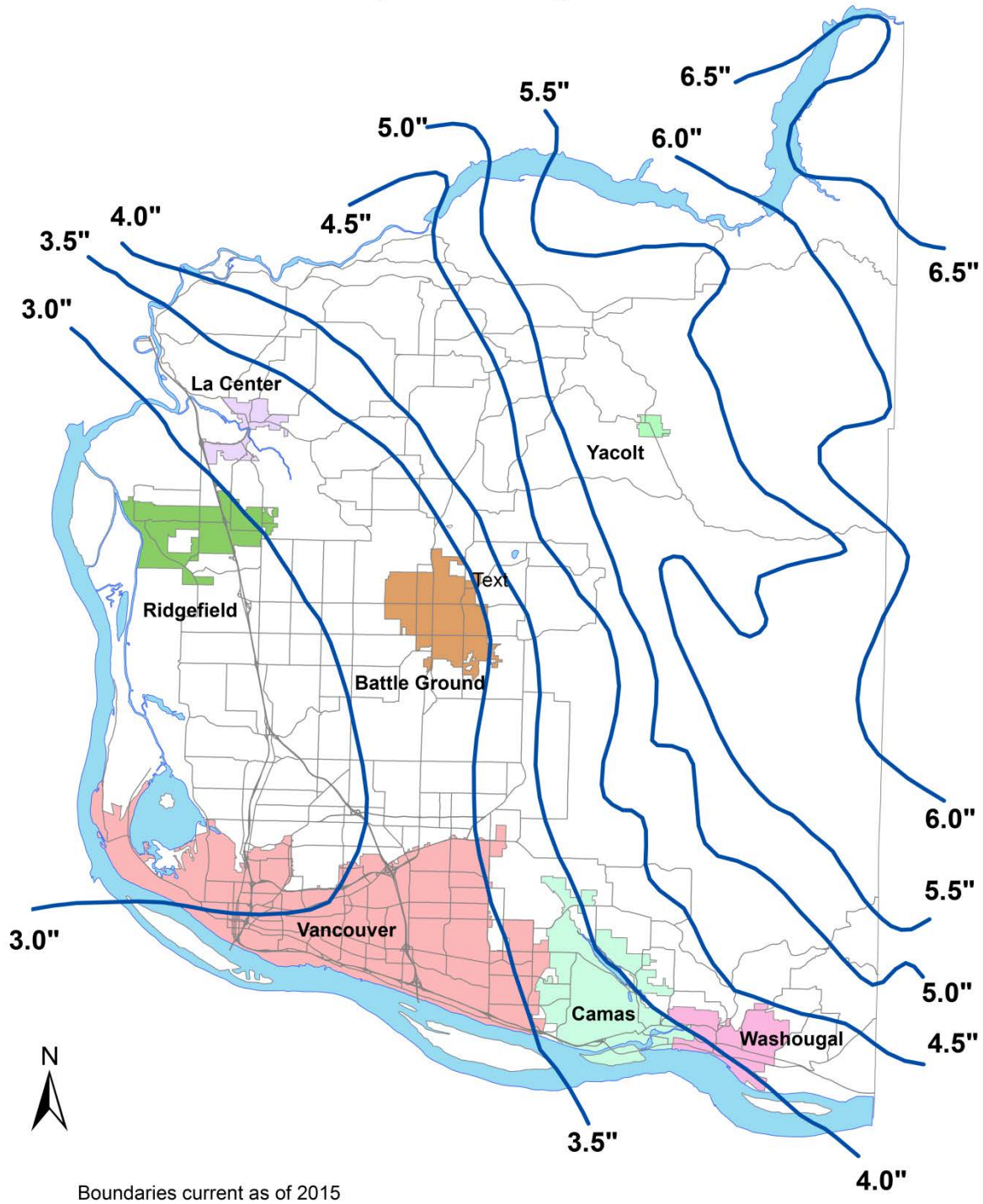
### Isopluvial Map for Clark County 2-Year, 24-Hour Design Storm



Boundaries current as of 2015

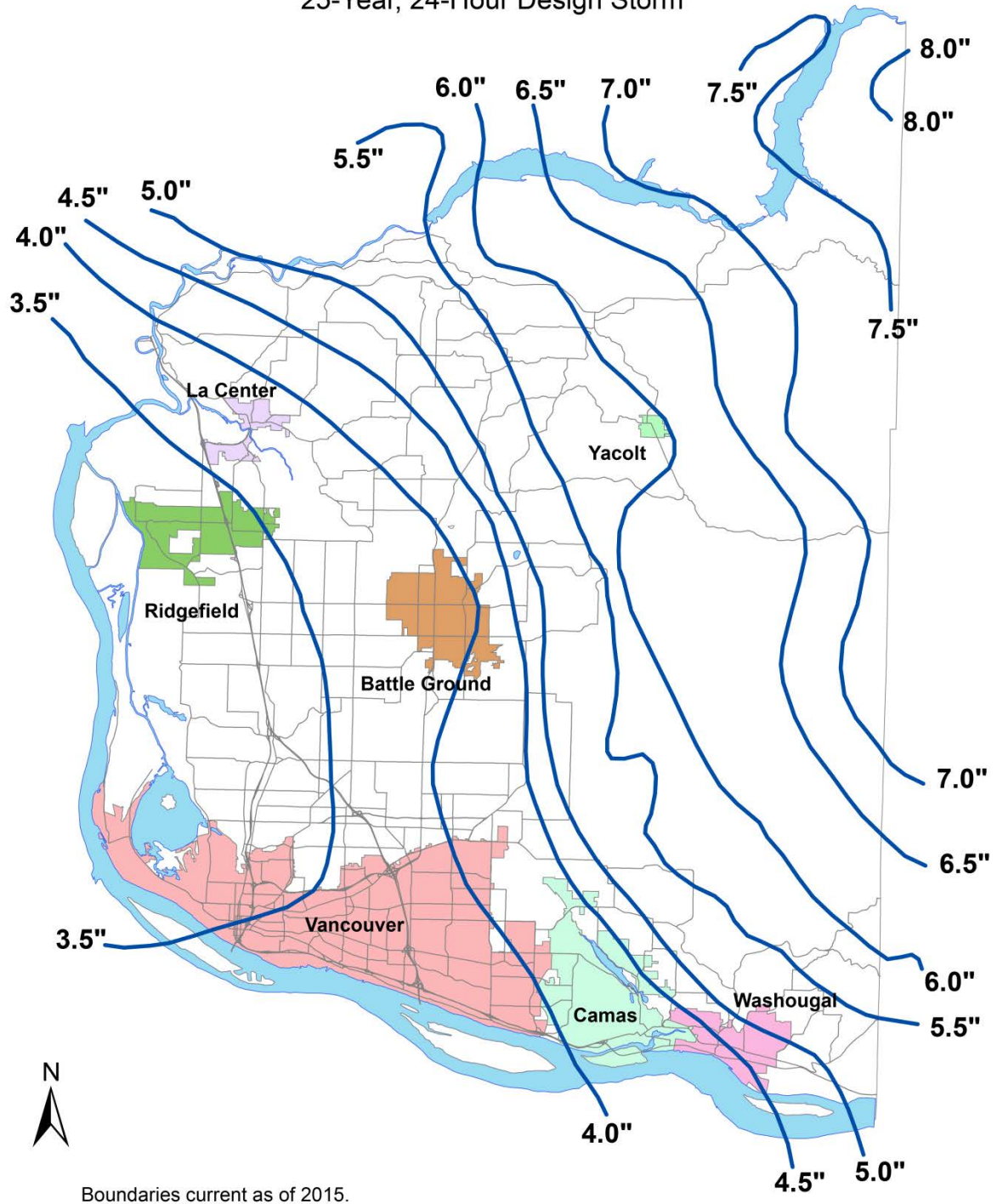
# Isopluvial Map for Clark County

## 10-Year, 24-Hour Design Storm





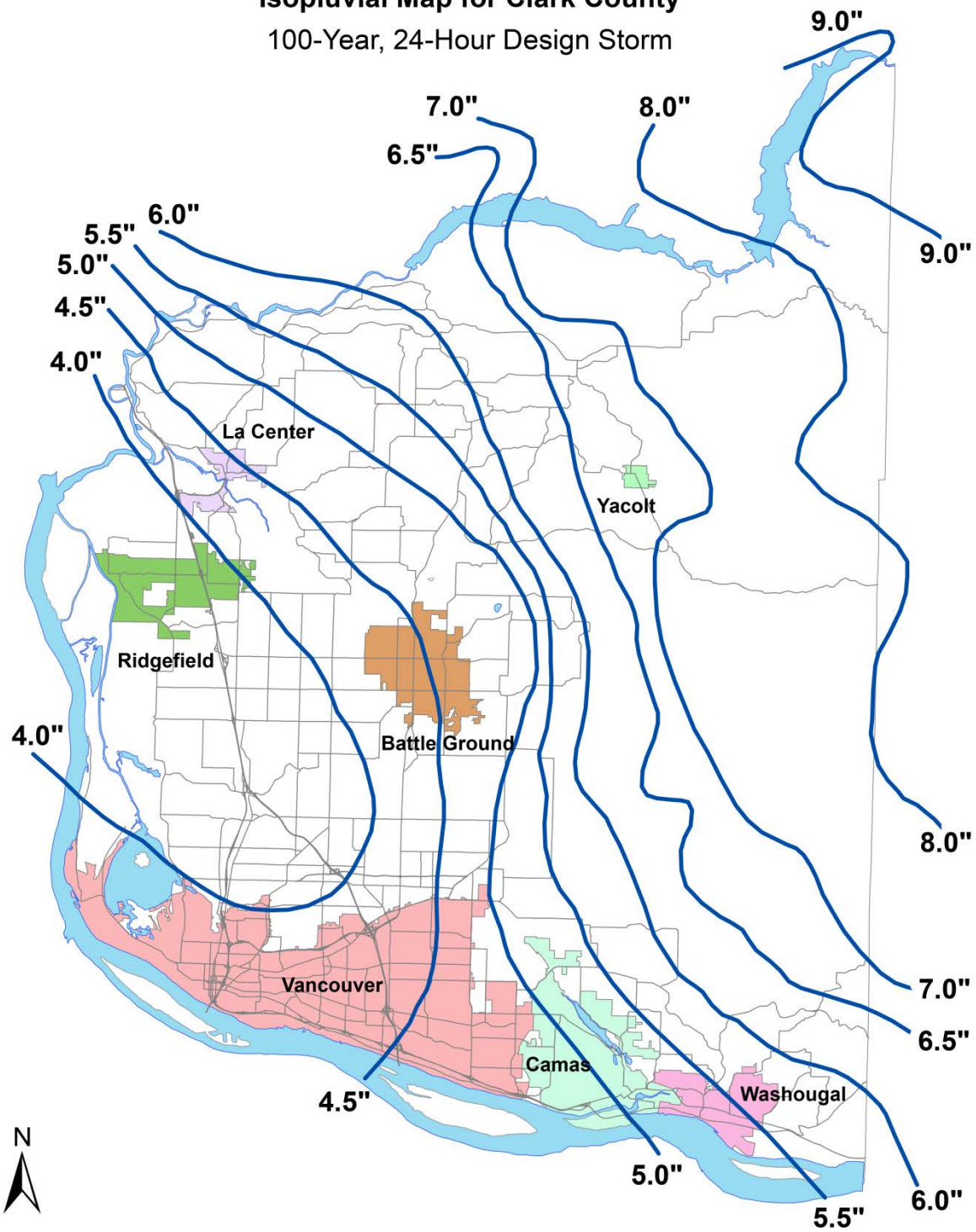
### Isopluvial Map for Clark County 25-Year, 24-Hour Design Storm



Boundaries current as of 2015.

# Isopluvial Map for Clark County

## 100-Year, 24-Hour Design Storm



Boundaries current as of 2015.

## Sheet flow “n” Values and “k” Values Used in Time Calculations for Hydrographs

<u>“n<sub>s</sub>” Sheet Flow Equation Manning’s Values (for the initial 300 feet of travel)</u>	<u>n<sub>s</sub>*</u>
Smooth surfaces (concrete, asphalt, gravel, or bare hand packed soil)	0.011
Fallow fields or loose soil surface (no residue)	0.05
Cultivated soil with residue cover (s≤ 0.20 ft/ft)	0.06
Cultivated soils with residue cover (s> 0.20 ft/ft)	0.17
Short prairie grass and lawns	0.15
Dense grasses	0.24
Bermuda grass	0.41
Range (natural)	0.13
Woods or forest with light underbrush	0.40
Woods or forest with dense underbrush	0.80
*Manning values for sheet flow only, from Overton and Meadows 1976 (See TR-55, 1986)	
<b>“k” Values Used in Travel Time/Time of Concentration Calculations</b>	
<u>Shallow Concentrated Flow (After the initial 300 feet of sheet flow, R = 0.1)</u>	<u>k<sub>s</sub></u>
1. Forest with heavy ground litter and meadows (n = 0.10)	3
2. Brushy ground with some trees (n = 0.060)	5
3. Fallow or minimum tillage cultivation (n = 0.040)	8
4. High grass (n = 0.035)	9
5. Short grass, pasture and lawns (n = 0.030)	11
6. Nearly bare ground (n = 0.25)	13
7. Paved and gravel areas (n = 0.012)	27
<u>Channel Flow (intermittent) (At the beginning of visible channels R = 0.2)</u>	<u>k<sub>c</sub></u>
1. Forested swale with heavy ground litter (n = 0.10)	5
2. Forested drainage course/ravine with defined channel bed (n = 0.050)	10
3. Rock-lined waterway (n = 0.035)	15
4. Grassed waterway (n = 0.030)	17
5. Earth-lined waterway (n = 0.025)	20
6. CMP pipe (n = 0.024)	21
7. Concrete pipe (0.012)	42
8. Other waterways and pipe	0.508/n
<u>Channel Flow (Continuous stream, R = 0.4)</u>	<u>k<sub>c</sub></u>
9. Meandering stream with some pools (n = 0.040)	20
10. Rock-lined stream (n = 0.035)	23
11. Grass-lined stream (n = 0.030)	27
12. Other Stream, man-made channels and pipe	0.807/n

Reference: DOE Stormwater Management Manual for the Puget Sound Basin, February 1992.

**Values of the Open Channel Roughness Coefficient, “n”**

Type of Channel and Description	Manning's "n"
<b>A. Constructed Channels</b>	
a. Earth, straight and uniform	
1. Clean, recently completed	0.018
2. Gravel, uniform section, clean	0.025
3. With short grass, few weeds	0.027
b. Earth, winding and sluggish	
1. No vegetation	0.025
2. Grass, some weeds	0.030
3. Dense weeds or aquatic plants in deep channels	0.035
4. Earth bottom and rubble sides	0.030
5. Stony bottom and weedy banks	0.035
6. Cobble bottom and clean sides	0.040
c. Rock lined	
1. Smooth and uniform	0.035
2. Jagged and irregular	0.040
d. Channels not maintained, weeds and brush uncut	
1. Dense weeds, high as flow depth	0.080
2. Clean bottom, brush on sides	0.050
3. Same as above, highest stage of flow	0.070
4. Dense brush, high stage	0.100
<b>B. Natural Streams</b>	
B-1 Minor streams (top width at flood stage < 100 ft.)	
a. Streams on plain	
1. Clean, straight, full stage no rifts or deep pools	0.030
2. Same as above, but more stones and weeds	0.035
3. Clean, winding, some pools and shoals	0.040
4. Same as above, but some weeds	0.040
5. Same as 4, but more stones	0.050
6. Sluggish reaches, weedy deep pools	0.070
7. Very weedy reaches, deep pools, or floodways with heavy stand of timber and underbrush	0.100

Type of Channel and Description	Manning's "n"
b. Mountain streams, no vegetation in channel, banks usually steep, trees and brush along banks submerged at high stages	
1. Bottom: gravel, cobbles, and few boulders	0.040
2. Bottom: cobbles with large boulders	0.050
<b>B-2 Flood plains</b>	
a. Pasture, no brush	
1. short grass	0.030
2. High grass	0.035
b. Cultivated areas	
1. No crop	0.030
2. Mature row crops	0.035
3. Mature field crops	0.040
c. Brush	
1. Scattered brush, heavy weeds	0.050
2. Light brush and trees	0.060
3. Medium to dense brush	0.070
4. Heavy, dense brush	0.100
d. Trees	
1. Dense willows, straight	0.150
2. Cleared land with tree stumps, no sprouts	0.040
3. Same as above, but with heavy growth of sprouts	0.060
4. Heavy stand of timber, a few down trees, little undergrowth, flood stage below branches	0.100
5. Same as above, but with flood stage reaching branches	0.120

Reference: DOE Stormwater Management Manual for Puget Sound Basin, February 1992

## Hydrologic Soil Groups for Soils in Clark County

U.S. Department of Agriculture  
Soil Conservation Service

### WATER FEATURES

Survey Area: CLARK COUNTY, WASHINGTON

Map Symbol	Soil Name	Hydrologic Group	Clark County WWHM Soils Group
BpB	BEAR PRARIE	B	2
BpC	BEAR PRARIE	B	2
CnB	CINEBAR	B	2
CnD	CINEBAR	B	2
CnE	CINEBAR	B	2
CnG	CINEBAR	B	2
CrE	CINEBAR	B	2
CrG	CINEBAR	B	2
CsF	CISPUS	B	2
CtA	CLOQUATO	B	2
CvA	COVE	D	4
CwA	COVE	D	4
DoB	DOLLAR	C	3
Fn	FILL LAND	In-situ	N/A
GeB	GEE	C	4
GeD	GEE	C	4
GeE	GEE	C	4
GeF	GEE	C	4
GuB	GUMBOOT	D	4
HcB	HESSON	C	3
HcD	HELLSON	C	3
HcE	HESSON	C	3
HcF	HESSON	C	3
HgB	HESSON	C	3
HgD	HESSON	C	3
HhE	HESSON	C	3
HIA	HILLSBORO	B	2
HIB	HILLSBORO	B	2

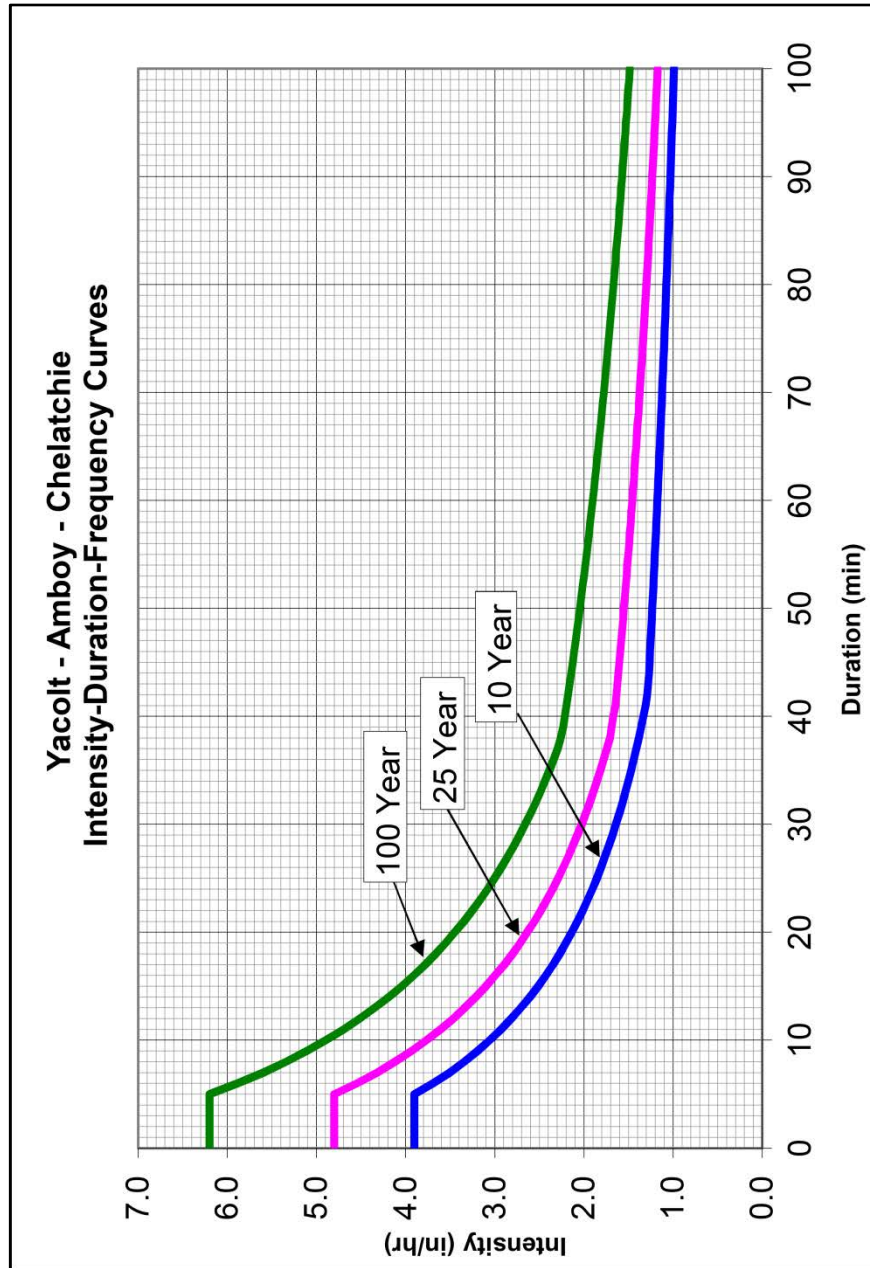
<b>Map Symbol</b>	<b>Soil Name</b>	<b>Hydrologic Group</b>	<b>Clark County WWHM Soils Group</b>
HIC	HILLSBORO	B	2
HID	HILLSBORO	B	2
HIE	HILLSBORO	B	2
HIF	HILLSBORO	B	2
HoA	HILLSBORO	B	3
HoB	HILLSBORO	B	3
HoC	HILLSBORO	B	3
HoD	HILLSBORO	B	3
HoE	HILLSBORO	B	3
HoG	HILLSBORO	B	3
HsB	HILLSBORO	B	3
HtA	HOCKINSON	D	4
HuB	HOCKINSON	D	4
HvA	HOCKINSON	D	4
KcC	KINNEY	B	2
KcE	KINNEY	B	2
KcF	KINNEY	B	2
KnF	KINNEY	B	2
LaE	LARCHMOUNT	B	2
LaG	LARCHMOUNT	B	2
LcG	LARCHMOUNT	B	2
LeB	LAUREN	B	1
LgB	LAUREN	B	1
LgD	LAUREN	B	1
LgF	LAUREN	B	1
LIB	LAUREN	B	1
LrC	LAUREN	C	4
LrF	LAUREN	C	4
McB	McBEE	C	3
MeA	McBEE	C	3
MIA	McBEE	C	3
MnA	MINNIECE	D	4
MnD	MINNIECE	D	4
MoA	MINNIECE VARIANT	D	4
MsB	MOSSYROCK	B	2

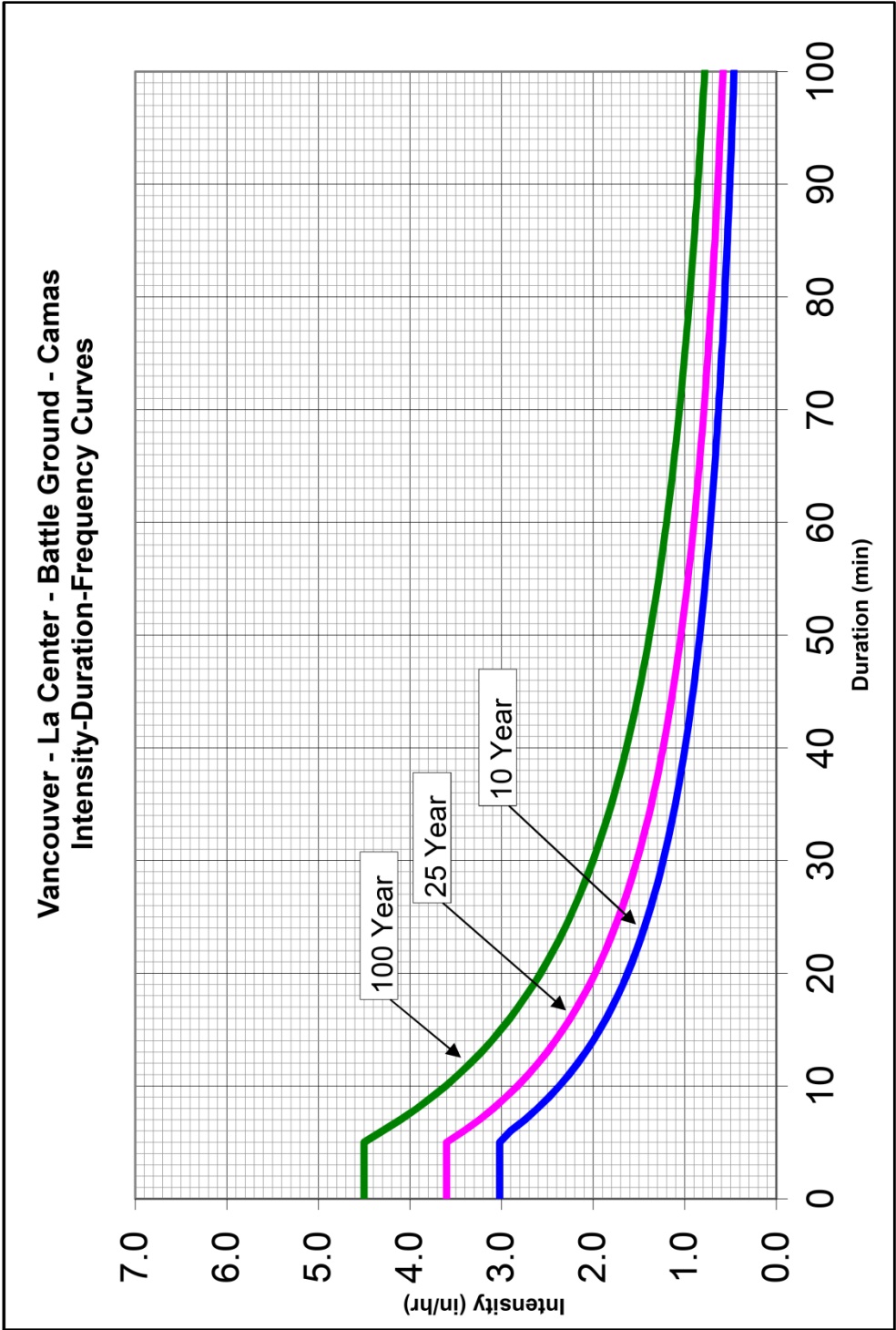
Map Symbol	Soil Name	Hydrologic Group	Clark County WWHM Soils Group
NbA	NEWBERG	B	2
NbB	NEWBERG	B	2
OdB	ODNE	D	4
OeD	OLEQUA	B	3
OeE	OLEQUA	B	3
OeF	OLEQUA	B	3
OhD	OLEQUA VARIANT	C	4
OhF	OLEQUA VARIANT	C	4
OIB	OLYMPIC	B	3
OID	OLYMPIC	B	3
OIE	OLYMPIC	B	3
OIF	OLYMPIC	B	3
OmE	OLYMPIC	B	3
OmF	OLYMPIC	B	3
OpC	OLYMPIC VARIANT	C	3
OpE	OLYMPIC VARIANT	C	3
OpG	OLYMPIC VARIANT	C	3
OrC	OLYMPIC VARIANT	C	3
PhB	PILCHUCK	C	2
PoB	POWELL	C	3
PoD	POWELL	C	3
PoE	POWELL	C	3
PuA	PUYALLUP	B	2
Ra	RIVERWASH	D	N/A
Rc	RIVERWASH	D	N/A
Rk	ROCK LAND	D	N/A
Ro	ROUGH BROKEN LAND	A	1
SaC	SALKUM	B	2
SIB	SARA	D	4
SID	SARA	D	4
SIF	SARA	D	4
SmA	SAUVIE	B	3
SmB	SAUVIE	B	3
SnA	SAUVIE	D	3
SpB	SAUVIE	B	3

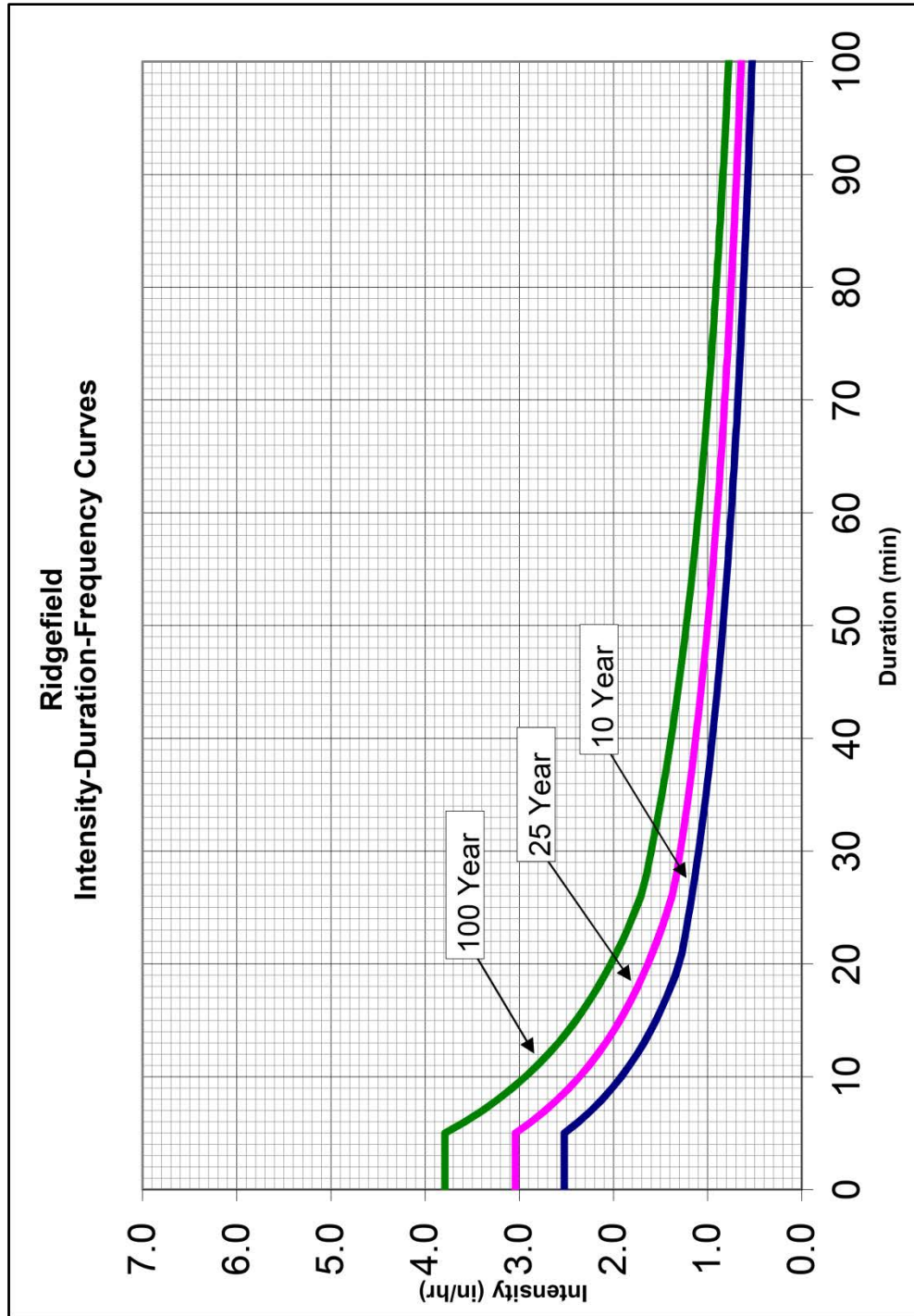
<b>Map Symbol</b>	<b>Soil Name</b>	<b>Hydrologic Group</b>	<b>Clark County WWHM Soils Group</b>
Sr	SEMIAHMOO	C	5
Su	SEMIAHMOO VARIANT	D	5
SvA	SIFTON	B	1
ThA	TISCH	D	5
VaB	VADER	B	2
VaC	VADER	B	2
WaA	WASHOUGAL	B	2
WgB	WASHOUGAL	B	2
WgE	WASHOUGAL	B	2
WhF	WASHOUGAL	B	2
WnB	WIND RIVER VARIANT	B	1
WnD	WIND RIVER VARIANT	B	1
WnG	WIND RIVER VARIANT	B	1
WrB	WIND RIVER VARIANT	B	1
WrF	WIND RIVER VARIANT	B	1
YaA	YACOLT	B	2
YaC	YACOLT	B	2
YcB	YACOLT	B	2



# Intensity-Duration-Frequency Curves







Runoff Coefficients for the Rational Method			
Type of Cover	Flat	Rolling 2% - 10%	Hilly Over 10%
Pavement and Roofs	0.90	0.90	0.90
Earth Shoulders	0.50	0.50	0.50
Drives and Walks	0.75	0.80	0.85
Gravel Pavement	0.50	0.55	0.60
City Business Areas	0.80	0.85	0.85
Suburban Residential	0.25	0.35	0.40
Single Family Residential	0.30	0.40	0.50
Multi Units, Detached	0.40	0.50	0.60
Multi Units, Attached	0.60	0.65	0.70
Lawns, Very Sandy Soil	0.05	0.07	0.10
Lawns, Sandy Soil	0.10	0.15	0.20
Lawns, Heavy Soil	0.17	0.22	0.35
Grass Shoulders	0.25	0.25	0.25
Side Slopes, Earth	0.60	0.60	0.60
Side Slopes, Turf	0.30	0.30	0.30
Median Areas, Turf	0.25	0.30	0.30
Cultivated Land, Clay and Loam	0.50	0.55	0.60
Cultivated Land, Sand and Gravel	0.25	0.30	0.35
Industrial Areas, Light	0.50	0.70	0.80
Industrial Areas, Heavy	0.60	0.80	0.90
Parks and Cemeteries	0.10	0.15	0.25
Playgrounds	0.20	0.25	0.30
Woodland and Forests	0.10	0.15	0.20
Meadows and Pasture Land	0.25	0.30	0.35
Pasture with Frozen Ground	0.40	0.45	0.50
Unimproved Areas	0.10	0.20	0.30

## 24-Hour Design Storm Hyetograph Values

Time (hours)	Time (minutes)	Percent Rainfall	Cumulative Percent Rainfall
0.0	0	0.0	0.0
	10	0.4	0.4
	20	0.4	0.8
	30	0.4	1.2
	40	0.4	1.6
	50	0.4	2.0
1.0	60	0.4	2.4
	70	0.4	2.8
	80	0.4	3.2
	90	0.4	3.6
	100	0.4	4.0
	110	0.5	4.5
2.0	120	0.5	5.0
	130	0.5	5.5
	140	0.5	6.0
	150	0.5	6.5
	160	0.5	7.0
	170	0.6	7.6
3.0	180	0.6	8.2
	190	0.6	8.8
	200	0.6	9.4
	210	0.6	10.0
	220	0.6	10.6
	230	0.7	11.3
4.0	240	0.7	12.0
	250	0.7	12.7
	260	0.7	13.4
	270	0.7	14.1
	280	0.7	14.8
	290	0.8	15.6
5.0	300	0.8	16.4
	310	0.8	17.3
	320	0.8	18.1
	330	0.8	18.9
	340	0.8	19.7
	350	1.0	20.7
6.0	360	1.0	21.6
	370	1.0	22.6
	380	1.0	23.5
	390	1.0	24.5
	400	1.0	25.4
	410	1.3	26.8

Time (hours)	Time (minutes)	Percent Rainfall	Cumulative Percent Rainfall
7.0	420	1.3	28.1
	430	1.3	29.4
	440	1.8	31.2
	450	1.8	33.0
	460	3.4	36.4
	470	5.4	41.8
8.0	480	2.7	44.5
	490	1.8	46.3
	500	1.3	47.7
	510	1.3	49.0
	520	1.3	50.4
	530	0.9	51.2
9.0	540	0.9	52.1
	550	0.9	53.0
	560	0.9	53.9
	570	0.9	54.8
	580	0.9	55.6
	590	0.9	56.5
10.0	600	0.9	57.4
	610	0.9	58.3
	620	0.9	59.2
	630	0.9	60.0
	640	0.9	60.9
	650	0.7	61.6
11.0	660	0.7	62.4
	670	0.7	63.1
	680	0.7	63.8
	690	0.7	64.5
	700	0.7	65.2
	710	0.7	66.0
12.0	720	0.7	66.7
	730	0.7	67.4
	740	0.7	68.1
	750	0.7	68.8
	760	0.7	69.6
	770	0.6	70.1
13.0	780	0.6	70.7
	790	0.6	71.3
	800	0.6	71.8
	810	0.6	72.4
	820	0.6	73.0
	830	0.6	73.6

24-Hour Design Storm Hyetograph Values, continued

Time (hours)	Time (minutes)	Percent Rainfall	Cumulative Percent Rainfall
14.0	840	0.6	74.1
	850	0.6	74.7
	860	0.6	75.3
	870	0.6	75.8
	880	0.6	76.4
	890	0.5	76.9
15.0	900	0.5	77.4
	910	0.5	77.9
	920	0.5	78.4
	930	0.5	78.9
	940	0.5	79.4
	950	0.5	79.9
16.0	960	0.5	80.4
	970	0.5	80.9
	980	0.5	81.4
	990	0.5	81.9
	1000	0.5	82.4
	1010	0.4	82.8
17.0	1020	0.4	83.2
	1030	0.4	83.6
	1040	0.4	84.0
	1050	0.4	84.4
	1060	0.4	84.8
	1070	0.4	85.2
18.0	1080	0.4	85.6
	1090	0.4	86.0
	1100	0.4	86.4
	1110	0.4	86.8
	1120	0.4	87.2
	1130	0.4	87.6
19.0	1140	0.4	88.0
	1150	0.4	88.4
	1160	0.4	88.8
	1170	0.4	89.2
	1180	0.4	89.6
	1190	0.4	90.0
20.0	1200	0.4	90.4
	1210	0.4	90.8
	1220	0.4	91.2
	1230	0.4	91.6
	1240	0.4	92.0
	1250	0.4	92.4

Time (hours)	Time (minutes)	Percent Rainfall	Cumulative Percent Rainfall
21.0	1260.0	0.4	92.8
	1270.0	0.4	93.2
	1280.0	0.4	93.6
	1290.0	0.4	94.0
	1300.0	0.4	94.4
	1310.0	0.4	94.8
	1320.0	0.4	95.2
22.0	1330.0	0.4	95.6
	1340.0	0.4	96.0
	1350.0	0.4	96.4
	1360.0	0.4	96.8
	1370.0	0.4	97.2
	1380.0	0.4	97.6
23.0	1390.0	0.4	98.0
	1400.0	0.4	98.4
	1410.0	0.4	98.8
	1420.0	0.4	99.2
	1430.0	0.4	99.6
	1440.0	0.4	100.0

## Appendix 2-B

### WWHM – Information, Assumptions and Computation Steps for WWHM3





## Western Washington Hydrology Model – Information, Assumptions, and Computation Steps for WWHM3

This appendix describes some of the information and assumptions used in the Western Washington Hydrology Model, Version 3 (WWHM3).

However, since the first version of WWHM was developed and released to public in 2001, WWHM program has gone through several upgrades incorporating new features and capabilities. WWHM 2012 has added low impact development (LID) modeling capability. LID flow modeling guidance for both WWHM3 and WWHM 2012 is given in Appendix 2-C of this manual. WWHM users should periodically check Ecology’s WWHM web site for the latest releases of WWHM, user manual, and any supplemental instructions. The web address is: <http://www.ecy.wa.gov/programs/wq/stormwater/whmtraining/index.html>.

### WWHM Limitations

WWHM has been created for the specific purpose of sizing stormwater control facilities for new development and redevelopment projects in Western Washington. WWHM can be used for a range of conditions and developments; however, certain limitations are inherent in this software. These limitations are described below.

The WWHM uses the EPA HSPF software program to do all of the rainfall-runoff and routing computations. Therefore, HSPF limitations are included in the WWHM. For example, HSPF does not explicitly model backwater or tailwater control situations. This is also true in the WWHM.

### WWHM Information and Assumptions

#### 1. Precipitation data.

##### Length of record.

The WWHM uses long-term (50 - 70 years) precipitation data to simulate the potential impacts of land use development in western Washington. A minimum period of 20 years is sufficient to simulate enough peak flow events to produce accurate flow frequency results. A 40 to 50-year record is preferred. The actual length of record of each precipitation station varies, but all exceed 50 years.

##### Rainfall distribution.

The precipitation data are representative of the different rainfall regimes found in western Washington. More than 17 precipitation stations are used. These stations represent rainfall at elevations below 1500 feet. WWHM does not include snowfall and melt.

The primary source for precipitation data is National Weather Service stations. The secondary source is precipitation data collected by local jurisdictions. During development of WWHM, county engineers at 19 western Washington counties were contacted to obtain local precipitation data.

Earlier versions of the WWHM used hourly data from the precipitation stations in the table below to generate precipitation timeseries for use in WWHM. For WWHM 2012, more recent precipitation data have been used to generate precipitation timeseries in 15-minute time steps.

Precipitation Station	Years of Data	County Coverage
Astoria, OR	1955-1998 = 43	Wahkiakum
Blaine	1948-1998 = 50	Whatcom, San Juan
Burlington	1948-1998 = 50	Skagit, Island
Clearwater	1948-1998 = 50	Jefferson (west)
Darrington	1948-1996 = 48	Snohomish (northeast)
Everett	1948-1996 = 48	Snohomish (excluding northeast)
Frances	1948-1998 = 50	Pacific
Landsburg	1948-1997 = 49	King (east)
Longview	1955-1998 = 43	Cowlitz, Lewis (south)
McMillian	1948-1998 = 50	Pierce
Montesano	1955-1998 = 43	Grays Harbor
Olympia	1955-1998 = 43	Thurston, Mason (south), Lewis (north)
Port Angeles	1948-1998 = 50	Clallam (east)
Portland, OR	1948-1998 = 50	Clark, Skamania
Quilcene	1948-1998 = 50	Jefferson (east), Mason (north), Kitsap
Sappho	1948-1998 = 50	Clallam (west)
SeaTac	1948-1997 = 49	King (west)

The records were reviewed for length, quality, and completeness of record. Annual totals were checked along with hourly maximum totals. Using these checks, data gaps and errors were corrected, where possible. A "Quality of Record" summary was produced for each precipitation record reviewed.

The reviewed and corrected data were placed in multiple WDM (Watershed Data Management) files. One WDM file was created per county and contains all of the precipitation data to be used by the WWHM for that particular county. A local government that believes that it has a more accurate precipitation record to use with the WWHM should petition Ecology to allow use of that record, and to possibly incorporate that record into the WWHM. This may be more easily done in the future if the WWHM is upgraded to allow use of custom precipitation time series.

Computational time step.

The computational time step used in the earlier versions of WWHM has been one hour. The one-hour time step was selected to better represent the temporal variability of actual precipitation than daily data. WWHM 2012l incorporates 15-minute precipitation time series.

## 2. Precipitation multiplication factors.

Precipitation multiplication factors increase or decrease recorded precipitation data to better represent local rainfall conditions. This is particularly important when the precipitation gage is located some distance from the study area.

Precipitation multiplication factors were developed for western Washington. The factors are based on the ratio of the 24-hour, 25-year rainfall intensities for the representative precipitation gage and the surrounding area represented by that gage's record. The 24-hour, 25-year rainfall intensities were determined from the NOAA Atlas 2 (*Precipitation-Frequency Atlas of the Western United States, Volume IX – Washington, 1973*).

These multiplication factors were created for the Puget Sound lowlands plus all western Washington valleys and hillside slopes below 1500 feet elevation. The factors were placed in the WWHM database and linked to each county's map. They are transparent to the general user and the default range is set to 0.8 – 2. The advanced user will have the ability to change the precipitation multiplication factor for a specific site. However, such changes will be recorded in the WWHM output.

## 3. Pan evaporation data.

Pan evaporation data are used to determine the potential evapotranspiration (PET) of a study area. Actual evapotranspiration (AET) is computed by the WWHM based on PET and available moisture supply. AET accounts for the precipitation that returns to the atmosphere without becoming runoff. Soil moisture conditions and runoff are directly influenced by PET and AET.

Evaporation is not highly variable like rainfall. Puyallup pan evaporation data are used for all of the 19 western Washington counties.

Pan evaporation data were assembled and checked for the same time period as the precipitation data and placed in the appropriate county WDM files.

Pan evaporation data are collected in the field, but PET is used by the WWHM. PET is equal to pan evaporation times a pan evaporation coefficient. Depending on climate, pan evaporation coefficients for western Washington range from 0.72 to 0.82.

NOAA Technical Report NWS 33, *Evaporation Atlas for the Contiguous 48 United States*, was used as the source for the pan evaporation coefficients. Pan evaporation coefficient values are shown on Map 4 of that publication.

As with the precipitation multiplication factors, the pan evaporation coefficients have been placed in the WWHM database and linked to each county's map. They will be transparent to the general user. The advanced user will have the ability to change the coefficient for a specific site. However, such changes will be recorded in the WWHM output.

#### **4. Soil data.**

Soil type, along with vegetation type, greatly influences the rate and timing of the transformation of rainfall to runoff. Sandy soils with high infiltration rates produce little or no surface runoff; almost all runoff is from ground water. Soils with a compressed till layer slowly infiltrate water and produce larger amounts of surface runoff during storm events.

WWHM uses three predominant soil types to represent the soils of western Washington: till, outwash, and saturated

Till soils have been compacted by glacial action. Under a layer of newly formed soil lies a compressed soil layer commonly called "hardpan". This hardpan has very poor infiltration capacity. As a result, till soils produce a relatively large amount of surface runoff and interflow. A typical example of a till soil is an Alderwood soil (SCS class C). Where field infiltration tests indicate a measured initial infiltration rate less than 0.30 in/hr., the user may model the site as a class C soil.

Outwash soils have a high infiltration capacity due to their sand and gravel composition. Outwash soils have little or no surface runoff or interflow. Instead, almost all of their runoff is in the form of ground water. An Everett soil (SCS class A) is a typical outwash soil.

Outwash soils over high ground water or an impervious soil layer have low infiltration rates and act like till soils. Where ground water or an impervious soil layer is within 5 feet from the surface, outwash soils may be modeled as till soils in the WWHM.

Saturated soils are usually found in wetlands. They have a low infiltration rate and a high ground water table. When dry, saturated soils have a high storage capacity and produce very little runoff. However, once they become saturated they produce surface runoff, interflow, and ground water in large quantities. Mukilteo muck (SCS class D) is a typical saturated/wetland soil.

The user will be required to investigate actual local soil conditions for the specific development planned. The user will then input the number of acres of outwash (A/B), till (C/D), and saturated/wetland soils for the site conditions.

Alluvial soils are found in valley bottoms. These are generally fine-grained and often have a high seasonal water table. There has been relatively little experience in calibrating the HSPF model to runoff from these soils, so in the absence of better information, these soils may be modeled as till soils.

Additional soils will be included in the WWHM if appropriate HSPF parameter values are found to represent other major soil groups.

The three predominant soil types are represented in the WWHM by specific HSPF parameter values that represent the hydrologic characteristics of these soils. More information on these parameter values is presented below.

#### **5. Vegetation data.**

As with soil type, vegetation types greatly influence the rate and timing of the transformation of rainfall to runoff. Vegetation intercepts precipitation, increases its ability to percolate through the soil, and evaporates and transpires large volumes of water that would otherwise become runoff.

WWHM represents the vegetation of western Washington with three predominant vegetation categories: forest, pasture, and lawn (also known as grass).

Forest vegetation represents the typical second growth Douglas fir found in the Puget Sound lowlands. Forest has a large interception storage capacity. This means that a large amount of precipitation is caught in the forest canopy before reaching the ground and becoming available for runoff. Precipitation intercepted in this way is later evaporated back into the atmosphere. Forest also has the ability to transpire moisture from the soil via its root system. This leaves less water available for runoff.

Pasture vegetation is typically found in rural areas where the forest has been cleared and replaced with shrub or grass lots. Some pasture areas may be used to graze livestock. The interception storage and soil evapotranspiration capacity of pasture are less than forest. Soils may have also been compressed by mechanized equipment during clearing activities. Livestock can also compact soil. Pasture areas typically produce more runoff (particularly surface runoff and interflow) than forest areas.

Lawn vegetation is representative of the suburban vegetation found in typical residential developments. Soils have been compacted by earth moving equipment, often with a layer of topsoil removed. Sod and ornamental bushes replace native vegetation. The interception storage and evapotranspiration of lawn vegetation is less than pasture, more runoff results.

Predevelopment default land conditions are forest, although the user has the option of specifying pasture if there is documented evidence that pasture vegetation was native to the predevelopment site. If this option is used, the change will be recorded in the WWHM output.

Forest vegetation is represented by specific HSPF parameter values that represent the forest hydrologic characteristics. As described above, the existing regional HSPF parameter values for forest are based on undisturbed second-growth Douglas fir forest found today in western Washington lowland watersheds.

Postdevelopment vegetation will reflect the new vegetation planned for the site. The user has the choice of forest, pasture, and landscaped vegetation. Forest and pasture are only appropriate for postdevelopment vegetation in parcels separate from standard residential or non-standard residential/commercial developments. Development areas must only be designated as forest or pasture where legal restrictions can be documented that protect these areas from future disturbances. WWHM assumes the pervious land portion of developed areas is covered with lawn vegetation, as described above.

## **6. Development land use data.**

The WWHM user must enter land use information for the pre-developed condition and the proposed development condition into the model. WWHM users must select the appropriate land use category and slope, where slope of 0-5% is flat, 5-15% is moderate, and greater than 15% is steep. The land use categories include: Impervious areas such as Roads, Roof, Driveways, Sidewalks, Parking, Ponds; and Pervious areas such as Lawn (this includes lawn, garden, areas with ornamental plants, and any natural areas not legally protected from future disturbance), Forest, and Pasture. The soils types available are A/B (outwash), C (Till), and Saturated (wetland).

Forest and pasture vegetation areas are only appropriate for separate undeveloped parcels dedicated as open space, wetland buffer, or park within the total area of the standard residential development. ***Development areas must only be designated as forest or pasture where legal restrictions can be documented that protect these areas from future disturbances.***

Impervious, as the name implies, allows no infiltration of water into the pervious soil. All runoff is surface runoff. Impervious land typically consists of paved roads, sidewalks, driveways, and parking lots. Roofs are also impervious.

For the purposes of hydrologic modeling, only effective impervious area is categorized as impervious. Effective impervious area (EIA) is the area where there is no opportunity for surface runoff from an impervious site to infiltrate into the soil before it reaches a conveyance system (pipe, ditch, stream, etc.). An example of an EIA is a shopping center parking lot where the water runs off the pavement and directly goes into a catch basin where it then flows into a pipe and eventually to a stream. In contrast, some homes with impervious roofs collect the roof runoff into roof gutters and send the water down downspouts. When the water reaches the base of the downspout it can be directed into an infiltration system. If roof runoff is infiltrated according to the requirements of BMP T5.10A or B, the roof area can be considered ineffective impervious area. The roof area may then be discounted from the project area entered into WWHM.

The non-effective impervious area uses the adjacent or underlying soil and vegetation properties. Vegetation often varies by the type of land use. The assumption is made in the WWHM that the EIA equals the TIA (total impervious area). This is consistent with King County's determination of EIA acres for new developments. Where appropriate, the TIA can be reduced through the use of runoff credits (more on that below).

Earlier versions of WWHM (WWHM1 and WWHM2) provided the 2 optional features below for modeling of Standard Residential development and obtaining flow credits for incorporating low impact development (LID) techniques. Later upgrades to WWHM have provided for direct input of the standard residential development details by the WWHM users. WWHM 2012 enables direct modeling of some LID techniques through use of new LID Elements. Other LID techniques will continue to be modeled in accordance with Appendix 2-C of this manual.

**Standard Residential:** For housing developments where lot-specific details (e.g., size of roof and driveway) are not yet determined, the earlier versions of WWHM provided a set of default assumptions about the amount of impervious area per lot and its division between driveways and rooftops under the "Standard Residential" development land use type. Later versions of WWHM (e.g., WWHM3, WWHM 2012) do not have this option programmed in the model but the land use assumptions for the "Standard Residential" development are given below.

Ecology has selected a standard impervious area of 4200 square feet per residential lot, with 1000 square feet of that as driveway, walkways, and patio area, and the remainder as rooftop area. The rest of the lot acres will be assumed to be landscaped area (including lawn). The user inputs the number of residential lots and the total acreage of the residential lots (public right-of-way acreages and non-residential lot acreages excluded). The number of residential lots and the associated number of acres will be used to compute the average number of residential lots per acre. This value together with the number of residential lots and the impervious area in the public right-of-way will be used by the model to calculate the TIA for the proposed development. The areas covered by streets, parking areas, and sidewalk areas are input separately by the user.

**Runoff Credits:** Please note that the modeling of runoff credits using some of the low impact development techniques described in Appendix 2-C have been updated. WWHM 2012 provides LID modeling capabilities in accordance with this manual. The following LID credit modeling is based on modeling in earlier versions of WWHM (WWHM2 and WWHM3).

Runoff credits can be obtained using any or all of the low impact development methods listed below. The WWHM has an automated procedure for taking credits for infiltrating or dispersing roof runoff - methods #1 and #2 below. Credits for using methods 3,4,8, and 9 must be taken by following the guidance in Appendix 2-C. Methods 5, 6, and 10 also have guidance in Appendix 2-C for taking credits. However, the new LID Elements in WWHM 2012 allow direct modeling of methods 4, 5, 6, and 10 and would better represent how they function to reduce surface runoff. Roof areas using method 7 - rainwater harvesting systems designed in accordance with the guidance in Appendix 2-C need not be entered into the model. Also, if using method 11 – full dispersion – the runoff model need not be used for the area that meets the criteria in Appendix 2-C.

1. Infiltrate roof runoff
2. Disperse roof runoff
3. Disperse driveway and other hard surface runoff
4. Porous pavement for driveways and walks
5. Porous pavement for roads and parking lots
6. Vegetated Roofs
7. Rainwater Harvesting
8. Reverse slope sidewalks
9. Low impact foundations
10. Bioretention Areas
11. Full dispersion

#### 1. Infiltrate Roof Runoff

Credit is given for disconnecting the roof runoff from the development's stormwater conveyance system and infiltrating on the individual residential lots. The WWHM assumes that this infiltrated roof runoff does not contribute to the runoff flowing to the stormwater detention pond site. It disappears from the system and does not have to be mitigated.

#### 2. Disperse Roof Runoff

Credit is also given for disconnecting the roof runoff from the development's stormwater conveyance system and dispersing it on the lawn/landscaped surface of individual lots. If the runoff is dispersed using a dispersion trench on single-family lots greater than 22,000 square feet, and the vegetative flow path of the runoff is 50 feet or longer through undisturbed native or compost-amended soils, the roof area can be entered into the model as landscaped area rather than impervious surface.

### 3. Disperse driveway and other hard surface runoff:

If runoff is dispersed in accordance with the guidance in BMP T5.11 or BMP T5.12, the driveway or other hard surface may be modeled as landscaped area.

### 4. & 5. Permeable pavement

The third option for runoff credit is the use of permeable pavement for private driveways, sidewalks, streets, and parking areas. The LID credit guidance in Appendix 2-C was developed before WWHM 2012, with the capability of directly modeling permeable pavements, became available. The LID credit guidance in Appendix 2-C will direct you to enter a certain percentage of the pervious pavement area into the landscaped area category rather than the street/sidewalk/parking lot category. Even though WWHM 2012 has other methods for calculating the impacts of permeable pavement, the methods described in Part 1 are appropriate to use where the permeable pavement does not have a significant depth of base course for storage.

Follow similar procedures for vegetated roofs, reverse slope sidewalks, and low impact foundations. The LID credit guidance of Appendix 1-F directs how these surfaces should be entered into the model. If you do not know the specific quantities of the different land cover types for your development (e.g., the individual lots will be sold to builders who will determine layout and size of home), you should start with the assumption of 4200 sq. ft. of impervious area per lot – including 1,000 sq. ft. for driveways, and begin making adjustments in those totals as allowed in the LID guidance of Appendix 1-F.

### Other Development Options and Model Features

WWHM allows the flexibility of bypassing a portion of the development area around a flow control facility and/or having off-site inflow that is entering the development area pass through the flow control facility.

Bypass occurs when a portion of the development does not drain to a stormwater detention facility. On-site runoff from a proposed development project may bypass the flow control facility provided that all of the following conditions are met.

1. Runoff from both the bypass area and the flow control facility converges within a quarter-mile downstream of the project site discharge point.
2. The flow control facility is designed to compensate for the uncontrolled bypass area such that the net effect at the point of convergence downstream is the same with or without bypass.
3. The 100-year peak discharge from the bypass area will not exceed 0.4 cfs.
4. Runoff from the bypass area will not create a significant adverse impact to downstream drainage systems or properties.
5. Water quality requirements applicable to the bypass area are met.

Off-site Inflow occurs when an upslope area outside the development drains to the flow control facility in the development. The bypass of off-site runoff must be designed so as to achieve both of the following:

1. Any existing contribution of flows to an on-site wetland must be maintained.



2. Off-site flows that are naturally attenuated by the project site under predeveloped conditions must remain attenuated, either by natural means or by providing additional on-site detention so that peak flows do not increase.

#### Application of WWHM in Re-developments Projects

WWHM allows only forest or pasture as the predevelopment land condition in the Design Basin screen. This screen does not allow other types of land uses such as impervious and landscaped areas to be entered for existing condition. However, WWHM can be used for redevelopment projects by modeling the existing developed areas that are not subject to the flow control requirements of Book 1 as off-site areas. For the purposes of predicting runoff from such an existing developed area, enter the existing area in the Off-site Inflow screen. This screen is designed to predict runoff from impervious and landscaped areas in addition to the forest and pasture areas. If the existing 100-year peak flow rate from the existing developed areas that are not subject to flow control is greater than 50% of the 100-year developed peak flow rate (undetained but subject to the flow control requirements of Book 1), then the runoff from the off-site area must not be allowed to flow to the on-site flow control facility.

#### **7. PERLND and IMPLND parameter values.**

In WWHM (and HSPF) pervious land categories are represented by PERLNDs; impervious land categories (EIA) by IMPLNDs. An example of a PERLND is a till soil covered with forest vegetation. This PERLND has a unique set of HSPF parameter values. For each PERLND there are 16 parameters that describe various hydrologic factors that influence runoff. These range from interception storage to infiltration to active ground water evapotranspiration. Only four parameters are required to represent IMPLND.

PERLND parameters:

LZSN = lower zone storage nominal (inches)  
INFILT = infiltration capacity (inches/hour)  
LSUR = length of surface overland flow plane (feet)  
SLSUR = slope of surface overland flow plane (feet/feet)  
KVARY = ground water exponent variable (inch<sup>-1</sup>)  
AGWRC = active ground water recession constant (day<sup>-1</sup>)  
INFEXP = infiltration exponent  
INFILD = ratio of maximum to mean infiltration  
BASETP = base flow evapotranspiration (fraction)  
AGWETP = active ground water evapotranspiration (fraction)  
CEPSC = interception storage (inches)  
UZSN = upper zone storage nominal (inches)  
NSUR = roughness of surface overland flow plane (Manning's n)  
INTFW = interflow index  
IRC = interflow recession constant (day-1)  
LZETP = lower zone evapotranspiration (fraction)

A more complete description of these PERLND parameters is found in the HSPF User Manual (Bicknell et al, 1997).

PERLND parameter values for other additional soil/vegetation categories will be investigated and added to the WWHM, as appropriate.

#### IMPLND Parameters

	EIA
Name	
LSUR	400
SLSUR	0.01
NSUR	0.10
RETSC	0.10

#### IMPLND parameters:

LSUR = length of surface overland flow plane (feet)

SLSUR = slope of surface overland flow plane (feet/feet)

NSUR = roughness of surface overland flow plane (Manning's n)

RETSC = retention storage (inches)

A more complete description of these IMPLND parameters is found in the HSPF User Manual (Bicknell et al, 1997).

The PERLND and IMPLND parameter values will be transparent to the general user. The advanced user will have the ability to change the value of a particular parameter for that specific site. However, the only PERLND and IMPLND parameters that are authorized to be adjusted by the user are LSUR, SLSUR, and NSUR. These are parameters whose values are observable at an undeveloped site, and whose values can be reasonably estimated for the proposed development site. Any such changes will be recorded in the WWHM output.

Earlier versions of WWHM (WWHM1 and WWHM2) provided only one category of moderate land slope (typically 5-15% slopes). In more recent versions of WWHM (WWHM3 and WWHM 2012), two additional land categories have been added to account for the flat (0-5%) and steep (15-25%) land slopes.

Surface runoff and interflow will be computed based on the PERLND and IMPLND parameter values. Ground water flow can also be computed and added to the total runoff from a development if there is a reason to believe that ground water would be surfacing (such as where there is a cut in a slope). However, the default condition in WWHM assumes that no ground water flow from small catchments reaches the surface to become runoff. This is consistent with King County procedures (King County, 1998).

### **8. Guidance for flow-related standards.**

Use flow-related standards to determine whether or not a proposed stormwater facility will provide a sufficient level of mitigation for the additional runoff from land development. Guidance is provided on the standards that must be met to comply with the Minimum Requirements.

There are three flow-related standards stated in Book 1: Minimum Requirement #5 - On-site Stormwater Management; Minimum Requirement #7 - Flow Control and Minimum Requirement #8 - Wetlands Protection.

Minimum Requirement #5 allows the user to demonstrate compliance with the LID Performance Standard of matching developed discharge durations to pre-developed durations for the range of pre-developed discharge rates from 8% of the 2-year peak flow to 50% of the 2-year peak flow. If the post-development flow duration values exceed any of the predevelopment flow levels between 8% and 50% of the 2-year predevelopment peak flow values, then the LID performance standard not been met.

Minimum Requirement #7 specifies that stormwater discharges to streams shall match developed discharge durations to predeveloped durations for the range of predeveloped discharge rates from 50% of the 2-year peak flow up to the full 50-year peak flow. In general, matching discharge durations between 50% of the 2-year and 50-year will result in matching the peak discharge rates in this range.

WWHM uses the predevelopment peak flow value for each water year to compute the predevelopment 2- through 100-year flow frequency values. The postdevelopment runoff 2- through 100-year flow frequency values are computed from the outlet of the proposed stormwater facility. The user must enter the stage-surface area-storage-discharge table (HSPF FTABLE) for the stormwater facility. The model then routes the postdevelopment runoff through the stormwater facility. As with the predevelopment peak flow values, the model will select the maximum developed flow value for each water year to compute the developed 2- through 100-year flow frequency.

The actual flow frequency calculations are made using the federal standard Log Pearson Type III distribution described in Bulletin 17B (United States Water Resources Council, 1981). This standard flow frequency distribution is provided in U.S. Geological Survey program J407, version 3.9A-P, revised 8/9/89. The Bulletin 17B algorithms in program J407 are included in the WWHM calculations.

Minimum Requirement #7 is based on flow duration. WWHM will use the entire predevelopment and post-development runoff record to compute flow duration. The standard requires that post-development runoff flows must not exceed the flow duration values of the predevelopment runoff between the predevelopment flow values of 50 percent of the 2-year flow and 100 percent of the 50-year flow.

Flow duration is computed by counting the number of flow values that exceed a specified flow level. The specified flow levels used by WWHM in the flow duration analysis are listed below.

1. 50% of the 2-year predevelopment peak flow.
2. 100% of the 2-year predevelopment peak flow.
3. 100% of the 50-year predevelopment peak flow.

In addition, flow durations are computed for 97 other incremental flow values between 50 percent of the 2-year predevelopment peak flow and 100 percent of the 50-year predevelopment peak flow.

There are three criteria by which flow duration values are compared:

1. If the postdevelopment flow duration values exceed any of the predevelopment flow levels between 50% and 100% of the 2-year predevelopment peak flow values (100 Percent Threshold) then the flow duration requirement has not been met.

2. If the postdevelopment flow duration values exceed any of the predevelopment flow levels between 100% of the 2-year and 100% of the 50-year predevelopment peak flow values more than 10 percent of the time (110 Percent Threshold) then the flow duration requirement has not been met.
3. If more than 50 percent of the flow duration levels exceed the 100 percent threshold then the flow duration requirement has not been met.

The results are provided in the WWHM report.

Minimum Requirement #8 specifies that total discharges to wetlands must not deviate by more than 20% on a daily basis, and must not deviate by more than 15% on a monthly basis. Flow components feeding the wetland under both Pre-and Post-development scenarios are assumed to be the sum of the surface, interflow, and ground water flows from the project site. The WWHM is being revised to more easily allow this comparison.

## References for Western Washington Hydrology Model

Beyerlein, D.C. 1996. Effective Impervious Area: The Real Enemy. Presented at the Impervious Surface Reduction Research Symposium, The Evergreen State College. Olympia, WA.

Bicknell, B.R., J.C. Imhoff, J.L. Kittle Jr, A.S. Donigian Jr, and R.C. Johanson. 1997. Hydrological Simulation Program – Fortran User's Manual for Version 11. EPA/600/R-97/080. National Exposure Research Laboratory. Office of Research and Development. U.S. Environmental Protection Agency. Research Triangle Park, NC.

Dinicola, R.S. 1990. Characterization and Simulation of Rainfall-Runoff Relations for Headwater Basins in Western King and Snohomish Counties, Washington. Water-Resources Investigations Report 89-4052. U.S. Geological Survey. Tacoma, WA.

King County. 1998. Surface Water Design Manual. Department of Natural Resources. Seattle, WA.

United States Water Resources Council. 1981. Guidelines for Determining Flood Flow Frequency. Bulletin #17B of the Hydrology Committee. Washington, DC.

This page left blank intentionally

## Appendix 2-C

### Low Impact Development Flow Modeling

This page is left blank intentionally



# Washington State Department of Ecology Low Impact Development Flow Modeling Guidance

Clark County requires the use of the Western Washington Hydrology Model (WWHM) and other approved runoff model for estimating surface runoff and sizing stormwater control and treatment facilities. Clark County allows use of either the previous version of WWHM, WWHM 3, or the current version, WWHM 2012.

Part 1 of this appendix explains how to represent various LID techniques within WWHM 3 so that their benefit in reducing surface runoff can be estimated. The lower runoff estimates should translate into smaller stormwater treatment and flow control facilities. In certain cases, use of various techniques can result in the elimination of those facilities.

Part 2 of this appendix discusses direct modeling of some LID techniques in the WWHM 2012 version, which better represents how these techniques function to reduce runoff.

As Puget Sound gains more experience with and knowledge of LID techniques, the design criteria will evolve. Also, our ability to model their performance will change as our modeling techniques improve. Therefore, we anticipate this guidance will be updated periodically to reflect the new knowledge and modeling approaches.

## Part 1: Guidance for Use with WWHM 3

### C.1 Permeable Pavements

#### C.1.1 Porous Asphalt or Concrete

<u>Description</u>	<u>Model Surface as</u>
1. Base material laid above surrounding grade:	
a) Without underlying perforated drain pipes to collect stormwater	Grass over underlying soil type (till or outwash)
b) With underlying perforated drain pipes for stormwater collection:	
at or below bottom of base layer	Impervious surface
elevated within the base course	Impervious surface
2. Base material laid partially or completely below surrounding grade:	
a) Without underlying perforated drain pipes underlying soil type	Option 1: Grass over

Option 2: Impervious surface  
routed to a Gravel  
Trench/Bed<sup>1</sup>

- b) With underlying perforated drain pipes:  
at or below bottom of base layer  
elevated within the base course<sup>2</sup>

Impervious surface  
Model as impervious surface routed  
to a Gravel Trench/Bed<sup>1</sup>

### C.1.2 Grid/lattice systems (non-concrete) and Paving Blocks

#### Description

#### Model Surface as

#### 1. Base material laid above surrounding grade

- a) Without underlying perforated drain pipes

Grid/lattice systems: grass on  
underlying soil (till or outwash).  
Paving Blocks: 50% grass on  
underlying soil; 50% impervious.

- b) With underlying perforated drain pipes

Impervious surface

#### 2. Base material laid partially or completely below surrounding grade

- a) Without underlying perforated drain pipes

Option 1:  
Grid/lattice as grass on underlying soil.  
Paving blocks as 50% grass; 50% impervious.  
Option 2:  
Impervious surface routed to a Gravel  
Trench/Bed.<sup>1</sup>

- b) With underlying perforated drain pipes  
at or below bottom of base layer  
elevated within the base course<sup>2</sup>

Impervious surface  
Model as impervious surface routed to a  
Gravel Trench/Bed.<sup>1</sup>

## C.2 Dispersion

### C.2.1 Full Dispersion for the Entire Development Site

Residential Developments that implement [BMP T5.30](#) do not have to use approved runoff models to demonstrate compliance. They are assumed to fully meet the treatment and flow control requirements.

---

<sup>1</sup> See section C.11 for detailed instructions concerning how to represent the base material below grade as a gravel trench/bed in the Western Washington Hydrology Model.

<sup>2</sup> If the perforated pipes function is to distribute runoff directly below the wearing surface, and the pipes are above the surrounding grade, follow the directions for 2a above.

### *C.2.2 Full Dispersion for Part of the Development Site*

Those portions of residential developments that implement [BMP T5.30](#) do not have to use approved runoff models to demonstrate compliance. They are assumed to fully meet the treatment and flow control requirements.

### *C.2.3 Partial Dispersion on residential lots and commercial buildings*

If roof runoff is dispersed on single-family lots or commercial lots according to the design criteria and guidelines in [BMP T5.10C](#) in Book 2 through undisturbed native landscape or lawn/landscape area that meets the guidelines in [BMP T5.13](#) in Book 2, the user has two options.

Option 1: The roof area may be modeled as landscaped area if the vegetated flow path is 50 feet or more. Do this in WWHM on the Mitigated Scenario screen by entering the roof area into one of the entry options for dispersal of impervious area runoff. Alternately, enter the roof area as landscaped area with the appropriate landscaped slope. Where the flow path is between 25 and 50 feet and a dispersion trench is used, the roof area may be modeled as 50% landscape/50% impervious. Do this in WWHM on the Mitigated Scenario screen by entering 50% of the roof area as impervious and the other 50% as landscaped area.

Option #2: The user may apply the “lateral flow icons.” In this option, the “Lateral Flow Impervious Area” icon is used to represent the roof area(s). That icon is then connected to a “Lateral Flow Basin” icon that represents the pervious area into which the roof is being dispersed. The user should direct surface runoff and interflow from the “lateral flow basin” to a treatment system, retention/detention basin, or directly to a point of compliance.

Whether option #1 or #2 is used, the vegetated flow path is measured from the downspout or dispersion system discharge point to the downgradient edge of the vegetated area. That flow path must be at least 50 feet unless a dispersion trench is used with a vegetated flow path of 25 to 50 feet.

Where [BMP T5.11](#) (concentrated flow dispersion) or [BMP T5.12](#) (sheet flow dispersion) in Book 2 is used to disperse runoff from impervious areas other than roofs into a native vegetation area or an area that meets the guidelines in [BMP T5.13](#) in Book 2, the same two options as described above are available. The user may model the impervious area as landscaped area (50 feet or more of vegetated flow path), 50% landscape/50% impervious (25 to 50 feet of vegetated flow path), or the “lateral flow” icons may be used. As above, the vegetated flow path from the dispersal point to the downgradient edge of the vegetated area must be at least 50 feet, unless a dispersion trench is used with a vegetated flow path of 25 to 50 feet.

## **C.3 Downspout Full Infiltration**

Roof areas served by downspouts that drain to infiltration dry wells or infiltration trenches that are sized in accordance with the guidance in [BMP T5.10A](#) and [BMP T5.10B](#) do not have to be entered into the runoff model. They are assumed to fully infiltrate the roof runoff.

## **C.4 Vegetated Roofs**

### *C.4.1 Option 1 Design Criteria*

- 3 inches to 8 inches of soil/growing media

Runoff Model Representation

- 50% till landscaped area; 50% impervious area

#### C.4.2 Option 2 Design Criteria

- $\geq 8$  inches of soil/media

#### Runoff Model Representation

- 50% till pasture; 50% impervious area

### C.5 Rainwater Harvesting

Do not enter drainage area into the runoff model.

*Note:* This applies only to drainage areas for which a monthly water balance indicates no overflow of the storage capacity.

### C.6 Reverse Slope Sidewalks

- Enter sidewalk area as landscaped area over the underlying soil type.
- Alternatively, use the “lateral flow” icons. Use the “Lateral Flow Impervious Area” icon for the sidewalk, and use the “Lateral Flow Basin” icon for the downgradient vegetated area.

### C.7 Minimal Excavation Foundations

- Where residential roof runoff is dispersed on the upgradient side of a structure in accordance with the design criteria and guidelines in [BMP T5.10BC](#) of ~~Volume III – Chapter 3, [Book 2](#)~~, the tributary roof area may be modeled as pasture on the native soil.
- In “step forming,” the building area is terraced in cuts of limited depth. This results in a series of level plateaus on which to erect the form boards. Where “step forming” is used on a slope, the square footage of roof that can be modeled as pasture must be reduced to account for lost soils. The following equation (suggested by Rick Gagliano of Pin Foundations, Inc.) can be used to reduce the roof area that can be modeled as pasture.

$$A_1 - \frac{dC(.5)}{dP} \times A_1 = A_2$$

$A_1$  = roof area draining to up gradient side of structure

$dC$  = depth of cuts into the soil profile

$dP$  = permeable depth of soil ( The A horizon plus an additional few inches of the B horizon where roots permeate into ample pore space of soil).

$A_2$  = roof area that can be modeled as pasture on the native soil. The rest of the roof is modeled as impervious surface unless it is dispersed in accordance with the next bullet.

- If roof runoff is dispersed downgradient of the structure in accordance with the design criteria and guidelines in [BMP T5.10C](#) of [Book 12](#), AND there is at least 50 feet of vegetated flow path through native material or lawn/landscape area that meets the guidelines in [BMP T5.13](#) of [Book 12](#), the tributary roof areas may be modeled as

landscaped area. Alternatively, use the lateral flow elements to send roof runoff onto the lawn/landscape area that will be used for dispersion.

### C.8 Tree Retention and Planting

#### C.8.1 Tree Retention Flow Control Credit

Flow control credits for retained trees are provided in [Table C.1](#) by tree type. These credits can be applied to reduce impervious or other hard surface area requiring flow control. Credits are given as a percentage of the existing tree canopy area. The minimum credit for existing trees ranges from 50 to 100 square feet.

**Table C.1  
Flow Control Credits for Retained Trees.**

Tree Type	Credit
Evergreen	20% of canopy area (minimum of 100 sq. ft./tree)
Deciduous	10% of canopy area (minimum of 50 sq. ft./tree)

Impervious Area Mitigated =  $\Sigma$  Canopy Area x Credit (%) / 100.

Tree credits are not applicable to trees in native vegetation areas used for flow dispersion or other flow control credit. Credits are also not applicable to trees in planter boxes. The total tree credit for retained and newly planted trees shall not exceed 25 percent of impervious or other hard surface requiring mitigation.

#### C.8.2 Newly Planted Tree Flow Control Credits

Flow control credits for newly planted trees are provided in [Table C.2](#) by tree type. These credits can be applied to reduce the impervious or other hard surface area requiring flow control. Credits range from 20 to 50 square feet per tree.

**Table C.2.  
Flow Control Credits for Newly Planted Trees.**

Tree Type	Credit
Evergreen	50 sq. ft. per tree
Deciduous	20 sq. ft. per tree

Impervious Area Mitigated =  $\Sigma$  Number of Trees x Credit (%) / 100.

Tree credits are not applicable to trees in native vegetation areas used for flow dispersion or other flow control credit. Credits are also not applicable to trees in planter boxes. The total tree credit for retained and newly planted trees shall not exceed 25 percent of impervious or other hard surface requiring mitigation.

### C.9 Soil Quality and Depth

All areas that meet the soil quality and depth requirement may be entered into the model as pasture rather than lawn/landscaping.

### C.10. Bioretention

#### C.10.1 Runoff Model Representation

##### Pothole design (bioretention cells)

Bioretention is represented by using the “Gravel trench/bed” icon with a steady-state infiltration rate. Proper infiltration rate selection is described below. The user inputs the dimensions of the gravel trench. Layer 1 on the input screen is the bioretention soil layer. Enter the soil depth and a porosity of 40%. Layer 2 is the free standing water above the bioretention soil. Enter the maximum depth of free standing water (i.e., up to the invert of an overflow pipe or a spillway, whatever engages first for surface release of water), and 100% for porosity. Bioretention with underlying perforated drain pipes that discharge to the surface can also be modeled as gravel trenches/beds with steady-state infiltration rates. However, the only volume available for storage (and modeled as storage as explained herein) is the void space within the imported material (usually sand or gravel) below the bioretention soil and below the invert of the drain pipe.

Using the procedures explained in Book 1, Section 2.2.1.3 and the test methods described in Book 1, Section 4.3.1.3, estimate the initial measured (a.k.a., short-term) infiltration rate of the native soils beneath the bioretention soil and any base materials. Because these soils are protected from fouling, no correction factor will be applied.

Facilities without and underdrain:

If using the default bioretention soil mix in accordance with [BMP T5.14B](#) in Book 2, 12 inches per hour is the initial infiltration rate. The long-term rate is either 3 inches per hour or 6 inches per hour depending upon the size of the drainage area and the use of a pretreatment device for solids removal prior to the bioretention facility. If using a custom imported soil mix other than the default, its saturated hydraulic conductivity (used as the infiltration rate) must be determined using the procedures described in [BMP T5.14B](#) in Book 2. The long-term infiltration rate is one-fourth or one-half of that rate depending upon the size of the drainage area and the use of a pretreatment device for solids removal.

Facilities with an elevated underdrain:

Note that only the estimated void space of the aggregate bedding layer that is below the invert of the underdrain pipe provides storage volume that provides a flow control benefit. Assume a 40% void volume for the Type 26 mineral aggregate specified in [BMP T5.14B](#).

Linear Design: (bioretention swale or slopes)

*Swales*

Where a swale design has a roadside slope and a back slope between which water can pond due to an elevated, and an overflow/drainage pipe at the lower end of the swale, the swale may be modeled as a gravel trench/bed with a steady state infiltration rate. This method does not apply to swales that are underlain by a drainage pipe.

If the long-term infiltration rate through the imported bioretention soil is lower than the infiltration rate of the underlying soil, the surface dimensions and slopes of the swale should be entered into the WWHM as the trench dimensions and slopes. The effective depth is the distance from the soil surface at the bottom of the swale to the invert of the overflow/drainage pipe. If the infiltration rate through the underlying soil is lower than the estimated long-term infiltration rate through the imported bioretention soil, the trench/bed dimensions entered into the WWHM should be adjusted to account for the storage volume in the void space of the bioretention soil. Use 40 percent porosity for bioretention planting mix soils recommended above for Layer 1 in WWHM.

This procedure to estimate storage space should only be used on bioretention swales with a 1% slope or less. Swales with higher slopes should more accurately compute the storage volume in the swale below the drainage pipe invert.

For a swale design with an underdrain, the directions above under Pothole design apply.

### *C.10.2 WWHM Routing and Runoff File Evaluation*

In WWHM3, all infiltrating facilities must have an overflow riser to model overflows that occur should the available storage be exceeded. So in the Riser/Weir screen, for the Riser head enter a value slightly smaller than the effective depth of the trench (say 0.1 ft below the Effective Depth); and for the Riser diameter enter a large number (say 10,000 inches) to ensure that there is ample capacity for overflows. The overflow should be routed to the point of compliance or a downstream facility. If the facility is underdrained, the underdrain must be similarly routed.

Within the model, route the runoff into the gravel trench by grabbing the gravel trench icon and placing it below the tributary “basin” area. Be sure to include the surface area of the bioretention area in the tributary “basin” area. Run the model to produce the effluent runoff file from the theoretical gravel trench. For projects subject to the flow control standard, compare the flow duration graph of that runoff file to the target pre-developed runoff file for compliance with the flow duration standard. If the standard is not achieved a downstream retention or detention facility must be sized (using the WWHM standard procedures) and located in the field. A conveyance system should be designed to route all overflows from the bioretention areas to centralized treatment facilities, and to flow control facilities if flow control applies to the project.

### *C.10.3 Modeling of Multiple Bioretention facilities*

Where multiple bioretention facilities are scattered throughout a development, it may be possible to cumulatively represent a group of them that have similar characteristics as one large bioretention facility serving the cumulative area tributary to those facilities. For this to be a reasonable representation, the design of each bioretention facility in the group should be similar (e.g., same depth of soil, same depth of surface ponded water, roughly the same ratio of impervious area to bioretention volume). In addition, the group should have similar (0.5x to 1.5x the average) controlling infiltration rates (i.e., either the long-term rate of the bioretention soil, or the initial rate of the underlying soil) that can be averaged as a single rate.

## **C.11 WWHM Instructions for Estimating Runoff Losses in Road Base Material Volumes that are Below Surrounding Grade**

### *Introduction*

This section applies to roads or parking lots that have been constructed with a permeable pavement and whose underlying base materials extend below the surrounding grade of land. The over-excavated volume can temporarily store water before it infiltrates or overflows to the surrounding ground surface. This section describes design criteria and modeling approaches for such designs.

### *Pre-requisite*

Before using this guidance to estimate infiltration losses, the designer should have sufficient information to know whether adequate depth to a seasonal high ground water table, or other

infiltration barrier (such as bedrock) is available. The minimum depth necessary is 3 feet as measured from the bottom of the base materials.

#### *C.11.1 Instructions for Roads on Zero to 2% Grade*

For road projects whose base materials extend below the surrounding grade, the below grade volume of base materials may be modeled in WWHM as a Gravel trench/bed with a set infiltration rate. The pervious pavement area is entered as a basin with an equivalent amount of impervious area that is routed to the gravel trench/bed. If an underdrain is installed at the bottom of the base materials, the pavement is modeled as impervious surface without a gravel trench.

First, place a “basin” icon in the “Schematic” grid. Enter the appropriate pre-developed and post-developed descriptions of your project site (or threshold discharge area of the project site). Assume that your pervious pavement surfaces are impervious surfaces. By placing a Gravel trench/bed icon below the basin icon in the Schematic grid, we are routing the runoff from the road and any other tributary area into the below grade volume that is represented by the Gravel trench/bed.

Enter the dimensions of the Gravel trench/bed: the length of the base materials that are below grade (parallel to the road); the width of the below grade material volume; and the depth. The available storage is the void volume in the gravel base layer below the pervious pavement. Enter the void ratio for the gravel base in the Layer 1 field. For example, for a project with a gravel base of 32% porosity, enter 0.32 for the Layer 1 porosity. If the below grade base course has perforated drainage pipes elevated above the bottom of the base course, but below the elevation of the surrounding ground surface, the “Layer 1 Thickness” is the distance from the invert of the lowest pipe to the bottom of the base course.

Also in WWHM3, the Gravel trench/bed facilities must have an overflow riser to model overflows that occur should the available storage get exceeded. So for the “Riser Height”, enter a value slightly smaller than the effective depth of the base materials (say 0.1 ft below the Effective Total Depth); and for the “Riser Diameter” enter a large value (say 10,000 inches) to ensure that there is ample capacity should overflows from the trench occur.

For all infiltration facilities, WWHM3 has a button that asks, “Use Wetted Surface Area?” The answer should remain “NO.”

Using one of the procedures explained in Book 1, Chapter 4, estimate the initial measured (a.k.a., short-term) infiltration rate of the native soils beneath the base materials. Enter that into the “measured infiltration rate” field. For the Infiltration Reduction Factor, enter 0.5.

Run the model to produce the overflow runoff file from the gravel trench. Compare the flow duration graph of that runoff file to the target pre-developed runoff file for compliance with the flow duration standard. If the standard is not achieved a downstream retention or detention facility must be sized (using the WWHM standard procedures) and located in the field. Design the road base materials to direct any water that does not infiltrate into a conveyance system that leads to the retention or detention facility.

#### *C.11.2 Instructions for Roads on Grades above 2%*

Road base material volumes that are below the surrounding grade and that are on a slope can be modeled as a gravel trench with an infiltration rate and a nominal depth. Represent the below



grade volume as the gravel trench. Grab the gravel trench icon and place it below the “basin” icon so that the computer model routes all of the runoff into the gravel trench.

The dimensions of the gravel trench are: the length (parallel to and beneath the road) of the base materials that are below grade; the width of the below grade base materials; and an Effective Total Depth of 1 inch. In WWHM3, all infiltrating facilities must have an overflow riser to model overflows that occur should the available storage get exceeded. So, enter 0.04 ft (½ inch) for the “Riser Height” and a large Riser Diameter (say 1000 inches) to ensure that there is no head build up.

*Note:* If a drainage pipe is embedded and elevated in the below grade base materials, the pipe should only have perforations on the lower half (below the spring line) or near the invert. Pipe volume and trench volume above the pipe invert cannot be assumed as available storage space. If a drainage pipe is placed at the bottom of the base material, the pavement is modeled as an impervious surface without any gravel trench.

Estimate the infiltration rate of the native soils beneath the base materials. See the previous section (Instructions for Roads on Zero to 2% Grade) for estimating options and for how to enter infiltration rates and infiltration reduction factors for the gravel trench. In the “Material Layers” field, enter ½ inch for Layer 1 Thickness and its appropriate porosity. For all infiltration facilities, WWHM3 has a button that asks, “Use Wetted Surface Area?” The answer should remain “NO.”

Run the model to produce the effluent runoff file from the gravel trench (base materials). Compare the flow duration graph of that runoff file to the target pre-developed runoff file for compliance with the flow duration standard. If the standard is not achieved a downstream retention or detention facility must be sized (using the WWHM standard procedures) and located in the field. The road base materials should be designed to direct any water that does not infiltrate into a conveyance system that leads to the retention or detention facility.

### *C.11.3 Instructions for Roads on a Slope with Internal Dams within the Base Materials that are Below Grade*

In this option, a series of infiltration basins is created by placing relatively impermeable barriers across the below grade base materials at intervals downslope. The barriers inhibit the free flow of water down the grade of the base materials. The barriers must not extend to the elevation of the surrounding ground. Provide a space sufficient to pass water from upgradient to lower gradient basins without causing flows to surface out the sides of the base materials that are above grade.

Each stretch of trench (cell) that is separated by barriers can be modeled as a gravel trench. This is done by placing the “Gravel trench/bed” icons in series in WWHM. For each cell, determine the average depth of water within the cell (Average Cell Depth) at which the barrier at the lower end will be overtopped.

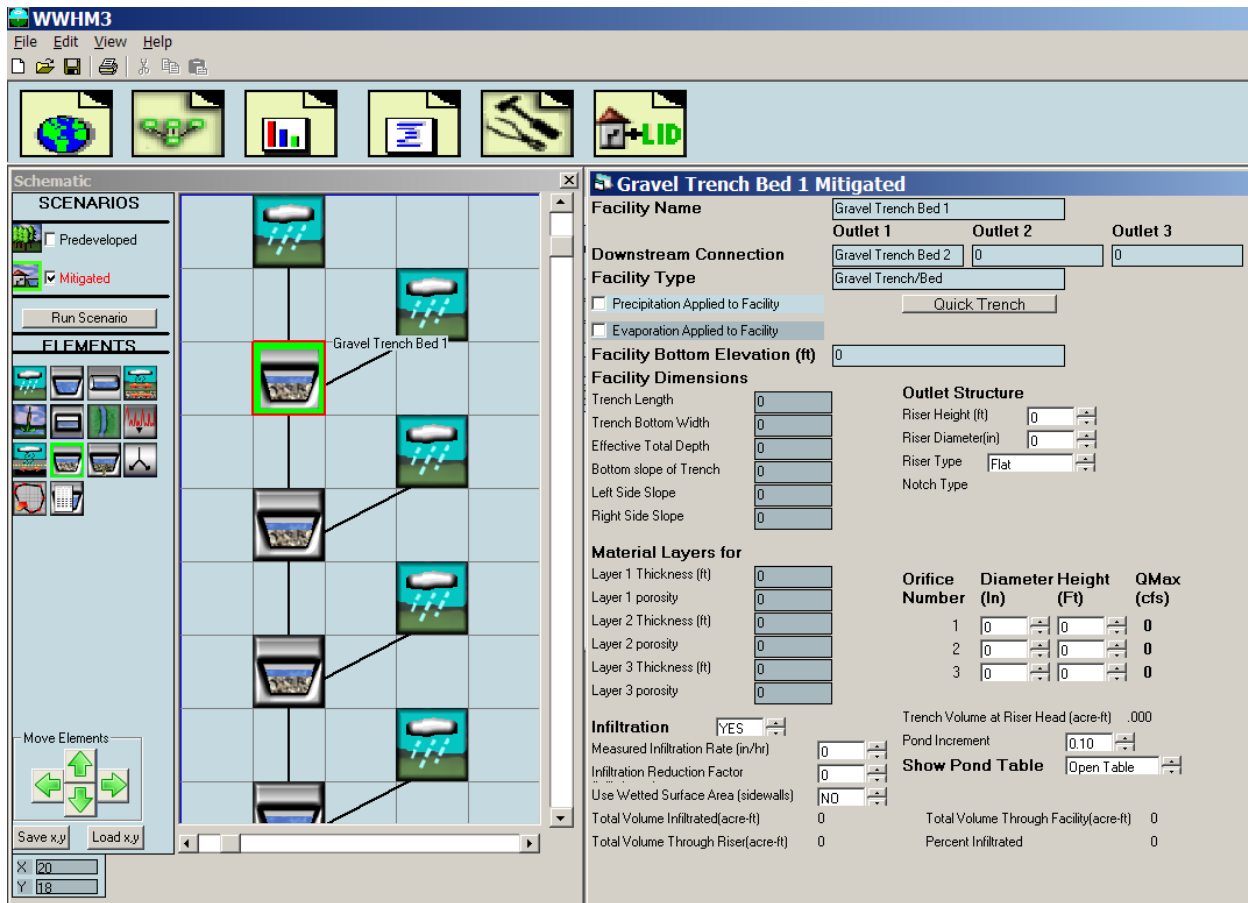
Specify the dimensions of each cell of the below-grade base materials using the “Gravel trench/bed” dimension fields for: the “Trench Length” (length of the cell parallel to the road); the “Trench Bottom Width”(width of the bottom of the base material); and the Effective Total Depth (the Average Cell Depth as determined above).

Also in WWHM3, all infiltrating facilities must have an overflow riser to model overflows that occur should the available storage get exceeded. For each trench cell, the available storage is the

void space within the Average Cell Depth. WWHM calculates the storage/void volume of the trench cell using the porosity values entered in the “Layer porosity” fields. The value for the “*Riser Height*” should be slightly below the “Effective Total Depth” (say by about 1/8” to 1/4”). For the *Riser diameter*, enter a large number (say 10,000 inches) to ensure that there is ample capacity should overflows from the below-grade trench occur.

Each cell should have its own tributary drainage area that includes the road above it, any project site pervious areas whose runoff drains onto and through the road, and any off-site areas. Each drainage area is represented with a “basin” icon.

Below is the computer graphic representation of a series of Gravel trench/beds and the Basins that flow into them.



It is possible to represent a series of cells as one infiltration basin (using a single gravel trench icon) if the cells all have similar length and width dimensions, slope, and Average Cell Depth. A single “basin” icon is also used to represent all of the drainage area into the series of cells.

On the Gravel Trench screen under “Infiltration”, there is a field that asks the following “Use Wetted Surface Area?” By default, it is set to “NO”. It should stay “NO” if the below-grade base material trench has sidewalls steeper than 2 horizontal to 1 vertical.

Using the procedures explained above for roads on zero grade, estimate the infiltration rate of the native soils beneath the trench. Also as explained above, enter the appropriate values into the “Measured Infiltration Rate” and “Infiltration Reduction Factor” boxes.

Run the model to produce the effluent runoff file from the below grade trench of base materials. Compare the flow duration graph of that runoff file to the target pre-developed runoff file for compliance with the flow duration standard. If the standard is not achieved size a downstream retention or detention facility (using the WWHM standard procedures) and locate it in the field. Design the road base materials to direct any water that does not infiltrate into a conveyance system that leads to the retention or detention facility.

## **Part 2: Summary of WWHM 2012 Representation of LID BMPs**

Note: BMP numbering given in this appendix corresponds to numbers in this manual. In some cases, the numbering differs from those given in the SMMWW.

### **Downspout Dispersion – BMP T5.10C**

Where [BMP T5.10C](#) – Downspout Dispersion - is used to disperse runoff into an undisturbed native landscape area or an area that meets [BMP T5.13](#) – Soil Quality and Depth, and the vegetated flow path is at least 50 feet, the connected roof area should be modeled as a lateral flow impervious area. Do this in WWHM on the Mitigated Scenario screen by connecting the dispersed impervious area to the lawn/landscape lateral flow soil basin element representing the area that will be used for dispersion.

Ecology may develop guidance for representing multiple downspout dispersions in a project site. If such guidance is not forthcoming, in situations where multiple downspout dispersions will occur, Clark County allows the roof area to be modeled as a landscaped area (where the 50-foot flowpath requirement is met) or as 50% landscape/50% lawn (where a gravel trench is used to disperse into a vegetated area with a 25 to 50 foot flowpath) so that the project schematic in WWHM becomes manageable.

### **Concentrated Flow Dispersion – BMP T5.11**

Where [BMP T5.11](#) - Concentrated Flow Dispersion - is used to disperse impervious area runoff into an undisturbed native landscape area or an area that meets [BMP T5.13](#) – Soil Quality and Depth, and the vegetated flow path is at least 50 feet, the impervious area should be modeled as a lateral flow impervious area. Do this in WWHM on the Mitigated Scenario screen by connecting the dispersed impervious area to the lawn/landscape lateral flow soil basin element representing the area that will be used for dispersion.

Ecology may develop guidance for representing multiple concentrated flow dispersions in a project site. If such guidance is not forthcoming, in situations where multiple concentrated flow dispersions will occur, Ecology may allow the impervious area to be modeled as a landscaped area so that the project schematic in WWHM becomes manageable.

### **Sheet Flow Dispersion – BMP T5.12**

Where [BMP T5.12](#) – Sheet Flow Dispersion - is used to disperse impervious area runoff into an undisturbed native landscape area or an area that meets [BMP T5.13](#) – Soil Quality and Depth, the impervious area should be modeled as a lateral flow impervious area. Do this in WWHM on the Mitigated Scenario screen by connecting the dispersed impervious area to the lawn/landscape lateral flow soil basin element representing the area that will be used for dispersion.

Ecology may develop guidance for representing multiple sheet flow dispersions in a project site. If such guidance is not forthcoming, in situations where multiple sheet flow dispersions will occur, Ecology may allow the impervious area to be modeled as a landscaped area so that the project schematic in WWHM becomes manageable.

### **Post-Construction Soil Quality and Depth – [BMP T5.13](#)**

Enter area as pasture.

### **Bioretention – BMP T5.14B**

Use new bioretention element for each type: cell, swale, or planter box.

The equations used by the elements are intended to simulate the wetting and drying of soil as well as how the soils function once they are saturated. This group of LID elements uses the modified Green Ampt equation to compute the surface infiltration into the amended soil. The water then moves through the top amended soil layer at the computed rate, determined by Darcy's and Van Genuchten's equations. As the soil approaches field capacity (i.e., gravity head is greater than matric head), the model determines when water will begin to infiltrate into the second soil layer (lower layer). This occurs when the matric head is less than the gravity head in the first layer (top layer). The second layer is intended to prevent loss of the amended soil layer. As the second layer approaches field capacity, the water begins to move into the third layer – the gravel underlayer. For each layer, the user inputs the depth of the layer and the type of soil.

For the Ecology-recommended soil specifications for each layer in the design criteria for bioretention, the model will automatically assign pre-determined appropriate values for parameters that determine water movement through that soil. These include: wilting point, minimum hydraulic conductivity, maximum saturated hydraulic conductivity, and Van Genuchten number.

If a user opts to use soils that deviate from the recommended specifications, the default parameter values do not apply. The user will have to use the Gravel Trench element to represent the bioretention facility and follow the procedures identified for WWHM3 in Part 1 of this appendix.

For Bioretention with underlying perforated drain pipes that discharge to the surface, the only volume available for storage (and modeled as storage as explained herein) is the void space within the aggregate bedding layer below the invert of the drain pipe. Use 40% void space for the Type 26 mineral aggregate specified in [BMP T5.14B](#) in Book 2.

Using the procedures explained in Book 1, Section ~~2.2.1.3~~ and the test methods described in Book 1, Section ~~4.3.1.3~~[2.3.1.4](#), estimate the initial measured (a.k.a. short-term) infiltration rate of the native soils beneath the bioretention soil and any base materials. Because these soils are protected from fouling, not correction factor will be applied.

### **Permeable Pavements – [BMP T5.15](#)**

Use new porous pavement element.

User specifies pavement thickness & porosity, aggregate base material thickness & porosity, maximum allowed ponding depth & infiltration rate into native soil. For grades greater than 2%, see additional guidance.

### **Vegetated Roofs – [BMP T5.17](#)**

Use new green roof element

User specifies media thickness, vegetation type, roof slope, and length of drainage.

### **Impervious Reverse Slope Sidewalks – [BMP T5.18](#)**

Use the lateral flow elements to send the impervious area runoff onto the lawn/landscape area that will be used for dispersion.

Ecology may develop guidance for representing multiple impervious reverse slope sidewalks in a project site. If such guidance is not forthcoming, in situations where multiple impervious reverse slope sidewalks will occur, Ecology may allow the impervious area to be modeled as a landscaped area so that the project schematic in WWHM becomes manageable.

### **Minimal Excavation Foundations – BMP T5.19**

- Where residential roof runoff is dispersed on the up gradient side of a structure in accordance with the design criteria and guidelines in BMP T5.10BC, the tributary roof area may be modeled as pasture on the native soil.
- In “step forming,” the building area is terraced in cuts of limited depth. This results in a series of level plateaus on which to erect the form boards. Where “step forming” is used on a slope, the square footage of roof that can be modeled as pasture must be reduced to account for lost soils. The following equation (suggested by Rick Gagliano of Pin Foundations, Inc.) can be used to reduce the roof area that can be modeled as pasture.

$$A_1 - \frac{dC(.5)}{dP} \times A_1 = A_2$$

$A_1$  = roof area draining to up gradient side of structure

$dC$  = depth of cuts into the soil profile

$dP$  = permeable depth of soil ( The A horizon plus an additional few inches of the B horizon where roots permeate into ample pore space of soil).

$A_2$  = roof area that can be modeled as pasture on the native soil. The rest of the roof is modeled as impervious surface unless it is dispersed in accordance with the next bullet.

- If roof runoff is dispersed down gradient of the structure in accordance with the design criteria and guidelines in BMP T5.10C, AND there is at least 50 feet of vegetated flow path through native material or lawn/landscape area that meets the guidelines in BMP T5.13, the tributary roof areas should be modeled as a lateral flow impervious area. This is done in WWHM on the Mitigated Scenario screen by connecting the dispersed impervious area to the lawn/landscape lateral flow soil basin element representing the area that will be used for dispersion.

Ecology may develop guidance for representing multiple downspout dispersions in a project site. If such guidance is not forthcoming, in situations where multiple downspout (down gradient) dispersions will occur, Ecology may allow the roof area to be modeled as a landscaped area so that the project schematic in WWHM becomes manageable.

### **Full dispersion – BMP T5.30**

If BMP design criteria in Book 2 are followed, the area draining to the BMP is not entered into the runoff model.

### **Full downspout infiltration – BMP T5.10A and BMP T5.10B**

If BMP design criteria in Book 2 are followed, the area draining to the BMP is not entered into the runoff model.

**Rainwater Harvesting – BMP T5.20**

If BMP design criteria in Book 2 are followed, the area draining to the BMP is not entered into the runoff model.

**Newly planted trees – BMP T5.16**

If BMP design criteria in Book 2 are followed, the total impervious/hard surface areas entered into the runoff model may be reduced by an amount indicated in the criteria for the BMP in Book 2.

**Retained trees – BMP T5.16**

If BMP design criteria in Book 2 are followed, the total impervious/hard surface areas entered into the runoff model may be reduced by an amount indicated in the criteria for the BMP in Book 2.

**Perforated Stub-out Connection – BMP T5.10D**

Any flow reduction is variable and unpredictable. No computer modeling techniques are allowed that would predict any reduction in flow rates and volumes from the connected area.

This page left blank intentionally



## Appendix 2-D

### Approaches to Infiltration Facility Design

This page left blank intentionally

## Approaches to Infiltration Facility Design

Three methods for obtaining a design coefficient of permeability (or infiltration rate), and for designing infiltration facilities are allowed: the ASCE approach, the Simplified Approach and the Detailed Approach. These are described below.

1. The ASCE approach is to be used when using the Modified Single-Ring Falling Head Test. See Appendix 1-D [C](#) in Book 1.
2. The Simplified Approach can be used when field testing was performed using either PIT test method or the Soil Grain Size Analysis Method. This method was derived from high groundwater and shallow pond sites in western Washington, and in general will produce conservative designs. The Simplified Approach can be used when determining the trial geometry of the infiltration facility, or for small facilities serving short plats or commercial developments with less than 1 acre of contributing area.
3. The Detailed Approach can be used when field testing was performed using either PIT test method or the Soil Grain Size Analysis Method. Designs of infiltration facilities for projects larger than one acre that used either PIT test or the Soil Grain Size method for obtaining the field-measured coefficient of permeability must use the Detailed Approach.

### Simplified Approach

The simplified approach is applicable to drywells, ponds, and trenches and includes five steps.

#### Step 1: Select a Location and Determine Site Suitability

Select a site and conduct a preliminary surface and Site Characterization Study per [Book 1](#), Section 4.4 [3.1.2](#).

Review the following site suitability criteria. When a site investigation reveals that any of the following criteria cannot be met, consider appropriate measures such as relocation or resizing so that the infiltration facility will not pose a threat to safety, health, and the environment and meet the requirements in this section.

- Setback Criteria as described in [Book 1](#), Section 4.4, Table 4.1.
- Critical Aquifer Recharge Areas (CARA). Review [Book 1](#), Section 4.2.2 [3.1.1](#) and CCC 40.410 for regulation regarding installation of infiltration facilities within CARA sites.
- High Vehicle Traffic Areas. An infiltration BMP can be used in areas of industrial activity and the high vehicle traffic areas described below. For such applications, provide sufficient pollutant removal (including oil removal) upstream of the infiltration facility to ensure that groundwater quality standards will not be violated and that the infiltration facility will not be adversely affected.

High Vehicle Traffic Areas are:

- Commercial or industrial sites subject to an expected average daily traffic count (ADT)  $\geq 100$  vehicles/1,000 ft<sup>2</sup> gross building area (trip generation).
- Road intersections with an ADT of  $\geq 25,000$  on the main roadway and  $\geq 15,000$  on any intersecting roadway.

## Step 2: Estimate Volume of Stormwater, V<sub>design</sub>

Estimate the volume of stormwater by using a continuous hydrograph and an approved continuous flow model for the calculations. The runoff file developed for the project site serves as input to the infiltration facility.

- For infiltration facilities sized to meet treatment requirements, the basin must successfully infiltrate 91% of the influent runoff file. The remaining 9% of the influent file can bypass the infiltration facility.
- For infiltration basins sized to meet the flow control standard, the basin must infiltrate either all of the influent file, or a sufficient amount of the influent file such that any overflow/bypass meets the flow duration standard. In addition, the overflow/bypass must meet the LID Performance Standard, if applicable according to thresholds in Minimum Requirement #5, Section 1.5.5.

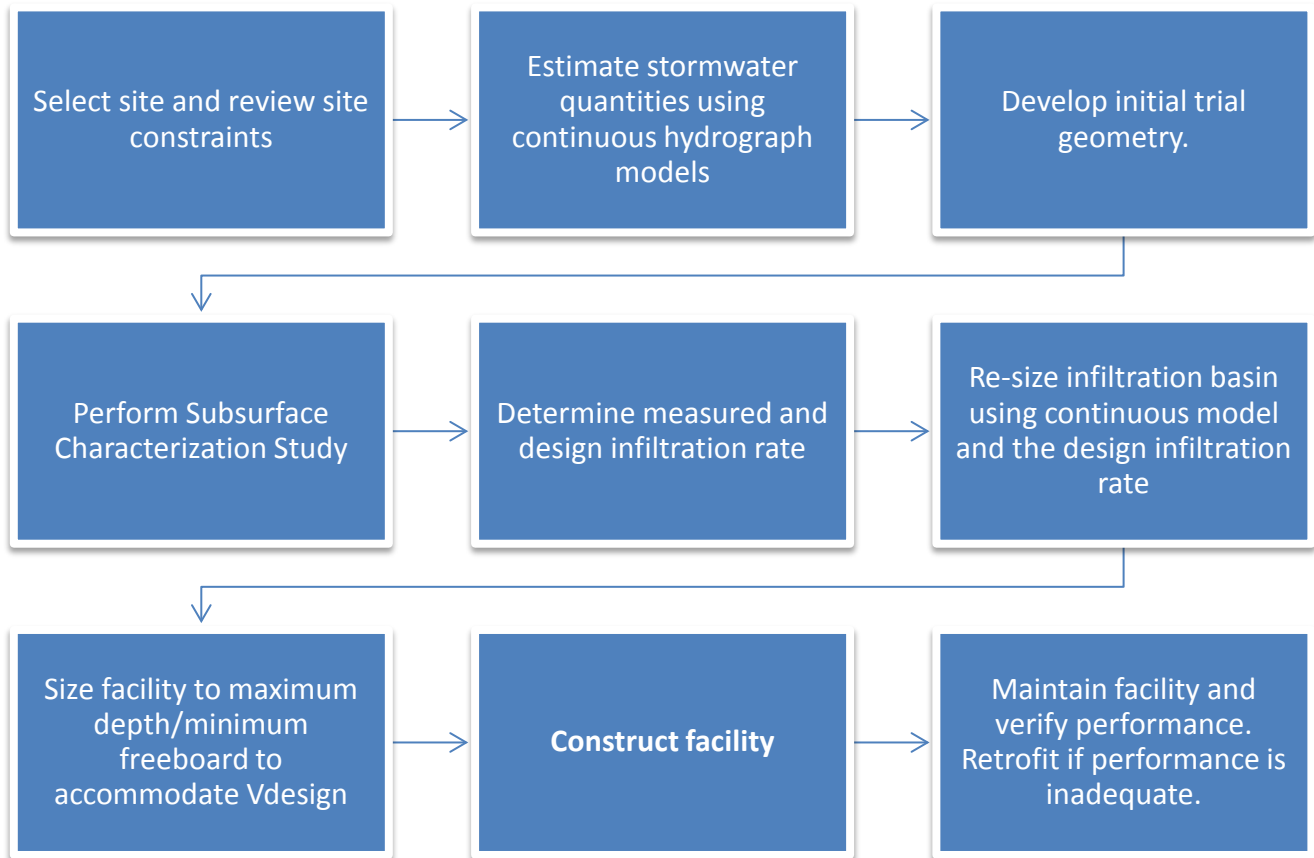
## Step 3: Develop Trial Infiltration Facility Geometry

To develop the trial facility geometry assume an infiltration rate based on previously available data, or a default infiltration rate of 0.5 inches/hour. Use this trial facility geometry to help locate the facility and for planning purposes in developing the geotechnical subsurface investigation plan.

## Step 4: Determine the Design Infiltration Rate

Estimate the design (long-term) infiltration rate as follows:

- Use an allowed method listed in Section 4.5.23.1.3 to field-measure the coefficient of permeability.
- Adjust this rate using the appropriate correction factors, as explained in Section 4.5.43.1.3.



### Infiltration Design using the Simplified Approach

#### Step 5: Size the Facility per Chapter 4

See Section 4.8 for infiltration facility design criteria, including sizing, for both flow control and treatment infiltration facility types.

### Detailed Approach to Infiltration Facility Design

This detailed approach was obtained from Massmann (2003). The detailed approach includes the first five steps of the Simplified Approach and the following steps:

#### Steps: 1 – 5

Steps 1 through 5 are the same as indicated for the Simplified Approach, above.

#### Step 6: Calculate the Hydraulic Gradient

Calculate the steady state hydraulic gradient as follows (Massman et al, 2003):

### Equation 1

$$gradient = i \approx \frac{D_{wt} + D_{pond}}{138.62 (K^{0.1})} CF_{size}$$

Where:

$D_{wt}$  is the depth from the base of the infiltration facility to the water table in feet,

$D_{pond}$  is one-quarter of the maximum depth of water in the facility in feet,

$K$  is the design (long-term) coefficient of permeability in feet/day,  $CF_{size}$ , is the correction for pond size as found in the following paragraph and Equation 2.

The correction factor was developed for ponds with bottom areas between 0.6 and 6 acres in size. For ponds smaller than this, the correction factor is equal to 1.0. For large ponds (ponds with an area greater than or equal to 6 acres), the correction factor is 0.2.

### Equation 2

$$CF_{size} = 0.73(A_{pond})^{-0.76}$$

Where  $A_{pond}$  is the area of pond bottom in acres.

This equation generally will result in a calculated gradient of less than 1.0 for moderate to shallow groundwater depths (or to a low permeability layer) below the facility, and conservatively accounts for the development of a groundwater mound. A more detailed groundwater mounding analysis using a program such as MODFLOW will usually result in a gradient that is equal to or greater than the gradient calculated using Equation 1. If the calculated gradient is greater than 1.0, the water table is considered to be deep, and a maximum gradient of 1.0 must be used.

Typically, a depth to groundwater of 100 feet or more is required to obtain a gradient of 1.0 or more using this equation. Since the gradient is a function of depth of water in the facility, the gradient will vary as the pond fills during the season. The gradient could be calculated as part of the stage-discharge calculation used in the continuous runoff models. As of the date of this manual, neither the WWHM or MGSFlood have that capability. However, updates to those models may soon incorporate the capability. Until that time, use a steady-state hydraulic gradient that corresponds with a ponded depth of 1/4 of the maximum ponded depth – as measured from the basin floor to the overflow.

**Step 7: Calculate the Preliminary Design Infiltration Rate using Darcy’s Law****Equation 3**

$$f = K \left( \frac{dh}{dz} \right) = Ki$$

Where:

$f$  is the specific discharge or infiltration rate of water through a unit cross-section of the infiltration facility (L/t),

$K$  is the design coefficient of permeability (L/t),

$dh/dz$  is the hydraulic gradient (L/L), and

“ $i$ ” is the gradient (See Equation 1).

**Step 8: Adjust the Preliminary Design Infiltration Rate or Infiltration Stage-Discharge Relationship Obtained in Step 7**

Adjustments of the initial infiltration rate estimate should have been made in Step 5.

This step adjusts the preliminary design infiltration rate for the effect of pond aspect ratio by multiplying the infiltration rate determined in Step 7 by the aspect ratio correction factor  $CF_{aspect}$  as shown in the following equation:

**Equation 4**

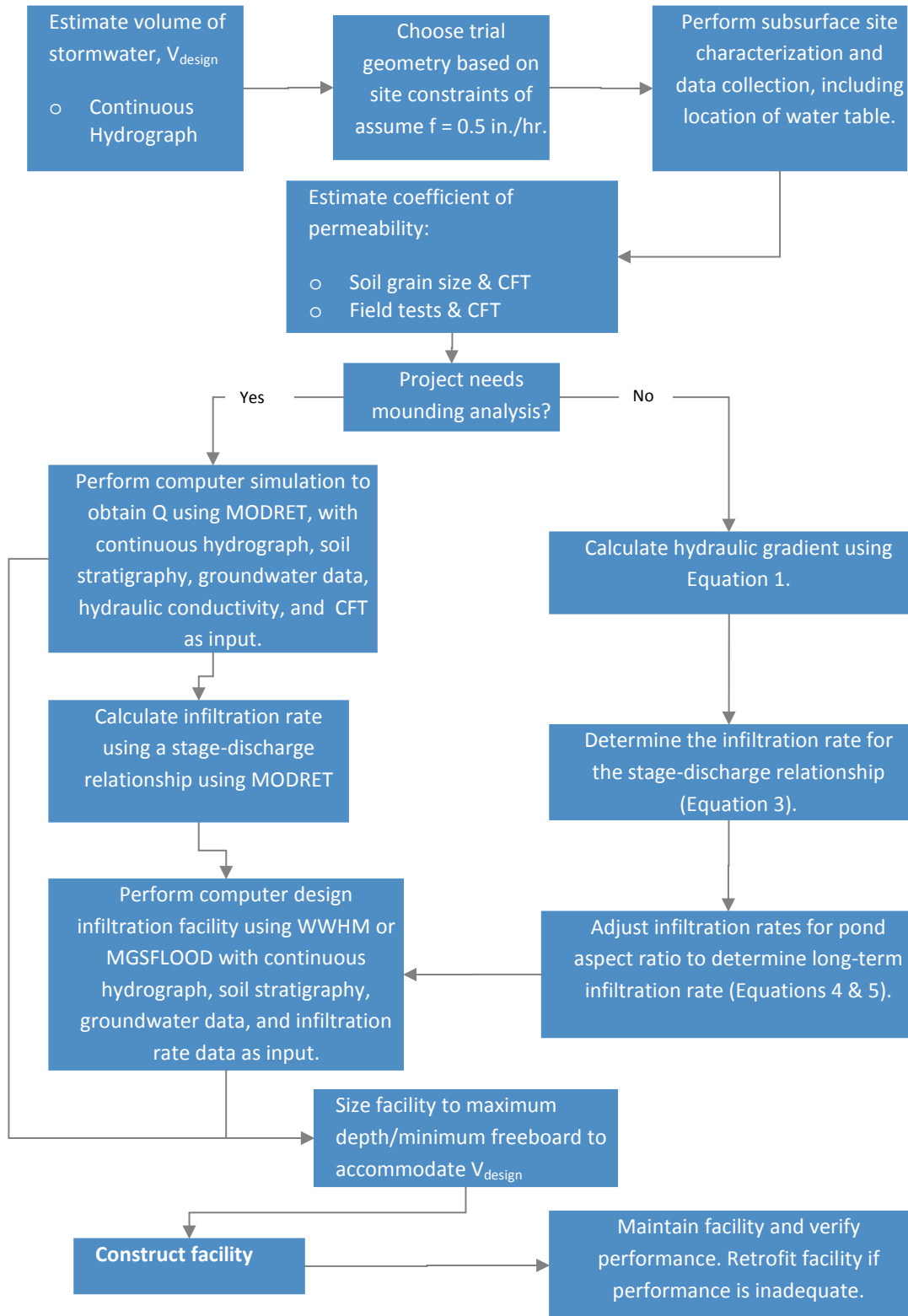
$$CF_{aspect} = 0.02A_r + 0.98$$

Where,  $A_r$  is the aspect ratio for the pond (length/width of the bottom area). In no case shall  $CF_{aspect}$  be greater than 1.4.

The final design (long-term) infiltration rate will therefore be as follows:

**Equation 5**

$$f = (K)(i)(CF_{aspect})$$



### Infiltration Design using the Detailed Approach



## Step 9: Size the Facility per Chapter 4

See Section 4.8 for infiltration facility design criteria, including sizing, for both flow control and treatment infiltration facility types.

## Step 10: Groundwater Mounding Analysis

Groundwater mounding occurs under infiltration areas where the infiltration of stormwater causes the water under the infiltration facility to “mound up” before dispersing into the ground. This can occur where groundwater or a low permeability soil layer is near the surface. Groundwater mounding can reduce infiltration rates and cause the failure of infiltration facilities.

A groundwater mounding analysis shall be conducted at all sites where the following occurs:

- The depth to either the seasonal groundwater table or a low permeability soil stratum is less than 5 feet from the infiltration facility bottom; or
- The depth to the seasonal groundwater table or low permeability stratum is less than 15 feet, and the effective impervious area contributing runoff to the infiltration facility is greater than 1 acre.

Groundwater modeling (mounding analysis) of the proposed infiltration facility shall be done using the design infiltration rate and the estimated maximum groundwater elevation determined for the proposed facility location.

The design infiltration rate determined above can be used as input to an approved continuous simulation hydrologic model to do an initial sizing. Then complete the groundwater modeling (mounding analysis) of the proposed infiltration facility. Use MODRET or an equivalent model.

Export the full output hydrograph of the developed condition and use it as input to MODRET. Note that an iterative process may be required beginning with an estimated design rate, WWHM (or MGSFlood) sizing, then groundwater model testing.

## Infiltration References

Massmann, Joel, A Design Manual for Sizing Infiltration Ponds, October 2003.

Massmann, Joel and Carolyn Butchart. Infiltration Characteristics, Performance, and Design of Storm Water Facilities, U. of Washington, March 2000.

## Appendix 2-E

### Bioretention Soil Mix Hydraulic Conductivity



## Recommended Modifications to ASTM D 2434 When Measuring Hydraulic Conductivity for Bioretention Soil Mixes

Developed by the City of Seattle in cooperation with local soils laboratories.

Proctor method ASTM D1557 Method C (6-inch mold) shall be used to determine maximum dry density values for compaction of bioretention soil sample. Sample preparation for the Proctor test shall be amended in the following ways:

- 1) Maximum grain size within the sample shall be no more than ½ inches in size.
- 2) Snip larger organic particles (if present) into ½ inch long pieces.
- 3) When adding water to the sample during the Proctor test, allow the sample to pre-soak for at least 48 hours to allow the organics to fully saturate before compacting the sample. This pre-soak ensures the organics have been fully saturated at the time of the test.

ASTM D2434 shall be used and amended in the following ways:

- 1) Apparatus:
  - a. 6-inch mold size shall be used for the test.
  - b. If using porous stone disks for the testing, the permeability of the stone disk shall be measured before and after the soil tests to ensure clogging or decreased permeability has not occurred during testing.
  - c. Use the confined testing method, with 5- to 10-pound force spring
  - d. Use de-aired water.
- 2) Sample:
  - a. Maximum grain size within the sample shall not be more than ½ inch in size.
  - b. Snip larger organic particles (if present) into ½-inch long pieces.
  - c. Pre-soak the sample for at least 48 hours prior to loading it into the mold. During the pre-soak, the moisture content shall be higher than optimum moisture but less than full saturation (i.e., there shall be no free water). This pre-soak ensures the organics have been fully saturated at the time of the test.
- 3) Preparation of Sample:
  - a. Place soil in cylinder via a scoop.
  - b. Place soil in 1-inch lifts and compact using a 2-inch-diameter round tamper. Pre-weigh how much soil is necessary to fill 1-inch lift at 85% of maximum dry density, then tamp to 1-inch thickness. Once mold is full, verify that density is at 85% of maximum dry density (+ or – 0.5%). Apply vacuum (20 inches Hg) for 15 minutes before inundation.
  - c. Inundate sample slowly under a vacuum of 20 inches Hg over a period of 60 to 75 minutes.

- d. Slowly remove vacuum ( $> 15$  seconds).
  - e. Sample shall be soaked in the mold for 24 to 72 hours before starting test.
- 4) Procedure:
- a. The permeability test shall be conducted over a range of hydraulic gradients between 0.1 and 2.
  - b. Steady state flow rates shall be documented for four consecutive measurements before increasing the head.
  - c. The permeability test shall be completed within one day (one-day test duration).

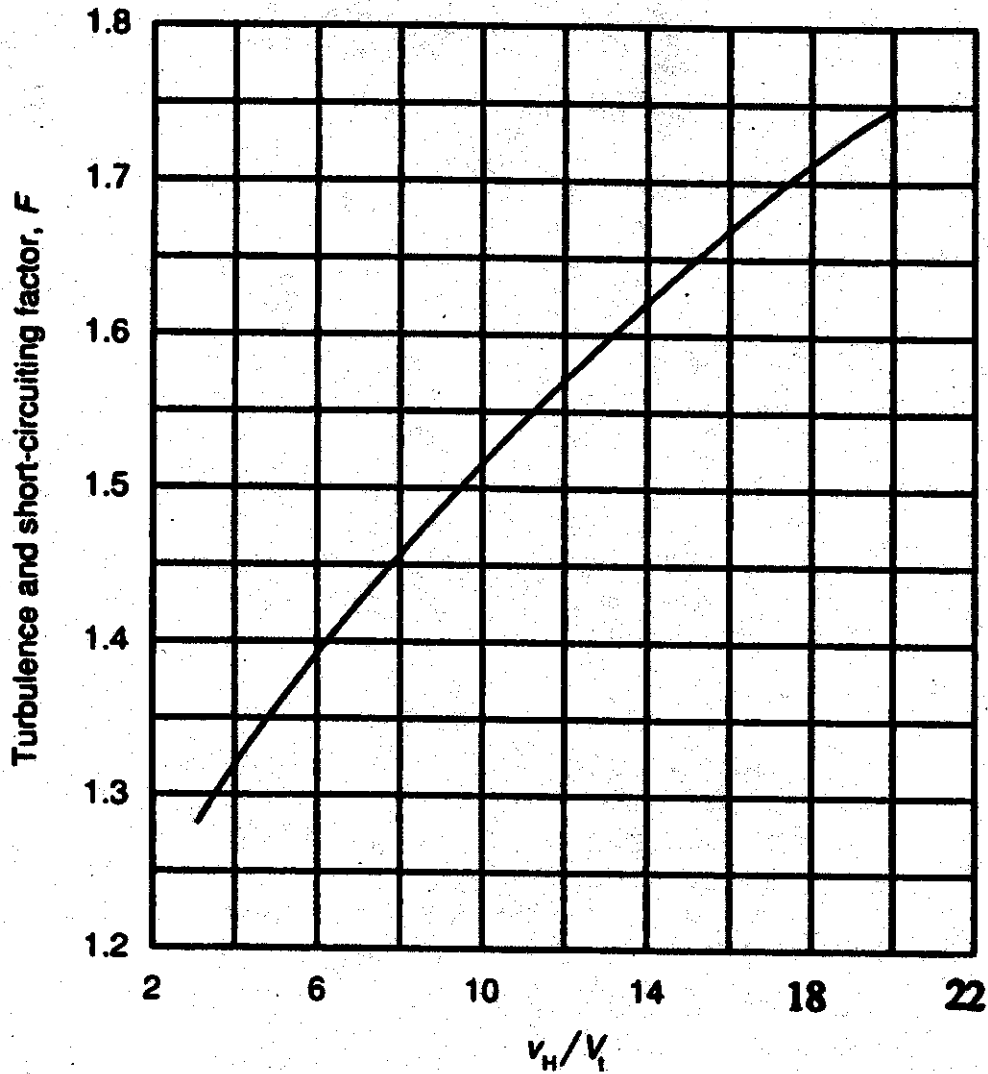
# Appendix 2-F

## Turbulence and Short-Circuiting Factor





## Turbulence and Short-Circuiting Factor



$v_H/V_i$	Turbulence Factor ( $F_t$ )	$F = 1.2(F_t)$
20	1.45	1.74
15	1.37	1.64
10	1.27	1.52
6	1.14	1.37
3	1.07	1.28

Recommended Values of  $F$  for Various Values of  $v_H/V_t$



# Appendix 2-G

## Geotextile Specifications



## Geotextile Specifications

<b>Table G-1</b> <b>Geotextile Properties for Underground Drainage</b> Geotextile Property Requirements <sup>1</sup>			
		<b>Low Survivability</b>	<b>Moderate Survivability</b>
<b>Geotextile Property</b>	<b>Test Method</b>	<b>Woven/Nonwoven</b>	<b>Woven/Nonwoven</b>
Grab Tensile Strength, in machine and x-machine direction	ASTM D4632	180 lbs/115 lbs min.	250 lbs/160 lbs min.
Grab Failure Strain, in machine and x-machine direction	ASTM D4632	<50%/>=50%	<50%/>=50%
Seam Breaking Strength (if seams are present) with seam located in the center of 8-inch-long specimen oriented parallel to grip faces	ASTM D4632	160 lbs/100 lbs min.	220 lbs/140 lbs min.
Puncture Resistance	ASTM D6241	370 lbs/220 lbs min.	495 lbs/310 lbs min.
Tear Strength, in machine and x-machine direction	ASTM D4533	67 lbs/40 lbs min.	80 lbs/50 lbs min.
Ultraviolet (UV) Radiation stability	ASTM D4355	50% strength retained min., after 500 hrs. in a xenon arc device	50% strength retained min., after 500 hrs. in a xenon arc device

<sup>1</sup> All geotextile properties are minimum average roll values (i.e., the test result for any sampled roll in a lot shall meet or exceed the values shown in the table).

<b>Table G-2 Geotextile for Underground Drainage Filtration Properties</b>				
<b>Geotextile Property Requirements<sup>1</sup></b>				
<b>Geotextile Property</b>	<b>Test Method</b>	<b>Class A</b>	<b>Class B</b>	<b>Class C</b>
AOS <sup>2</sup>	ASTM D4751	No. 40 max.	No. 60 max.	No. 80 max.
Water Permittivity	ASTM D4491	0.5 sec <sup>-1</sup> min.	0.4 sec <sup>-1</sup> min.	0.3 sec <sup>-1</sup> min.

<sup>1</sup> All geotextile properties are minimum average roll values (i.e., the test result for any sampled roll in a lot shall meet or exceed the values shown in the table).

<sup>2</sup> Apparent Opening Size (measure of diameter of the pores in the geotextile)

<b>Table G-3 Geotextile Strength Properties for Impermeable Liner Protection</b>		
<b>Geotextile Property</b>	<b>Test Method</b>	<b>Geotextile Property Requirements<sup>1</sup></b>
Grab Tensile Strength, min. in machine and x-machine direction	ASTM D4632	250 lbs min.
Grab Failure Strain, in machine and x-machine direction	ASTM D4632	>50%
Seam Breaking Strength (if seams are present)	ASTM D4632 and ASTM D4884 (adapted for grab test)	220 lbs min.
Puncture Resistance	ASTM D4833	125 lbs min.
Tear Strength, min. in machine and x-machine direction	ASTM D4533	90 lbs min.
Ultraviolet (UV) Radiation	ASTM D4355	50% strength stability retained min., after 500 hrs. in weatherometer

<sup>1</sup> All geotextile properties are minimum average roll values (i.e., the test result for any sampled roll in a lot shall meet or exceed the values shown in the table).

## Applications

1. For sand filter drain strip between the sand and the drain rock or gravel layers specify Geotextile Properties for Underground Drainage, moderate survivability, Class A, from C-1 and C-2 in the Geotextile Specifications.
2. For sand filter matting located immediately above the impermeable liner and below the drains, the function of the geotextile is to protect the impermeable liner by acting as a cushion. The specification provided in [Table G-3](#) should be used to specify survivability properties for the liner protection application. Table 2, Class C should be used for filtration properties. Only nonwoven geotextiles are appropriate for the liner protection application.
3. For an infiltration drain specify Geotextile for Underground Drainage, low survivability, Class C, from Tables [G-1](#) and [G-2](#) in the Geotextile Specifications.
4. For a sand bed cover a geotextile fabric is placed exposed on top of the sand layer to trap debris brought in by the storm water and to protect the sand, facilitating easy cleaning of the surface of the sand layer. However, a geotextile is not the best product for this application. A polyethylene or polypropylene geonet would be better. The geonet material should have high UV resistance (90% or more strength retained after 500 hours in the weatherometer, ASTM D4355), and high permittivity (ASTM D4491, 0.8 sec. -1 or more) and percent openarea (CWO-22125, 10% or more). Tensile strength should be on the order of 200 lbs grab (ASTM D4632) or more.

Courtesy of Tony Allen, Geotechnical Engineer-WSDOT

Reference for Tables C-1 and C-2: Section 9-33.2 “Geotextile Properties,” 2012 Standard Specifications for Road, Bridge, and Municipal Construction.