

Clark County Stormwater Manual
Book 4 – Stormwater Facility Operations and Maintenance
~~Adoption Final~~ Review Draft
~~November 24, 2015~~

The *Clark County Stormwater Manual: Book 4 – Stormwater Facility Operations and Maintenance* is adapted from the Clark County *Stormwater Facility Maintenance Manual*, 2009 and the *Stormwater Management Manual for Western Washington, Volume V*, (Ecology, ~~2014~~ 2019).

Illustrations are courtesy Washington Department of Ecology or redrawn from Washington Department of Ecology, unless otherwise noted. Illustrations are simplified representations of stormwater facilities; they are not to scale and not for engineering design or construction.

Table of Contents

Introduction	1
Background	1
Purpose	1
Why Maintain Stormwater Facilities?	1
Maintenance Resources and Standards	2
Organization of this Book	2
Emerging Treatment Technologies	3
Mosquito Control.....	3
References	3
Stormwater Treatment, Flow Control, and Conveyance Facility Components	5
Field Inlet	6
Catch Basin	9
Manhole.....	12
Catch Basin Insert.....	15
Control Structure/Flow Restrictor.....	17
Debris Barrier & Access Barrier (e.g. Trash Rack).....	20
Energy Dissipater / Outfall Protection	22
Stormwater Conveyance Pipe.....	24
Stormwater Facility Discharge Points / Pipe Outlets.....	25
Hydrodynamic Separator System.....	27
Sediment Trap	29
Oil/Water Separator (API Type)	33
Coalescing Plate Oil/Water Separator	36
Prettling Basin (Forebay or pretreatment BMP).....	39
Detention Pond.....	41
Wetpond.....	47
Filter Strip.....	52
Compost-Amended Vegetated Filter Strip (CAVFS)	55
Media Filter Drain (MFD)	57
Basic Biofiltration Swale.....	59
Wet Biofiltration Swale.....	64
Treatment Wetland	67

Closed Detention System (Tank/Vault)	72
Wet Vault.....	75
Modular Detention Systems	78
Media Cartridge Filters	80
<u>Planter Box Media Filters.....</u>	<u>84</u>
Bioretention System	86
Permeable Pavement.....	944
Vegetated Roof.....	100
Sand Filter Open (Above Ground).....	1044
Sand Filter Vault (Below Ground/Enclosed)	1088
Infiltration Trench.....	1122
Infiltration Basin.....	1144
Drywell	1206
Access Road and Easement	1233
Fence, Gate, and/or Water Quality Sign	1255
Vegetation.....	1266

On-site Stormwater Management
13131

Downspout Infiltration	1322
Downspout Dispersion	1355
Sheet Flow and Concentrated Dispersion	1399
Compost-Amended Soil.....	1422
Rain Garden	1444

Table of Tables

Table 1: Stormwater Tract "Low Grow" Seed Mix* for Detention Pond	43
Table 2: Emergent Wetland Plant Species Acceptable for Wetponds	49
Table 3: Plant Mixes for Biofiltration Swale Treatment Area	61
Table 4: Groundcovers and Grasses Suitable for Upper Side Slopes of a Swale	62
Table 5: Acceptable Plants for Wet Biofiltration Swale	65
Table 6: Emergent Wetland Species for Treatment Wetlands	69
Table 7: Plant List for Bioretention System and Rain Garden*.....	88
Table 8: Stormwater Tract "Low Grow" Seed Mix for Infiltration Basin.....	116
Table 9: Plant List for Bioretention System and Rain Garden*.....	145

Introduction

Background

Stormwater facilities include pipes, catch basins, manholes, grassy treatment swales, ditches, drywells, ponds, oil/water separators, and any other structures that collect, convey, control, or treat stormwater drainage. More recently, on-site or low impact development (LID) facilities such as rain gardens and permeable pavement are included in the list of stormwater facilities. Stormwater facilities are found in a variety of locations, including business sites, residential areas, government facilities and roadways. Stormwater facilities on private sites often drain to roadside ditches, county storm sewer pipes, streams, or to groundwater from infiltration facilities.

The federal Clean Water Act, the federal Safe Drinking Water Act, and rules to protect threatened salmon under the federal Endangered Species Act require Clark County to ensure that stormwater facilities in unincorporated Clark County are properly operated and maintained.

Purpose

Stormwater facility owners and operators are required to maintain the stormwater facilities in their care in compliance with the standards of this book and the Clark County codes listed below.

This book is intended to meet all stormwater facility operation and maintenance requirements under Clark County Code (CCC) [Chapter 13.26A](#), Water Quality, and [Chapter 40.386](#), Stormwater and Erosion Control. It applies to County operations, as well as to public or privately owned and operated stormwater facilities in unincorporated areas of Clark County.

Stormwater facilities are often in or near areas that are also fish and wildlife habitat. This book helps make sure that owners perform maintenance in a way that conforms to regulations protecting fish and wildlife.

Why Maintain Stormwater Facilities?

Along with helping to prevent flooding, properly maintained stormwater facilities can help reduce pollution of surface water and groundwater.

Stormwater facility maintenance is necessary to protect streams, lakes, wetlands, and groundwater. Proper maintenance helps ensure that facilities operate as they were designed and that trapped pollutants, such as sediment and oils, are cleaned out so that the facilities do not become pollutant sources.

Maintenance Resources and Standards

This book will help facility owners and operators follow requirements for maintenance. This book describes potential maintenance problems (defects), conditions when maintenance is needed, and minimum performance standards for each type of stormwater facility found in Clark County. If a site was approved for construction under county stormwater requirements adopted in 1994 or later, then the stormwater facilities should have an approved plan for maintenance.

Additional guidance on procedures for LID facilities may be found in the *Western Washington Low Impact Development (LID) Operation and Maintenance (O&M)* (Ecology, 2013) guidance document.

The maintenance standards contained in this book are minimum performance standards. Inspection of a stormwater facility will determine if conditions require a maintenance action. Maintenance standards are not intended to describe a facility's required condition at all times between inspections. Exceeding a condition at any time between inspections and/or maintenance does not automatically constitute a violation of these standards. However, based upon inspection observations, the inspection and maintenance schedules shall be adjusted to minimize the length of time that a facility is in a condition that requires maintenance.

Many defects listed in this Book are not specifically related to facility performance to treat pollutants and control runoff rates. The presence of a defect that does not hinder treatment, flow control, or public safety is not a violation of county code.

Organization of this Book

This book is divided into two sections:

- The Stormwater Treatment, Flow Control and Conveyance Facility Components section contains facility types that are common in subdivisions, commercial property, and roads. These facilities are commonly maintained by County staff, professional landscapers, property management personnel, or Homeowners' Associations.
- The On-site Stormwater Management section contains LID facility types such as rain gardens that are becoming common on residential lots. These facilities are commonly maintained by the residential property owners.

Each facility type contains:

- A brief description of the type of facility, often including an illustration.
- Key operations and maintenance considerations, which are suggested maintenance methods.
- An inspection and maintenance table describing minimum performance standards for maintenance.

Emerging Treatment Technologies

Some stormwater treatment facilities are designed and installed with emerging technologies that are not (or were not) standard at the time of their installation. If not found in this manual, a treatment facility may be an emerging technology approved by Washington Department of Ecology in a General Use Level Designation. Maintenance standards in General Use Level Designation approvals for emerging technologies not found in this manual are adopted by reference and can be found at www.ecy.wa.gov/programs/wq/stormwater/newtech/index.html.

Mosquito Control

Mosquitoes can be annoying and sometimes pose a serious risk to public health. They can transmit diseases such as West Nile Virus and equine encephalitis.

Above-ground stormwater facilities should be designed to allow water to flow through or infiltrate in less than 48 hours. Presence of mosquitos in a stormwater facility may indicate a clogged outlet, compromised infiltration capacity, or other defect that should trigger inspection and may require maintenance.

To combat mosquitoes, Clark County has established a mosquito control program. Information on the Clark County Mosquito Control District can be accessed online at www.clark.wa.gov/public-health/mosquito-control-district.

If mosquitoes are identified during stormwater facility maintenance or inspection and are a concern, a request to the Clark County Mosquito Control District for service or information regarding mosquito control can be made online or at the 24-hour request line, (360) 397-8430.

References

This book draws on other maintenance manuals. Along with documenting current county standards and practices, this book includes maintenance practices from or refers to the following documents:

- Washington Department of Ecology *Stormwater Management Manual for Western Washington* (SMMWW) (December, ~~2014~~2019)
- Washington Department of Ecology *Western Washington Low Impact Development (LID) Operation and Maintenance (O&M)* (July, 2013)

This page intentionally left blank.

Stormwater Treatment, Flow Control, and Conveyance Facility Components

The BMPs in this section are stormwater treatment, flow control, and conveyance facilities (and their components) that commonly serve subdivisions, commercial developments, and roads. BMPs that typically serve individual residential lots are listed in the next section, [On-site Stormwater Management](#).

Field Inlet

A field inlet is a concrete structure fitted with a slotted grate to collect stormwater runoff and route it through underground pipes.

Field inlets typically provide a storage volume (sump) below the outlet pipe to allow sediments and debris to settle out of the stormwater runoff. Some field inlets are fitted with a spill control device (inverted elbow on outlet pipe) intended to contain large quantities of grease or oils.

Facility objects that are typically associated with a field inlet include:

- access road or easement
- control structure/flow restrictor
- biofiltration swale
- detention pond
- infiltration trench

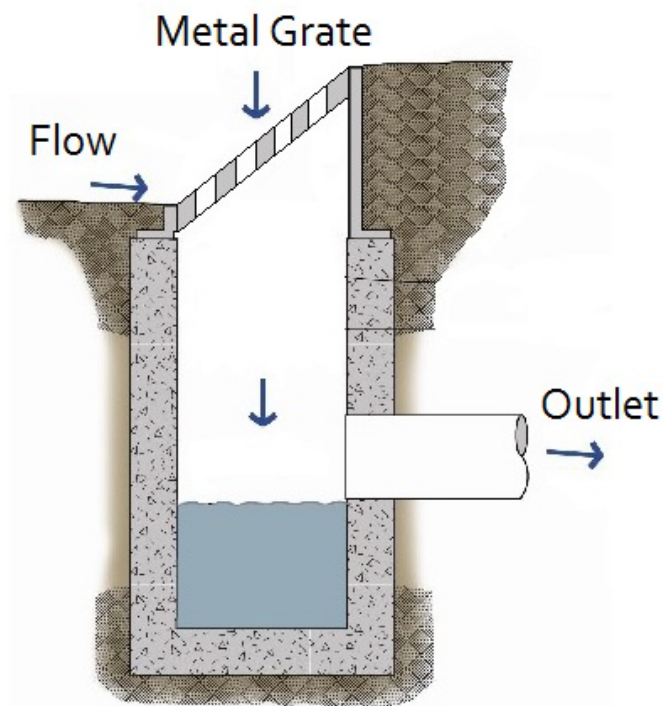

Key Operations and Maintenance Considerations

- The most common tool for cleaning field inlets is a truck with a tank and vacuum hose (Vactor® truck) to remove sediment and debris from the sump.

Stormwater Treatment, Flow Control, and Conveyance Facility Components

- A field inlet may be an enclosed space where harmful chemicals and vapors can accumulate. Therefore, if the inspection and maintenance requires entering a field inlet, it should be conducted by an individual trained and certified to work in hazardous confined spaces.

Field Inlet			
Drainage System Feature	Potential Defect	Conditions When Maintenance Is Needed	Minimum Performance Standard
Note: table spans multiple pages.			
General	Trash and Debris	Trash or debris which is located immediately in front of the catch basin opening or is blocking inletting capacity of the field inlet by more than 10%.	No trash or debris located immediately in front of field inlet or on grate opening.
		Trash or debris (in the field inlet) that exceeds 60 percent of the sump depth as measured from the bottom of basin to invert of the lowest pipe into or out of the basin, but in no case less than a minimum of six inches clearance from the debris surface to the invert of the lowest pipe.	No trash or debris in the field inlet.
		Trash or debris in any inlet or outlet pipe blocking more than 1/3 of its height.	Inlet and outlet pipes free of trash or debris.
		Dead animals or vegetation that could generate odors that could cause complaints or dangerous gases (e.g., methane).	No dead animals or vegetation present within the field inlet.
	Sediment	Sediment (in the basin) that exceeds 60 percent of the sump depth as measured from the bottom of basin to invert of the lowest pipe into or out of the basin, but in no case less than a minimum of 6 inches clearance from the sediment surface to the invert of the lowest pipe.	No sediment in the field inlet.
	Structure Damage to Frame and/or Top Slab	Top slab has holes larger than 2 square inches or cracks wider than 1/4 inch. (Intent is to make sure no material is running into basin).	Top slab is free of holes and cracks.
		Frame not sitting flush on top slab, i.e., separation of more than 3/4 inch of the frame from the top slab. Frame not securely attached.	Frame is sitting flush on the riser rings or top slab and firmly attached.
	Fractures or Cracks in Basin Walls/ Bottom	Maintenance person judges that structure is unsound.	Basin replaced or repaired to design standards.
		Grout fillet has separated or cracked wider than 1/2 inch and longer than 1 foot at the joint of any inlet/outlet pipe or any evidence of soil particles entering field inlet through cracks.	Pipe is regouted and secure at basin wall.

Field Inlet			
Drainage System Feature	Potential Defect	Conditions When Maintenance Is Needed	Minimum Performance Standard
Note: table spans multiple pages.			
	Settlement/ Misalignment	If failure of basin has created a safety, function, or design problem.	Basin replaced or repaired to design standards.
	Vegetation Inhibiting System	Vegetation growing across and blocking more than 10% of the basin opening.	No vegetation blocking opening to basin.
		Vegetation growing in inlet/outlet pipe joints that is more than six inches tall and less than six inches apart.	No vegetation or root growth present.
	Contaminants and Pollution	Any evidence of oil, gasoline, contaminants or other pollutants. Sheen, obvious oil or other contaminants present. <ul style="list-style-type: none"> • Identify and remove source, AND • Report to Clark County Clean Water Program. 	No contaminants or pollutants present.
Metal Grates	Grate Not in Place	Cover is missing or only partially in place. Any open field inlet requires maintenance.	Field inlet cover is closed.
	Grate Opening Unsafe	Grate with opening wider than 3 inches.	Grate opening meets design standards.
	Trash and Debris	Trash and debris that is blocking more than 20% of grate surface inletting capacity.	Grate free of trash and debris.
	Damaged or Missing	Grate missing or broken member(s) of the grate.	Grate is in place and meets design standards.

Catch Basin

A catch basin is an underground concrete structure typically fitted with a slotted grate to collect stormwater runoff and route it through underground pipes. Catch basins can also be used as a junction in a pipe system and may have a solid lid. There are two types.

A Type 1 catch basin is a rectangular box with approximate dimensions of 3'x2'x5'. Type 1 catch basins are utilized when the connected conveyance pipes are less than 18 inches in diameter and the depth from the gate to the bottom of the pipe is less than 5 feet.

A Type 2 catch basin, also commonly referred to as a storm manhole, is listed separately under “Manhole” in this book.

Catch basins typically provide a storage volume (sump) below the outlet pipe to allow sediments and debris to settle out of the stormwater runoff. Some catch basins are also fitted with a spill control device (inverted elbow on outlet pipe) intended to contain large quantities of grease or debris.

Catch basins are frequently associated with all stormwater facilities.

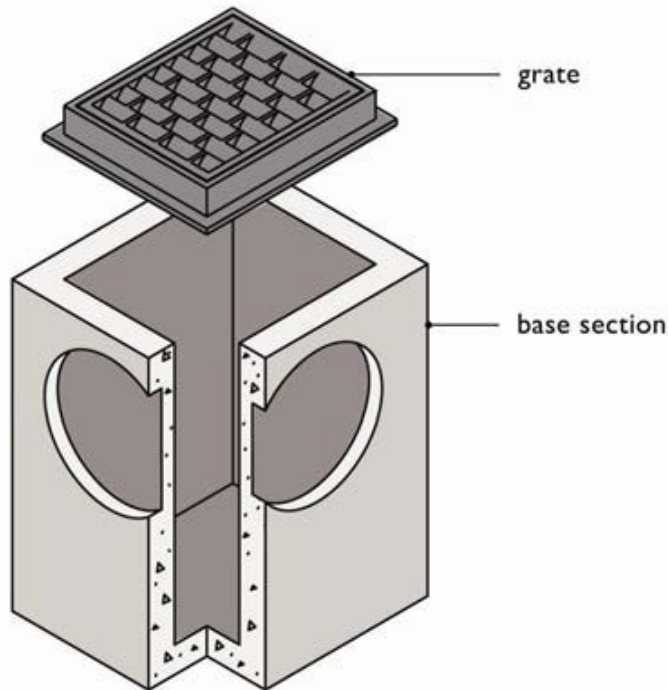

Type I

Key Operations and Maintenance Considerations

- The most common tool for cleaning catch basins is an industrial vacuum truck with a tank and vacuum hose (e.g. Vactor® truck) to remove sediment and debris from the sump.
- A catch basin may be an enclosed space where harmful chemicals and vapors can accumulate. Therefore, if the inspection and maintenance requires entering a catch basin, it should be conducted by an individual trained and certified to work in hazardous confined spaces.

Catch Basin			
Drainage System Feature	Potential Defect	Conditions When Maintenance Is Needed	Minimum Performance Standard
Note: table spans multiple pages.			
General	Trash and Debris	Trash or debris which is located immediately in front of the catch basin opening or is blocking inletting capacity of the basin by more than 10%.	No trash or debris located immediately in front of catch basin or on grate opening.
		Trash or debris (in the basin) that exceeds 60 percent of the sump depth as measured from the bottom of basin to invert of the lowest pipe into or out of the basin, but in no case less than a minimum of six inches clearance from the debris surface to the invert of the lowest pipe.	No trash or debris in the catch basin.
		Trash or debris in any inlet or outlet pipe blocking more than 1/3 of its height.	Inlet and outlet pipes free of trash or debris.
		Dead animals or vegetation that could generate odors that could cause complaints or dangerous gases (e.g., methane).	No dead animals or vegetation present within the catch basin.
	Sediment	Sediment (in the basin) that exceeds 60 percent of the sump depth as measured from the bottom of basin to invert of the lowest pipe into or out of the basin, but in no case less than a minimum of 6 inches clearance from the sediment surface to the invert of the lowest pipe.	No sediment in the catch basin.
	Structure Damage to Frame and/or Top Slab	Top slab has holes larger than 2 square inches or cracks wider than 1/4 inch. (Intent is to make sure no material is running into basin.)	Top slab is free of holes and cracks.
		Frame not sitting flush on top slab, i.e., separation of more than 3/4 inch of the frame from the top slab. Frame not securely attached.	Frame is sitting flush on the riser rings or top slab and firmly attached.
	Fractures or Cracks in	Maintenance person judges that structure is unsound.	Basin replaced or repaired to design standards.

Stormwater Treatment, Flow Control, and Conveyance Facility Components

	Basin Walls/ Bottom	Grout fillet has separated or cracked wider than 1/2 inch and longer than 1 foot at the joint of any inlet/outlet pipe or any evidence of soil particles entering catch basin through cracks.	Pipe is regouted and secure at basin wall.
	Settlement/ Misalignment	If failure of basin has created a safety, function, or design problem.	Basin replaced or repaired to design standards.
	Vegetation Inhibiting System	Vegetation growing across and blocking more than 10% of the basin opening.	No vegetation blocking opening to basin.
		Vegetation growing in inlet/outlet pipe joints that is more than six inches tall and less than six inches apart.	No vegetation or root growth present.
	Contaminants and Pollution	Any evidence of oil, gasoline, contaminants or other pollutants. Sheen, obvious oil or other contaminants present. <ul style="list-style-type: none"> • Identify and remove source, AND • Report to Clark County Clean Water Program. 	No contaminants or pollutants present.
Catch Basin Cover	Cover Not in Place	Cover is missing or only partially in place. Any open catch basin requires maintenance.	Catch basin cover is closed.
	Locking Mechanism Not Working	Mechanism cannot be opened by one maintenance person with proper tools. Bolts into frame have less than 1/2 inch of thread.	Mechanism opens with proper tools.
	Cover Difficult to Remove	One maintenance person cannot remove lid after applying normal lifting pressure (Intent is to keep cover from sealing off access to maintenance).	Cover can be removed by one maintenance person.
Metal Grates (If Applicable)	Grate Opening Unsafe	Grate with opening wider than 7/8 inch.	Grate opening meets design standards.
	Trash and Debris	Trash and debris that is blocking more than 20% of grate surface inletting capacity.	Grate free of trash and debris.
	Damaged or Missing	Grate missing or broken member(s) of the grate.	Grate is in place and meets design standards.
Oil/Debris Trap (If Applicable)	Dislodged	Oil or debris trap is misaligned with or dislodged from the outlet pipe.	Trap is connected to and aligned with outlet pipe.

Manhole

A manhole is an underground concrete structure typically fitted with a slotted grate to collect stormwater runoff and route it through underground pipes. Manholes can also be used as a junction in a pipe system and may have a solid lid. A manhole is also known as a Type 2 catch basin.

Manholes are round concrete structures ranging in diameter from 4 feet to 8 feet. They are used when the connecting conveyance pipe is 18 inches or greater or the depth from grate to pipe bottom exceeds 5 feet. Manholes typically have steps mounted on the side of the structure to allow access.

Manholes typically provide a storage volume (sump) below the outlet pipe to allow sediments and debris to settle out of the stormwater runoff. Some manholes are also fitted with a spill control device (inverted elbow on outlet pipe) intended to contain large quantities of grease or oils.

Manholes are often associated with other stormwater facilities.

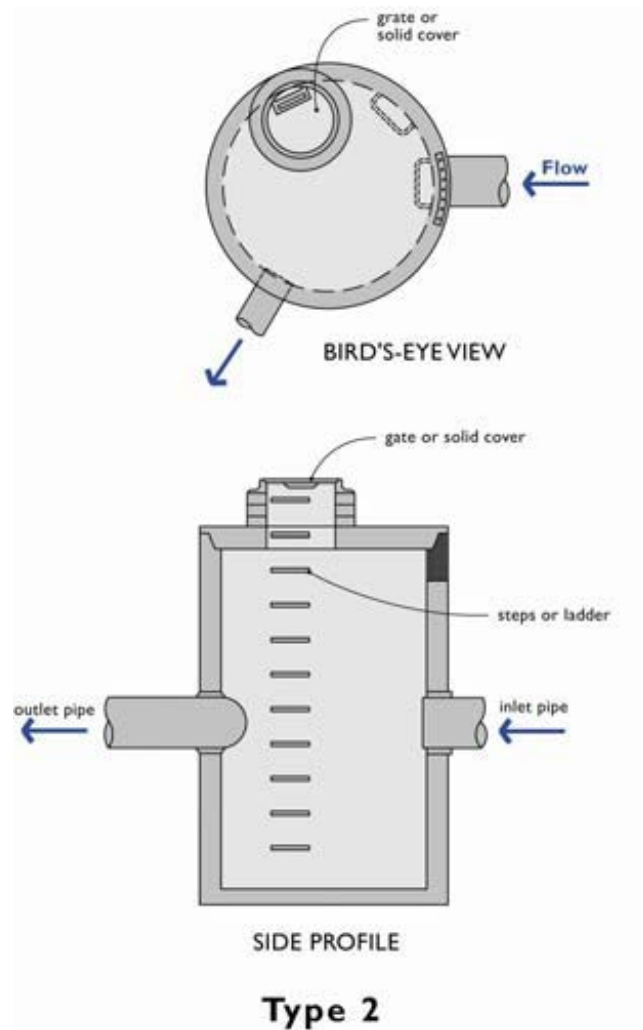

Key Operations and Maintenance Considerations

- The most common tool for cleaning manholes is a truck with a tank and vacuum hose (Vactor® truck) to remove sediment and debris from the sump.
- A manhole may be an enclosed space where harmful chemicals and vapors can accumulate. Therefore, if the inspection and maintenance requires entering a manhole, it should be conducted by an individual trained and certified to work in hazardous confined spaces.

Manhole			
Drainage System Feature	Potential Defect	Conditions When Maintenance Is Needed	Minimum Performance Standard
Note: table spans multiple pages.			
General	Trash and Debris	Trash or debris which is located immediately in front of the opening or is blocking inletting capacity of the basin by more than 10%.	No trash or debris located immediately in front of manhole or on grate opening.
		Trash or debris (in the basin) that exceeds 60 percent of the sump depth as measured from the bottom of basin to invert of the lowest pipe into or out of the basin, but in no case less than a minimum of six inches clearance from the debris surface to the invert of the lowest pipe.	No trash or debris in the basin.
		Trash or debris in any inlet or outlet pipe blocking more than 1/3 of its height.	Inlet and outlet pipes free of trash or debris.
		Dead animals or vegetation that could generate odors that could cause complaints or dangerous gases (e.g., methane).	No dead animals or vegetation present within the catch basin.
	Sediment	Sediment (in the basin) that exceeds 60 percent of the sump depth as measured from the bottom of basin to invert of the lowest pipe into or out of the basin, but in no case less than a minimum of 6 inches clearance from the sediment surface to the invert of the lowest pipe.	No sediment in the basin.
	Structure Damage to Frame and/or Top Slab	Top slab has holes larger than 2 square inches or cracks wider than 1/4 inch. (Intent is to make sure no material is running into manhole.)	Top slab is free of holes and cracks.
		Frame not sitting flush on top slab, i.e., separation of more than 3/4 inch of the frame from the top slab. Frame not securely attached.	Frame is sitting flush on the riser rings or top slab and firmly attached.
	Fractures or Cracks in Basin Walls/ Bottom	Maintenance person judges that structure is unsound.	Basin replaced or repaired to design standards.
		Grout fillet has separated or cracked wider than 1/2 inch and longer than 1 foot at the joint of any inlet/outlet pipe or any evidence of soil particles entering manhole through cracks.	Pipe is regouted and secure at basin wall.

	Settlement/ Misalignment	If failure of manhole has created a safety, function, or design problem.	Manhole replaced or repaired to design standards.
	Vegetation Inhibiting System	Vegetation growing across and blocking more than 10% of the opening.	No vegetation blocking opening to manhole.
		Vegetation growing in inlet/outlet pipe joints that is more than six inches tall and less than six inches apart.	No vegetation or root growth present.
	Contaminants and Pollution	Any evidence of oil, gasoline, contaminants or other pollutants. Sheen, obvious oil or other contaminants present. <ul style="list-style-type: none"> • Identify and remove source, AND • Report to Clark County Clean Water Program. 	No contaminants or pollutants present.
Manhole Cover	Cover Not in Place	Cover is missing or only partially in place. Any open manhole is a safety hazard and requires immediate maintenance.	Manhole cover is closed.
	Locking Mechanism Not Working	Mechanism cannot be opened by one maintenance person with proper tools. Bolts into frame have less than 1/2 inch of thread.	Mechanism opens with proper tools.
	Cover Difficult to Remove	One maintenance person cannot remove lid after applying normal lifting pressure (Intent is to keep cover from sealing off access to maintenance).	Cover can be removed by one maintenance person.
Ladder	Ladder Rungs Unsafe	Ladder is unsafe due to missing rungs, not securely attached to manhole wall, misalignment, rust, cracks, or sharp edges.	Ladder meets design standards and allows maintenance person safe access.
Metal Grates (If Applicable)	Grate Opening Unsafe	Grate with opening wider than 7/8 inch.	Grate opening meets design standards.
	Trash and Debris	Trash and debris that is blocking more than 20% of grate surface inletting capacity.	Grate free of trash and debris.
	Damaged or Missing	Grate missing or broken member(s) of the grate.	Grate is in place and meets design standards.

Catch Basin Insert

Catch basin inserts are used to trap sediment and oil entering catch basins. Most involve some type of filter media and oil-absorbent pads. Filters avoid flooding by overflowing when they become clogged or when there are high storm flows.

Catch basin inserts typically consist of the following components:

- A structure (screened box, brackets, etc.) which contains a pollutant removal medium
- A means of suspending the structure in a catch basin
- A filter medium such as sand, carbon, fabric, etc.
- A primary inlet and outlet for the stormwater
- A secondary outlet for bypassing flows that exceed design flow

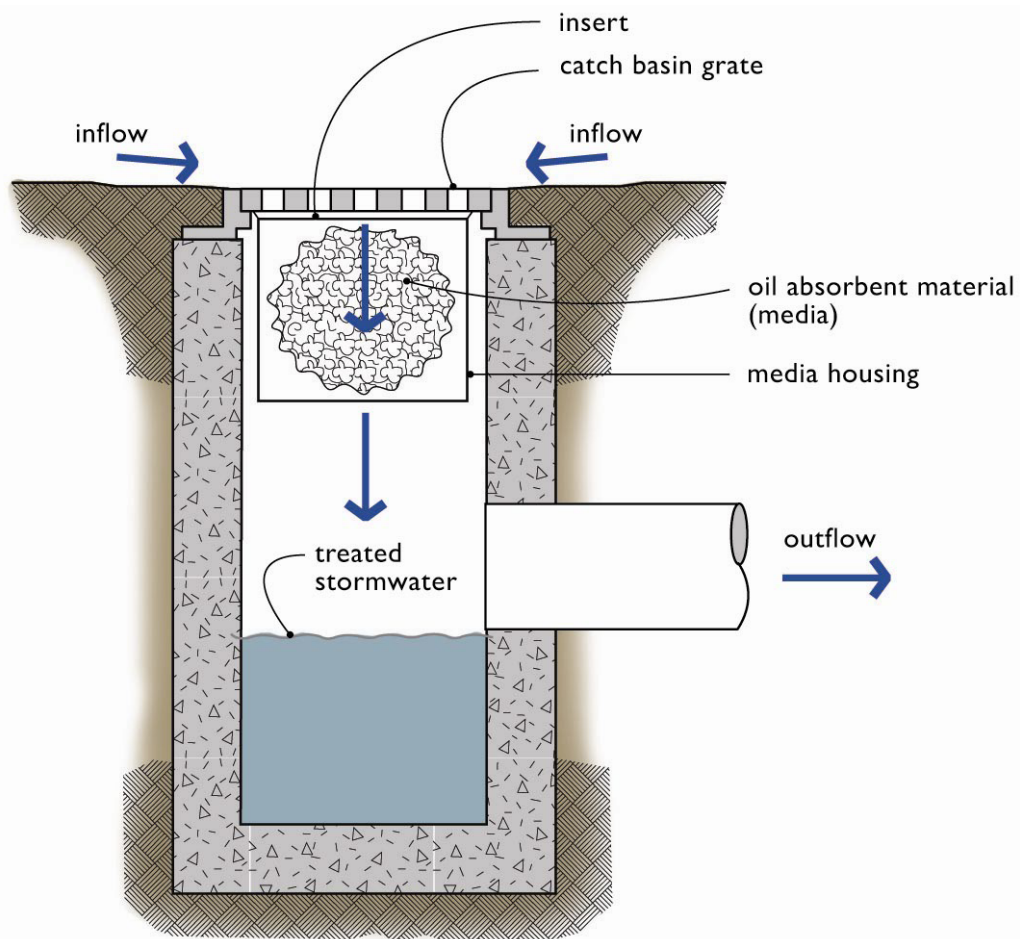

Key Operations and Maintenance Considerations

- Catch basin inserts are proprietary; refer to the manufacturer’s instructions for inspection and maintenance.
- Some catch basin inserts do not require specialized tools and can be removed and replaced by hand.
- See Catch Basins for additional considerations.

Catch Basin Insert			
Drainage System Feature	Potential Defect	Conditions When Maintenance Is Needed	Minimum Performance Standard
General	Sediment Accumulation	When sediment forms a cap over the insert media of the insert and/or unit.	No sediment cap on the insert media and its unit.
	Trash and Debris Accumulation	Trash and debris accumulates on insert unit creating a blockage/restriction.	Trash and debris removed from insert unit. Runoff freely flows into catch basin.
	Media Insert Not Removing Oil	Effluent water from media insert has a visible sheen.	Effluent water from media insert is free of oils and has no visible sheen.
	Media Insert Water Saturated	Catch basin insert is saturated with water and no longer has the capacity to absorb.	Media insert has been replaced.
	Media Insert Oil Saturated	Media oil saturated due to petroleum spill that drains into catch basin.	Media insert has been replaced.
	Media Insert Use Beyond Normal Product Life	Media has been used beyond the typical average life of media insert product.	Media removed and replaced at regular intervals (frequency depending on insert product).

Control Structure/Flow Restrictor

Flow control structures and flow restrictors direct or restrict flow in or out of facility components. Outflow controls on detention facilities are a common example where flow control structures slowly release stormwater at a specific rate. The flow is regulated by a combination of orifices (holes with specifically sized diameters) and weirs (plates with rectangular or “V” shaped notch). Lack of maintenance of the control structure can result in the plugging of an orifice. If these flow controls are damaged, plugged, bypassed, or not working properly, the facility could overtop or release water too quickly.

Control structures have a history of maintenance-related problems and it is imperative to establish a good maintenance program for them to function properly. Sediment typically builds up inside the structure, which blocks or restricts flow to the outlet. To prevent this problem, routinely clean out these structures and conduct regular inspections to detect the need for non-routine cleanout.

Facility objects that are typically associated with a control structure/flow restrictor include:

- detention ponds
- media cartridge filters
- closed detention system
- conveyance stormwater pipe

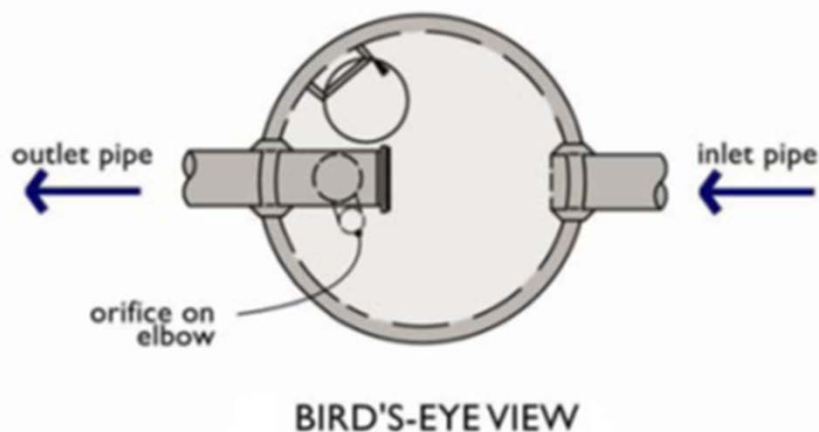

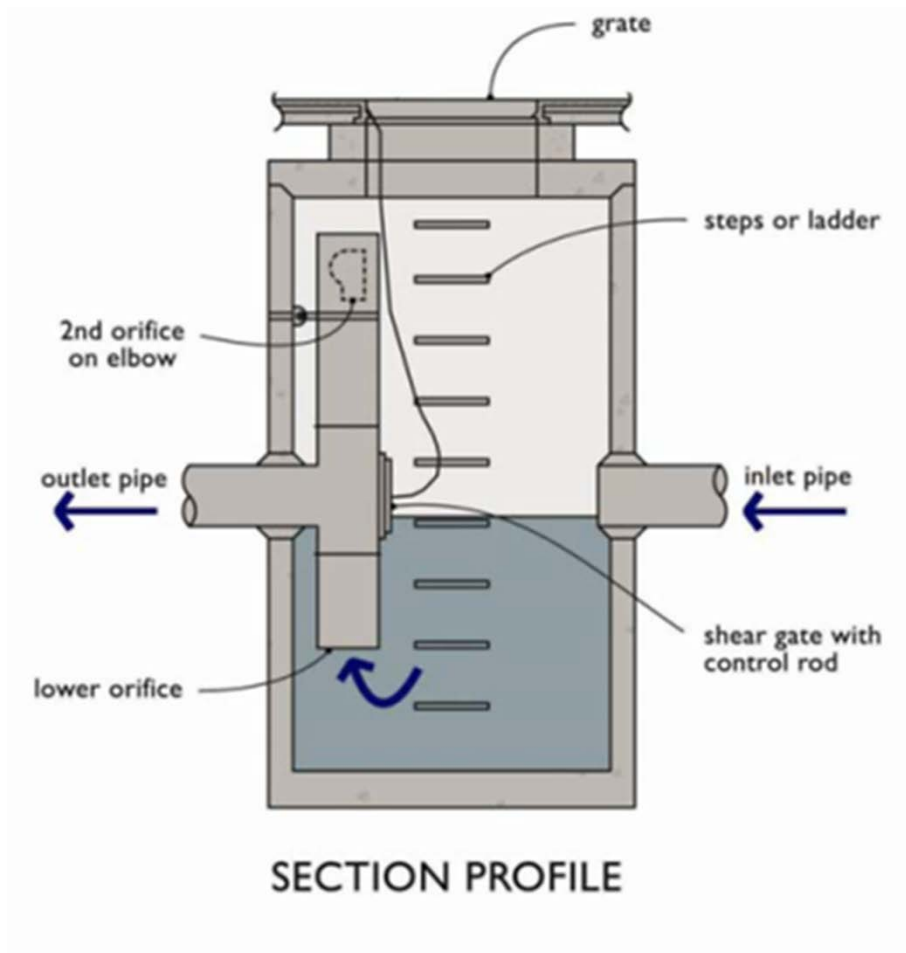

Key Operations and Maintenance Considerations

- Conduct regular inspections of control structures to detect the need for non-routine cleanout, especially if construction or land-disturbing activities occur in the contributing drainage area.
- The most common tool for cleaning control structures/flow restrictors is a truck with a tank and vacuum hose (Vactor® truck) to remove sediment and debris from the sump.
- A control structure is an enclosed space where harmful chemicals and vapors can accumulate. Therefore, if the inspection and maintenance requires entering a control structure, it should be conducted by an individual trained and certified to work in hazardous confined spaces.

Stormwater Treatment, Flow Control, and Conveyance Facility Components

Control Structure/Flow Restrictor			
Drainage System Feature	Potential Defect	Conditions When Maintenance Is Needed	Minimum Performance Standard
General	Trash and Debris (Includes Sediment)	Material exceeds 25% of sump depth or 1 foot below orifice plate.	Control structure orifice is not blocked. All trash and debris has been removed.
	Structural Damage	Structure is not securely attached to manhole wall.	Structure securely attached to wall and outlet pipe.
		Structure is not in upright position (allow up to 10% from plumb).	Structure in correct position.
		Connections to outlet pipe are not watertight and show signs of rust.	Connections to outlet pipe are water tight; structure repaired or replaced and works as designed.
	Any holes--other than designed holes--in the structure.	Structure has no holes other than designed holes.	
Cleanout Gate	Damaged or Missing	Cleanout gate is not watertight or is missing.	Gate is watertight and works as designed.
		Gate cannot be moved up and down by one maintenance person.	Gate moves up and down easily and is watertight.
		Chain/rod leading to gate is missing or damaged.	Chain is in place and works as designed.
		Gate is rusted over 50% of its surface area.	Gate is repaired or replaced to meet design standards.
Orifice Plate	Damaged or Missing	Control device is not working properly due to missing, out of place, or bent orifice plate.	Plate is in place and works as designed.
	Obstructions	Any trash, debris, sediment, or vegetation blocking the plate.	Plate is free of all obstructions and works as designed.
Overflow Pipe	Obstructions	Any trash or debris blocking (or having the potential of blocking) the overflow pipe.	Pipe is free of all obstructions and works as designed.
Manhole	Cover Not in Place	Cover is missing or only partially in place. Any open manhole requires maintenance.	Manhole is closed.
	Locking Mechanism Not Working	Mechanism cannot be opened by one maintenance person with proper tools. Bolts into frame have less than 1/2 inch of thread (may not apply to self-locking lids).	Mechanism opens with proper tools.
	Cover Difficult to Remove	One maintenance person cannot remove lid after applying normal lifting pressure. Intent is to keep cover from sealing off access to maintenance.	Cover can be removed and reinstalled by one maintenance person.
	Ladder Rungs Unsafe	Ladder is unsafe due to missing rungs, misalignment, not securely attached to structure wall, rust, or cracks.	Ladder meets design specifications. Allows maintenance person safe access.
Catch Basins	See "Catch Basins"		

Debris Barrier & Access Barrier (e.g. Trash Rack)

A debris barrier is a bar grate over the open end of a culvert or stormwater conveyance pipe. The intent of a debris barrier is to prevent large materials from entering a closed pipe system. Debris barriers are typically located on the outlet pipe from a detention pond to the control structure. If a debris barrier is not located on an outlet pipe of 18-inch diameter or greater, one should be installed to prevent plugging of the control structure and possible flooding.

An access barrier is installed on a pipe end that is large enough to allow entry. Their function is to prevent debris and unauthorized access into the storm conveyance pipe. Only qualified personnel should attempt to maintain or remove debris from the barrier when water is flowing through the conveyance pipe.

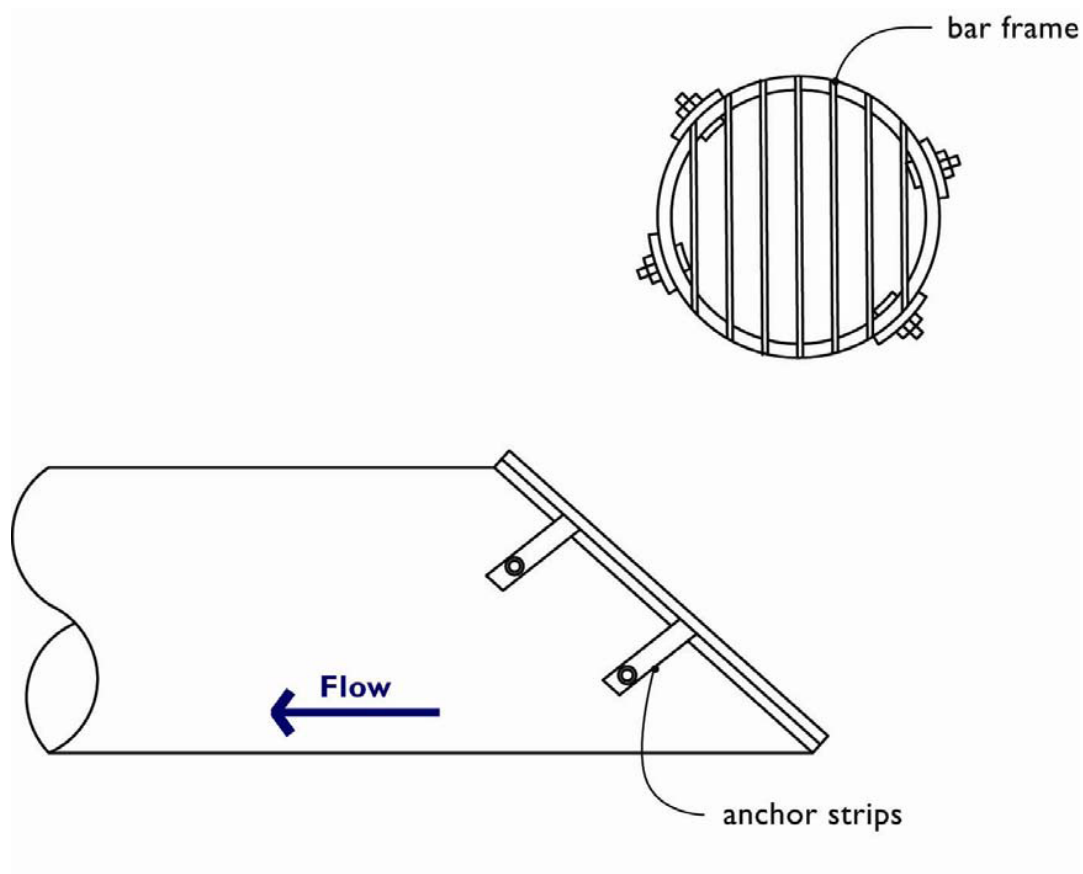

Key Operations and Maintenance Considerations

- The most common tool for cleaning debris and access barriers are hand tools such as a rake to remove collected debris.

Debris Barrier			
Drainage System Feature	Potential Defect	Conditions When Maintenance Is Needed	Minimum Performance Standard
General	Trash and Debris	Trash or debris that is plugging more than 20% of the openings in the barrier.	Barrier cleared to design flow capacity.
	Damaged/ Missing Bars	Bars are bent out of shape more than 3 inches.	Bars in place with no bends more than 3/4 inch.
		Bars are missing or entire barrier missing.	Bars in place according to design specifications.
		Bars are loose and rust is causing 50% deterioration to any part of barrier.	Barrier replaced or repaired to design specifications.
	Missing or Damaged Debris Barrier	Debris barrier missing or not attached to inlet/ outlet pipe.	Barrier is in place and firmly attached to pipe.

Energy Dissipater / Outfall Protection

An energy dissipater is installed on or near the inlet or outlet to a closed pipe system to prevent erosion at these locations. There are a variety of designs, including wire gabion baskets, rock splash pads, trenches, and specially designed pools or manholes. The rock splash pad is typically constructed of 4- to 12-inch diameter rocks a minimum of 12 inches thick and is often lined with filter fabric. The rock pad should extend above the top of the pipe a minimum of 1 foot.

Facility features that are typically associated with energy dissipaters include:

- detention ponds
- infiltration basin
- wetponds
- treatment wetlands

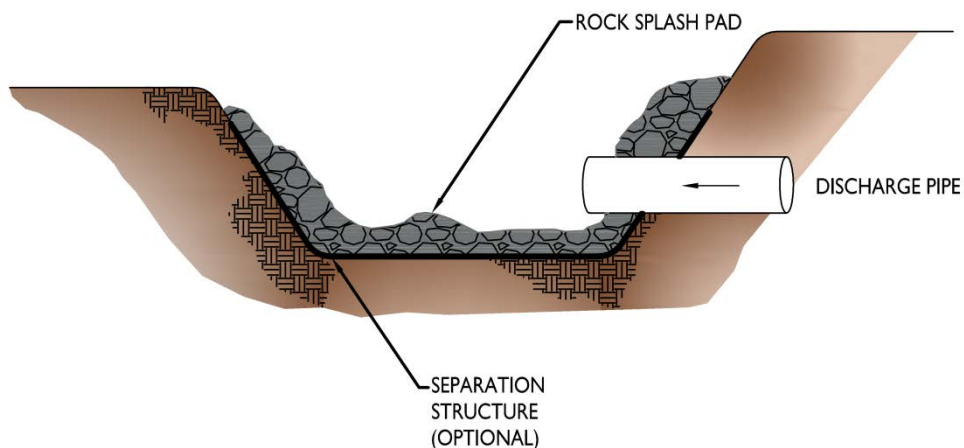

Key Operations and Maintenance Considerations

- The most common tools for maintenance are hand tools such as rakes to redistribute rocks as necessary.
- Periodic removal of sediment or debris may be necessary.

Stormwater Treatment, Flow Control, and Conveyance Facility Components

Energy Dissipaters			
Drainage System Feature	Potential Defect	Conditions When Maintenance Is Needed	Minimum Performance Standard
External:			
Rock Pad	Missing or Moved Rock	Only one layer of rock exists above native soil in area five square feet or larger, or any exposure of native soil.	Rock pad has been replaced to design function.
	Erosion	Soil erosion in or adjacent to rock pad.	Rock pad has been replaced to design function.
	Sediment	Sediment on top of rock pad exceeds 10% of the surface.	Rock pad has been cleared of sediment.
	Poisonous Plants and Noxious Weeds	Any poisonous plants or nuisance vegetation which may constitute a hazard to maintenance personnel or the public. Any evidence of noxious weeds as defined by State or local regulations. (Coordinate with Clark County Environmental Services Department, Vegetation Management Program.)	No danger of poisonous vegetation where maintenance personnel or the public might normally be. Eradication of Class A weeds as required by State law. Control of Class B weeds designated by Clark County Weed Board. Control of other listed weeds as directed by local policies. Apply requirements of adopted IPM policy for the use of herbicides.
	Other Weeds	Other weeds (not listed on County/State noxious weed lists) are present on the rock pad.	Weeds have been removed per the routine maintenance schedule, following IPM protocols.
Dispersion Trench	Pipe Plugged with Sediment	Accumulated sediment that exceeds 20% of the design depth.	Pipe is free of sediment and meets design specifications.
	Not Discharging Water Properly	Visual evidence of water discharging at concentrated points along trench (normal condition is a "sheet flow" of water along trench). Intent is to prevent erosion damage.	Trench has been repaired or modified such that it does not discharge at concentrated points and meets design function.
	Perforations Plugged	Over 1/2 of perforations in pipe are plugged with debris and sediment.	Perforated pipe has been cleaned or replaced and <25% of perforations are plugged.
	Water Flows Out Top of "Distributor" Catch Basin	Maintenance person observes or receives credible report of water flowing out during any storm less than the design storm or its causing or appears likely to cause damage.	Facility rebuilt per design specifications or redesigned to meet approved County standards.
	Receiving Area Over-Saturated	Water in receiving area is causing or has potential of causing landslide problems.	No danger of landslides.
Internal:			
Manhole/ Chamber	Worn or Damaged Post, Baffles, Side of Chamber	Structure dissipating flow deteriorates to 1/2 of original size or any concentrated worn spot exceeding one square foot which would make structure unsound.	Structure replaced to design standards.
Catch Basins	See "Catch Basins"		

Stormwater Conveyance Pipe

Storm sewer pipes convey stormwater. Inlet and outlet stormwater pipes convey stormwater in, through, and out of stormwater facilities.

Pipes are built from many materials and are sometimes perforated to allow stormwater to infiltrate into the ground. Pipes are cleaned to remove sediment or blockages when problems are identified. Stormwater pipes must be clear of obstructions and breaks to prevent localized flooding. All stormwater pipes should be in proper working order and free of the possible defects listed below.

Key Operations and Maintenance Considerations

- The most common tool for cleaning stormwater conveyance pipes is a truck with a tank, vacuum hose, and a jet hose (Vactor® truck) to flush sediment and debris from the pipes.

Stormwater Conveyance Pipe			
Drainage System Feature	Potential Defect	Conditions When Maintenance Is Needed	Minimum Performance Standard
General	Contaminants and Pollution	Any evidence of oil, gasoline, contaminants or other pollutants. Sheen, obvious oil or other contaminants present. <ul style="list-style-type: none"> Identify and remove source, AND Report to Clark County Clean Water Program. 	No contaminants or pollutants present.
	Drainage Slow	Decreased capacity that indicates slow drainage. Does not meet facility design infiltration rate. The Water Quality Design Storm Volume does not infiltrate within 48 hours (if perforated pipe). Water remains in the pipe for greater than 24 hours after the end of most moderate rainfall events.	Perforated drain pipe has been cleaned and drainage rates are per design specifications. (Do not allow removed sediment and water to discharge back into the storm sewer.)
	Obstructions, Including Roots	Root enters or deforms pipe, reducing flow.	Roots have been removed from pipe (using mechanical methods; do not put root-dissolving chemicals in storm sewer pipes). If necessary, vegetation over the line removed.
	Pipe Dented or Broken	Inlet/outlet piping damaged or broken and in need of repair.	Pipe repaired and/or replaced per design standards.
	Pipe Rusted or Deteriorated	Any part of the piping that is crushed or deformed more than 20% or any other failure to the piping.	Pipe repaired and/or replaced per design standards.
	Sediment & Debris	Sediment depth is greater than 20% of pipe diameter.	Pipe has been cleaned and is free of sediment/ debris. (Upstream debris traps installed where applicable.)
	Debris Barrier or Trash Rack Missing	Stormwater pipes > than 18 inches need debris barrier.	Debris barrier present on all stormwater pipes 18 inches and greater.

Stormwater Facility Discharge Points / Pipe Outlets

Stormwater facility discharge points may convey stormwater from the stormwater facility into open channels, ditches, ponds, streams, and wetlands. Stormwater facility discharge points need to be assessed to make sure stormwater is not causing any negative impacts to these drainage areas.

Key Operations and Maintenance Considerations

- The most common tools are hand tools to remove debris or to redistribute outfall protection rock.



(Source: USDA - Natural Resources Conservation Service - Illinois)

Facility Discharge Point			
Drainage System Feature	Potential Defect	Conditions When Maintenance Is Needed	Minimum Performance Standard
Monitoring	Contaminants in Discharge Water	Any evidence of oil, gasoline, contaminants or other pollutants. Sheen, obvious oil or other contaminants present. <ul style="list-style-type: none"> Identify and remove source, AND Report to Clark County Clean Water Program. 	Effluent discharge from facility is clear.
	Receiving Area Saturated	Water in receiving area is causing substrate to become saturated and unstable. <ul style="list-style-type: none"> Report to Clark County Clean Water Program for Engineer Evaluation. 	Receiving area is sound and not saturated.
	Ditch or Stream Banks Eroding (via Off Site Assessment)	Erosion, scouring, or headcuts in ditch or stream banks downstream of facility discharge point due to flow channelization or higher flows. <ul style="list-style-type: none"> Report to Clark County Clean Water Program for Engineer Evaluation. 	Ditch or stream banks are stable.
General	Missing or Moved Rock	Only one layer of rock exists above native soil in area five square feet or larger, or any exposure of native soil.	Rock pad replaced to design function.
	Erosion	Soil erosion in or adjacent to rock pad.	Rock pad replaced to design function.
	Obstructions, Including Roots	Roots or debris enters pipe or deforms pipe, reducing flow.	Roots have been removed from pipe (using mechanical methods; do not put root-dissolving chemicals in storm sewer pipes). If necessary, vegetation over the line removed.
	Pipe Rusted or Deteriorated	Any part of the pipe that is broken, crushed or deformed more than 20% or any other failure to the piping.	Pipe repaired or replaced to design standards.
Internal (If Applicable)			
Energy Dissipater	See "Energy Dissipater"		

Hydrodynamic Separator System

A hydrodynamic separator is a structure with a cylindrical vessel where the incoming stormwater flow spirals around the perimeter causing the heavier particles to settle out of the stormwater. It uses a vortex-enhanced settling mechanism (swirl-concentration) to capture settleable solids, floatables, and oil and grease.

Vortechs® treatment units are an example of a proprietary hydrodynamic separator system. See manufacturer's publications for additional maintenance information.

Facility objects that are often associated with a hydrodynamic separator system include:

- access road or easement
- control structure/flow restrictor
- manufactured media filter (such as a StormFilter® system)
- conveyance stormwater pipe

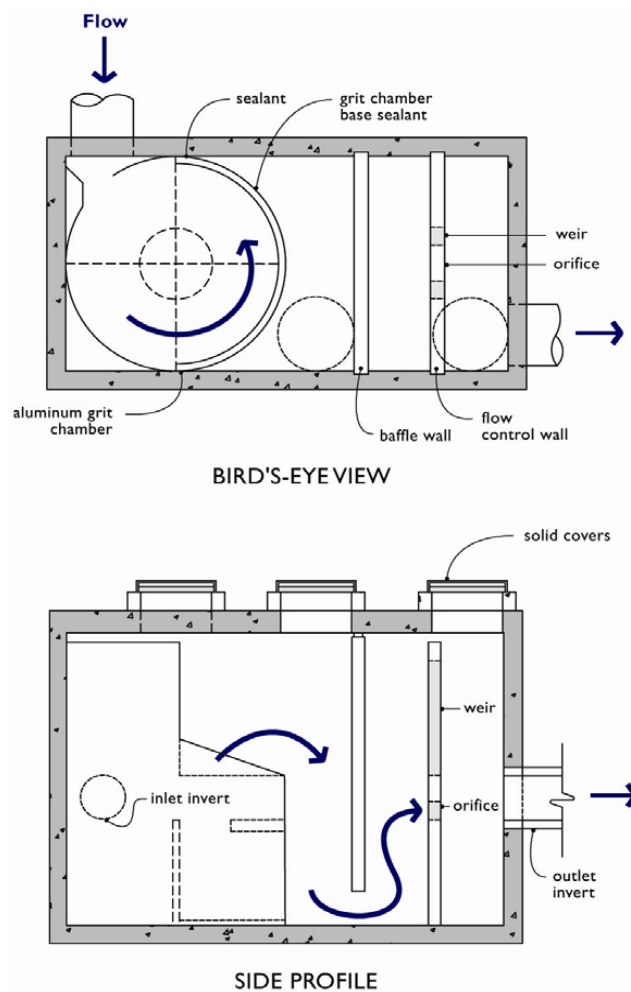

Key Operations and Maintenance Considerations

- The most common tool for cleaning hydrodynamic separators is a truck with a tank and vacuum hose (Vactor® truck) to remove sediment and debris from the sediment chamber / sump.
- See manufacturer's publications for additional maintenance information.

Hydrodynamic Separator System			
Drainage System Feature	Potential Defect	Conditions When Maintenance Is Needed	Minimum Performance Standard
General	Sediment Accumulation	Sediment depth is within 12 through 18" of dry weather water surface elevation.	Accumulated sediment has been removed.
	Trash and Debris Accumulation	Trash and debris accumulated in vault, or pipe inlet/outlet, floatables and non-floatables.	Trash and debris has been removed from vault, and inlet/outlet piping.
	Oil Accumulation	Oil accumulation that exceeds 1- inch at the water surface.	Oil has been extracted from vault. Coalescing plates have been cleaned. No visible oil depth on water.
	Damaged Pipes	Inlet or outlet piping damaged or broken and in need of repair.	Pipe has been repaired and / or replaced.
	Defects in Baffles	Baffles corroding, cracking, warping and/or showing signs of failure as determined by maintenance/inspection person.	Baffles repaired or replaced to design specifications.
	Vault Structure Damage - Includes Cracks in Walls, Bottom, Damage to Frame and/or Top Slab	Cracks wider than 1/2-inch or evidence of soil particles entering the structure through the cracks, or maintenance/inspection personnel determine that the vault is not structurally sound.	Vault replaced or repairs made so that vault meets design specifications and is structurally sound.
		Cracks wider than 1/2-inch at the joint of any inlet/ outlet pipe or evidence of soil particles entering through the cracks.	Vault repaired so that no cracks exist wider than 1/4-inch at the joint of the inlet/ outlet pipe.
	Sediment in Drain Pipes/Clean-Outs	When drain pipes, clean-outs, become full with sediment and/or debris.	Sediment and debris removed.
Access Ladder Damaged	Ladder is corroded or deteriorated, not functioning properly, not securely attached to structure wall, missing rungs, cracks, and misaligned.	Ladder replaced or repaired, meets design specifications, and is safe to use as determined by inspection personnel.	

Sediment Trap

A sediment trap is a concrete structure typically fitted with a slotted grate or multiple slotted grates (debris barriers). The concrete structure provides a storage volume (sump) below the outlet pipe to allow sediments and debris to settle out of the stormwater runoff. Some sediment traps are fitted with a spill control device (elbow on outlet pipe) intended to help direct and dissipate flow. The slotted grate (debris barrier) prevents larger debris from exiting the level spreader.

Facility objects that are often associated with a sediment trap include:

- access road or easement
- fence, gate, and water quality sign
- typical bioswale
- wet bioswale

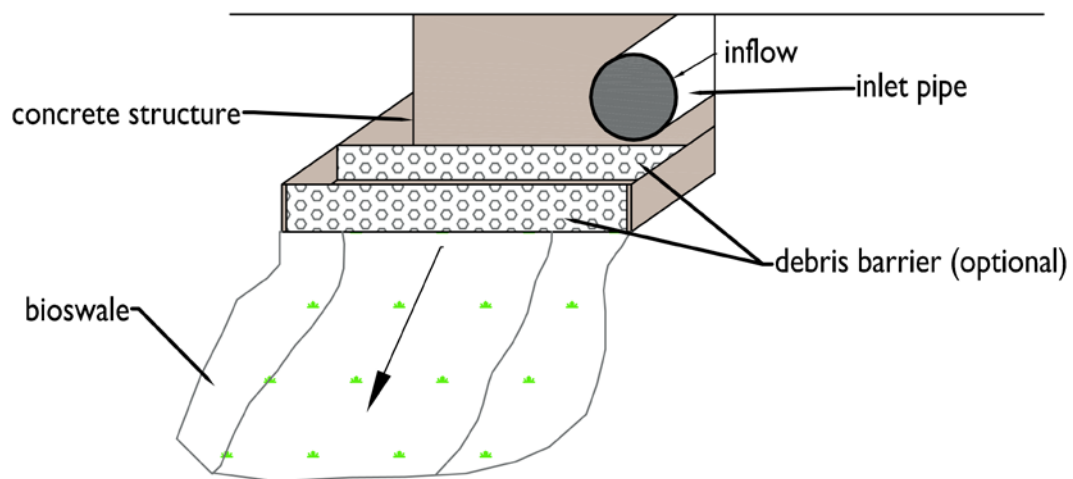

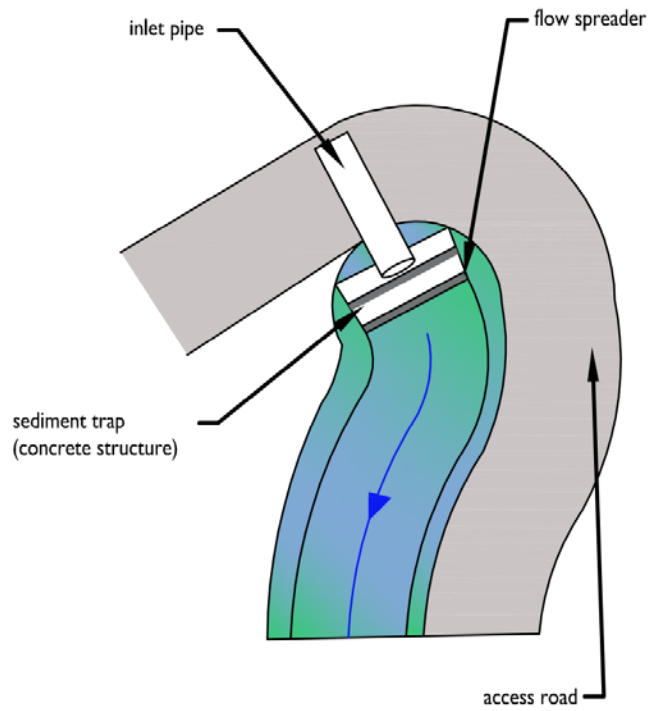

Sediment Trap with Accumulated Sediment

Key Operations and Maintenance Considerations

- The most common tool for cleaning sediment traps is a truck with a tank and vacuum hose (Vactor® truck) to remove sediment and debris from the sump area. Hand tools (e.g. rake, broom, square shovel) are also commonly used for cleaning.

Sediment Trap			
Drainage System Feature	Potential Defect	Conditions When Maintenance is Needed	Minimum Performance Standard
Note: table spans multiple pages.			
General	Trash and Debris	Trash or debris which is located immediately in front of the sediment trap opening or is blocking inletting capacity of the basin by more than 10%.	No trash or debris located immediately in front of sediment trap or on grate opening.
		Trash or debris (in the basin) that exceeds 60 percent of the sump depth as measured from the bottom of basin to invert of the lowest pipe into or out of the basin.	No trash or debris in the sediment trap.
		Trash or debris in any inlet or outlet pipe blocking more than 1/3 of its height.	Inlet and outlet pipes free of trash or debris.
		Dead animals or vegetation that could generate odors that could cause complaints or dangerous gases (e.g., methane).	No dead animals or vegetation present within the sediment trap.
	Sediment	Sediment (in the basin) that exceeds 60 percent of the sump depth as measured from the bottom of basin to invert of the lowest pipe into or out of the basin .	No sediment in the sediment trap.
	Structure Damage to Frame and/or Top Slab	Slab has holes larger than 2 square inches or cracks wider than 1/4 inch. (Intent is to make sure no material is running into basin.)	Structure is free of holes and cracks.
	Fractures or Cracks in Basin Walls/ Bottom	Maintenance person judges that structure is unsound.	Sediment trap replaced or repaired to meet design specifications.
		Grout fillet has separated or cracked wider than 1/2 inch and longer than 1 foot at the joint of any inlet/outlet pipe or any evidence of soil particles entering catch basin through cracks.	Pipe is regouted and secure at basin wall.
	Settlement/ Misalignment	If failure of basin has created a safety, function, or design problem.	Sediment trap replaced or repaired to design specifications.

Sediment Trap			
Drainage System Feature	Potential Defect	Conditions When Maintenance is Needed	Minimum Performance Standard
Note: table spans multiple pages.			
	Vegetation	Vegetation growing across and blocking more than 10% of the basin opening.	No vegetation blocking opening to sediment trap.
	Contaminants and Pollution	Any evidence of oil, gasoline, contaminants or other pollutants. (Coordinate removal/cleanup with local water quality response agency.)	No contaminants or pollutants present.
Debris Barrier (optional)	Trash and Debris	Trash and debris that is blocking more than 20% of grate surface inletting capacity.	Grate free of trash and debris.
	Damaged or Missing	Grate missing or broken member(s) of the grate.	Grate is in place and meets design standards.

Oil/Water Separator (API Type)

This type of oil/water separator is a design from American Petroleum Institute (API). An oil/water separator is an underground vault that treats stormwater by mechanically separating oil from water. The oil rises to the surface and floats on the water and sediment settles to the bottom. Oil/water separators are typically utilized in locations where high oil concentrations in the stormwater runoff are anticipated (e.g. service and fuel stations). Oil/water separators are most commonly used as the first pretreatment facility in a series of stormwater management facilities.

Facility objects that are typically associated with an oil/water separator include:

- access road or easement
- control structure/flow restrictor

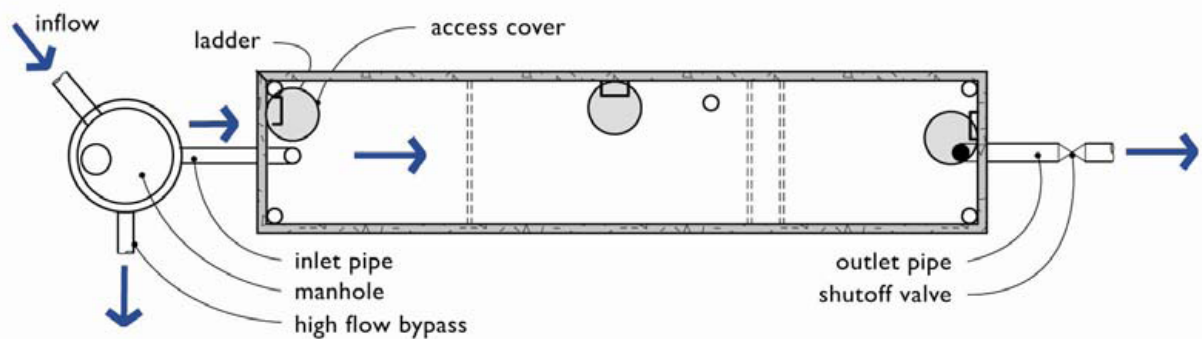

BIRD'S-EYE VIEW

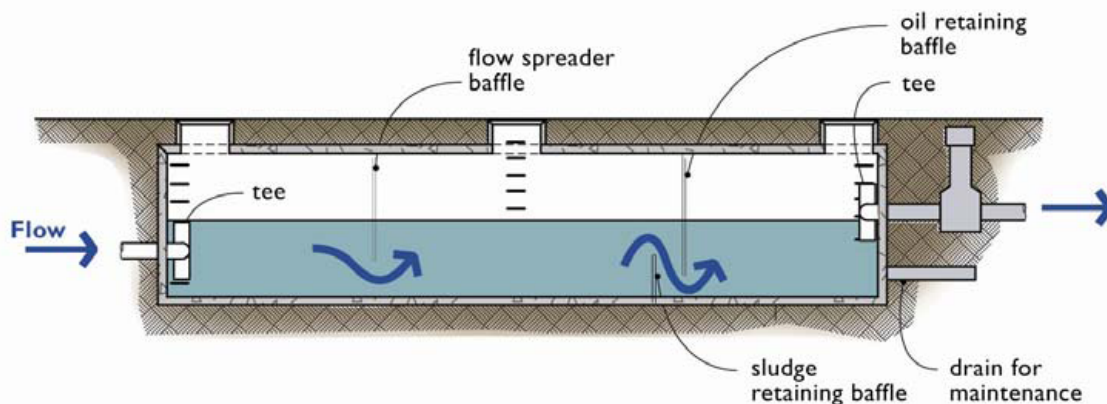

SIDE PROFILE

Key Operations and Maintenance Considerations

- Common tools for cleaning and maintaining an oil/water separator are a vacuum truck and/or oil absorbing media materials to remove oils and other sediments that have accumulated in the facility.
- Prepare, regularly update, and implement an O&M Manual for the oil/water separators.
- Inspect oil/water separators to ensure proper operation monthly during the wet season of October 1 - April 30 and during and immediately after a large storm event of ≥ 1 inch per 24 hours.
- Clean oil/water separators regularly to keep accumulated oil from escaping during storms. They must be cleaned by October 15 to remove material that has accumulated during the dry season, after all spills, and after a significant storm. An eductor truck may be used for oil, sludge, and washwater removal. Replace wash water in the separator with clean water before returning it to service.
- Replace oil absorbent pads before their absorbed oil content reaches capacity.
- Train designated employees on appropriate separator operation, inspection, record keeping, and maintenance procedures.

Oil/Water Separator (API Type)			
Drainage System Feature	Potential Defect	Conditions When Maintenance Is Needed	Minimum Performance Standard
Note: table spans multiple pages.			
General	Poor Water Quality	Inspection of discharge water for obvious signs of poor water quality (i.e. obvious oil or other contaminants present).	Effluent discharge from vault is clear, without thick visible sheen.
	Sediment Accumulation	Sediment depth in bottom of vault exceeds 6-inches in depth.	No sediment deposits on vault bottom that would impede flow through the vault and reduce separation efficiency.
	Trash and Debris Accumulation	Trash and debris accumulation in vault, or pipe inlet/outlet, floatables and non-floatables.	Vault and inlet/outlet piping free of trash and debris.
	Oil Accumulation	Oil accumulations that exceed 1-inch, at the surface of the water.	Oil extracted from vault by vacuuming. Disposal in accordance with state and local rules and regulations.
	Damaged Pipes	Inlet or outlet piping damaged or broken and in need of repair.	Pipe repaired or replaced to design specifications.
	Access Cover Damaged/Not Working	Cover cannot be opened, corrosion/deformation of cover.	Cover repaired or replaced to design specifications.

Stormwater Treatment, Flow Control, and Conveyance Facility Components

Oil/Water Separator (API Type)			
Drainage System Feature	Potential Defect	Conditions When Maintenance Is Needed	Minimum Performance Standard
Note: table spans multiple pages.			
	Vault Structure Damage - Includes Cracks in Walls Bottom, Damage to Frame and/or Top Slab	Top slab has holes larger than 2 square inches or cracks wider than 1/4 inch. (Intent is to make sure no material is running into basin.)	Top slab is free of holes and cracks.
		Frame not sitting flush on top slab, i.e., separation of more than 3/4 inch of the frame from the top slab. Frame not securely attached.	Frame is sitting flush on the riser rings or top slab and firmly attached.
		Maintenance person judges that structure is unsound.	Basin replaced or repaired to design standards.
		Grout fillet has separated or cracked wider than 1/2 inch and longer than 1 foot at the joint of any inlet/outlet pipe or any evidence of soil particles entering catch basin through cracks.	Pipe is regouted and secure at basin wall.
		If failure of basin has created a safety, function, or design problem.	Basin replaced or repaired to design standards.
		Cracks wider than 1/2-inch at the joint of any inlet/outlet pipe or evidence of soil particles entering through the cracks.	Vault repaired so that no cracks exist wider than 1/4-inch at the joint of the inlet/outlet pipe.
	Baffles	Baffles corroding, cracking, warping and/or showing signs of failure as determined by maintenance/inspection person.	Baffles repaired or replaced to design specifications.
Access Ladder Damaged	Ladder is corroded or deteriorated, not functioning properly, not securely attached to structure wall, missing rungs, cracks, and misaligned.	Ladder replaced or repaired, meets design specifications, and is safe to use as determined by inspection personnel.	

Coalescing Plate Oil/Water Separator

A coalescing plate oil/water separator is generally the same as the API type. The main difference is that coalescing plate separators include a series of parallel plates in the separation bay (2nd bay) that increase the oil removal efficiency of the separator.

Facility objects associated with a coalescing plate oil/water separator may include:

- access road or easement
- control structure/flow restrictor
- conveyance stormwater pipe

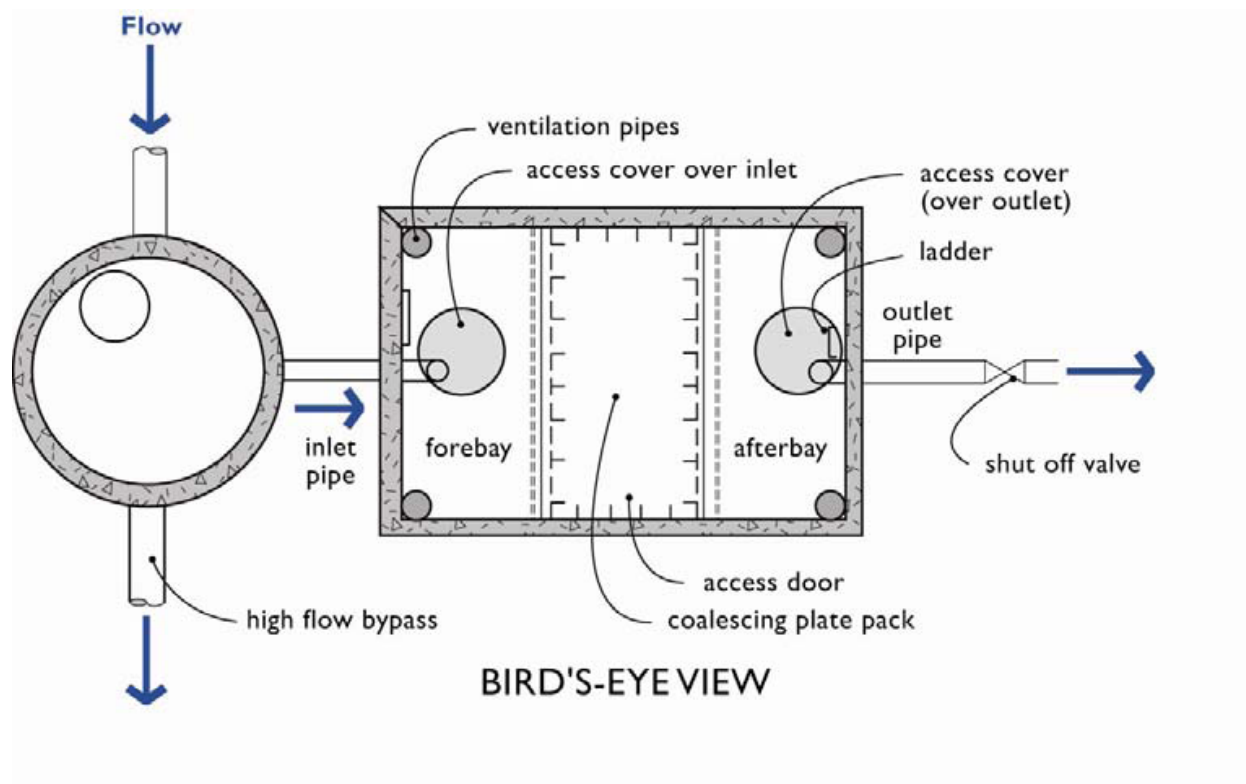

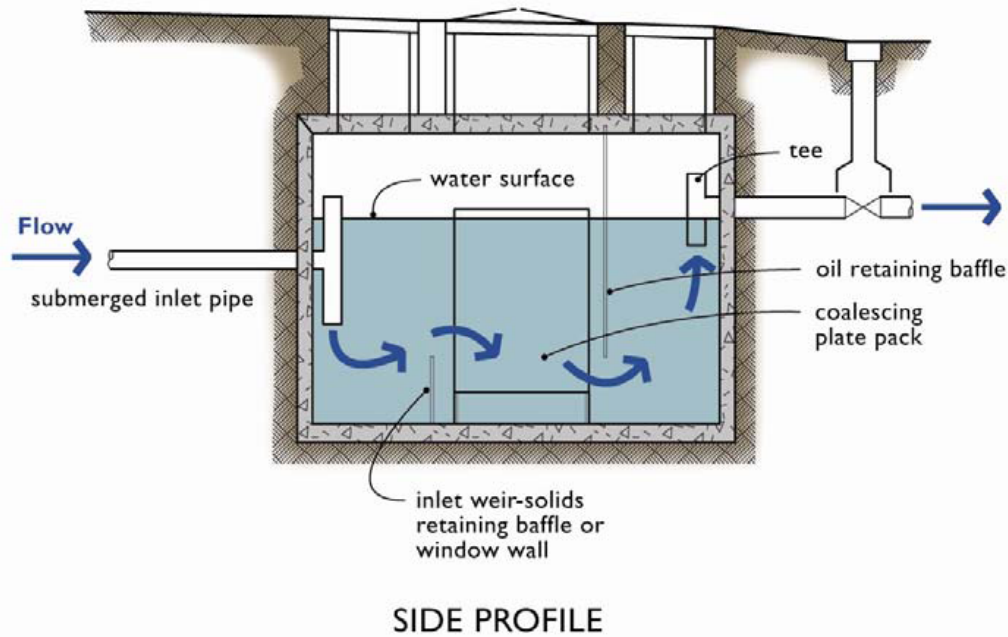

Key Operations and Maintenance Considerations

- Prepare, regularly update, and implement an O&M Manual for the oil/water separators.
- Inspect oil/water separators to ensure proper operation monthly during the wet season of October 1 - April 30 and during and immediately after a large storm event of ≥ 1 inch per 24 hours.
- Clean oil/water separators regularly to keep accumulated oil from escaping during storms. They must be cleaned by October 15 to remove material that has accumulated during the dry season, after all spills, and after a significant storm. Coalescing plates may be cleaned in-situ or after removal from the separator. An eductor truck may be used for oil, sludge, and washwater removal. Replace wash water in the separator with clean water before returning it to service.
- Replace oil absorbent pads before their absorbed oil content reaches capacity.
- Train designated employees on appropriate separator operation, inspection, record keeping, and maintenance procedures.
- Common tools for cleaning and maintaining an oil/water separator are a vacuum truck and/or oil absorbing media materials to remove oils and other sediments that have accumulated in the facility.

Coalescing Plate Oil/Water Separator			
Drainage System Feature	Potential Defect	Conditions When Maintenance Is Needed	Minimum Performance Standard
General	Poor Water Quality	Inspection of discharge water for obvious signs of poor water quality (i.e. obvious oil or other contaminants present).	Effluent discharge from vault clear with no thick visible sheen.
	Sediment Accumulation	Sediment depth in bottom of vault exceeds 6-inches in depth and/or visible signs of sediment on plates.	No sediment deposits on vault bottom and plate media that would impede flow through the vault and reduce separation efficiency.
	Trash and Debris Accumulation	Trash and debris accumulated in vault, or pipe inlet/outlet, floatables and non-floatables.	Vault and inlet/ outlet piping is free of trash and debris.
	Oil Accumulation	Oil accumulation that exceeds 1-inch at the water surface.	Oil has been extracted from vault. Coalescing plates have been cleaned. No visible oil depth on water.
	Damaged Coalescing Plates	Plate media broken, deformed, cracked and/or showing signs of failure.	A portion of the media pack or the entire plate pack has been replaced (depending on severity of failure).
	Damaged Pipes	Inlet or outlet piping damaged or broken and in need of repair.	Pipe has been repaired and or replaced to design specifications.
	Baffles	Baffles corroding, cracking, warping and/or showing signs of failure as determined by maintenance/inspection person.	Baffles have been repaired or replaced to design specifications.
	Vault Structure Damage - Includes Cracks in Walls, Bottom, Damage to Frame and/or Top Slab	Cracks wider than 1/2-inch or evidence of soil particles entering the structure through the cracks, or maintenance/inspection personnel determine that the vault is not structurally sound.	Vault replaced or repairs made so that vault meets design specifications and is structurally sound.
		Cracks wider than 1/2-inch at the joint of any inlet/outlet pipe or evidence of soil particles entering through the cracks.	Vault repaired so that no cracks exist wider than 1/4-inch at the joint of the inlet/outlet pipe.
Access Ladder Damaged	Ladder is corroded or deteriorated, not functioning properly, not securely attached to structure wall, missing rungs, cracks, and misaligned.	Ladder replaced or repaired, meets design specifications, and is safe to use as determined by inspection personnel.	

Presettling Basin (Forebay or Pretreatment)

A presettling basin is a closed or open basin, preceding another treatment or flow control facility, which retains a permanent pool of water (wetpool) year round or during the wet season. The presettling basin allows solids and sediments to settle out of stormwater before water moves to the subsequent basin for infiltrations or further treatment.

Facility objects associated with a presettling basin may include:

- access road or easement
- inlet
- catch basin
- berm or baffle
- control structure/flow restrictor

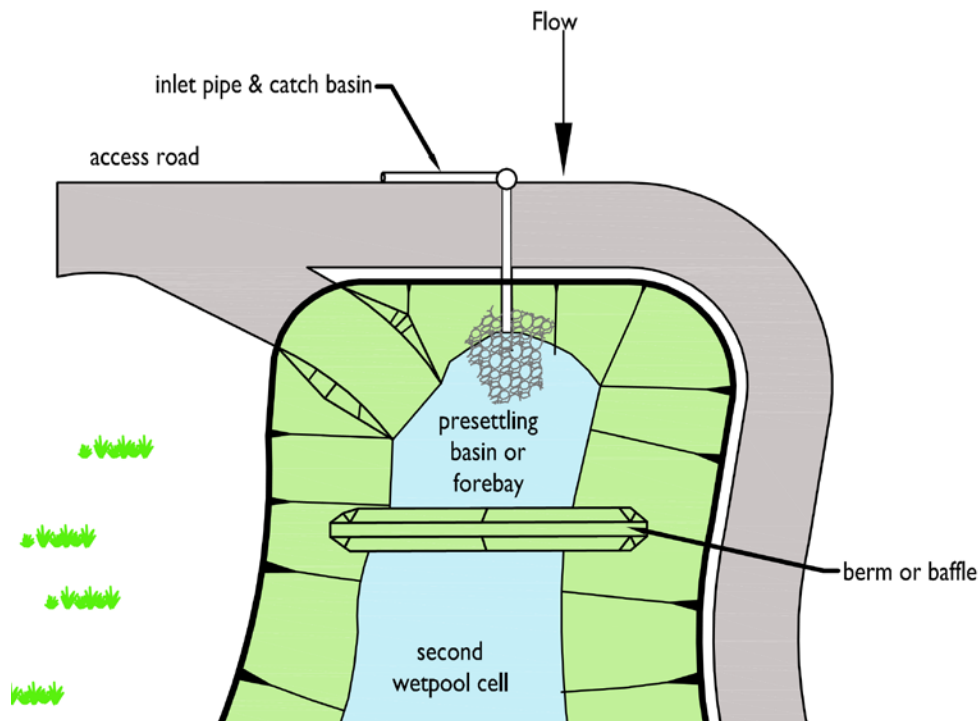

Key Operations and Maintenance Considerations

- Slope areas that have become bare should be revegetated and eroded areas should be regraded prior to being revegetated.
- Sediment must be disposed in accordance with current local health department requirements and the Minimum Functional Standards for Solid Waste Handling. For additional guidance see [Book 3, Appendix 3-E](#), Recommendations for Management of Street Waste.

- Any standing water removed during the maintenance operation must be properly disposed of. The preferred disposal option is discharge to a sanitary sewer at an approved location. Other disposal options include discharge back into the wetpool facility or the storm sewer system if certain conditions are met. For additional guidance see [Book 3, Appendix 3-E, Recommendations for Management of Street Waste.](#)

Presettling Basin			
Drainage System Feature	Potential Defect	Conditions When Maintenance Is Needed	Minimum Performance Standard
General	Water level	First cell is empty, doesn't hold water.	First cell lined to maintain at least 4 feet of water. Although the second cell may drain, the first cell must remain full to control turbulence of the incoming flow and reduce sediment resuspension.
	Trash and Debris	Accumulation that exceeds 1 CF per 1000-SF of pond area.	Trash and debris removed from pond.
	Sediment Accumulation in Pond Bottom	Cattail or other emergent, rooted vegetation covers 50% of the basin surface area AND there is clear indication that stormwater inflow or facility effectiveness is being impeded.	Remove vegetation and sediment in the Presettling Cell as necessary so that: Remaining vegetation covers no more than 25% of the basin surface area; Inflow not impeded;. Generally retain vegetation at wetland or wet pond boundary.
	Oil Sheen on Water	Any evidence of oil, gasoline, contaminants or other pollutants. Sheen, obvious oil or other contaminants present. <ul style="list-style-type: none"> Identify and remove source, AND Report to Clark County Clean Water Program. 	Oil not present on pond surface. Oil has been removed from water using oil-absorbent pads or Vactor® truck. Source of oil located and corrected. If chronic low levels of oil persist, plant wetland plants such as Juncus effusus (soft rush) which can uptake small concentrations of oil.
	Erosion	Erosion of the basin's side slopes and/or scouring of the pond bottom that exceeds 6-inches, or where continued erosion is prevalent.	Slopes stabilized using proper erosion control measures and repair methods.
	Settlement of Pond Dike/Berm	Any part of these components that has settled 4-inches or lower than the design elevation, or inspector determines dike/berm is unsound.	Dike/berm is repaired to design specifications.
	Internal Berm	Berm dividing cells should be level.	Berm surface is leveled so that water flows evenly over entire length of berm.

Detention Pond

A stormwater detention pond is an open basin built by excavating below existing ground or by constructing above-ground berms (embankments). The detention pond temporarily stores stormwater runoff during rain events and slowly releases it through an outlet (control structure). Detention ponds are typically designed to completely drain within 24 hours after the completion of a storm event. Styles vary greatly from well-manicured to natural appearing. Generally, more natural-appearing vegetation is preferred for reduced maintenance and enhanced wildlife habitat.

Facility objects that are typically associated with a detention pond include:

- access road or easement
- fence, gate, and water quality sign
- typical bioswale
- wet bioswale
- media filter cartridge
- control structure/flow restrictor
- energy dissipaters
- conveyance stormwater pipe

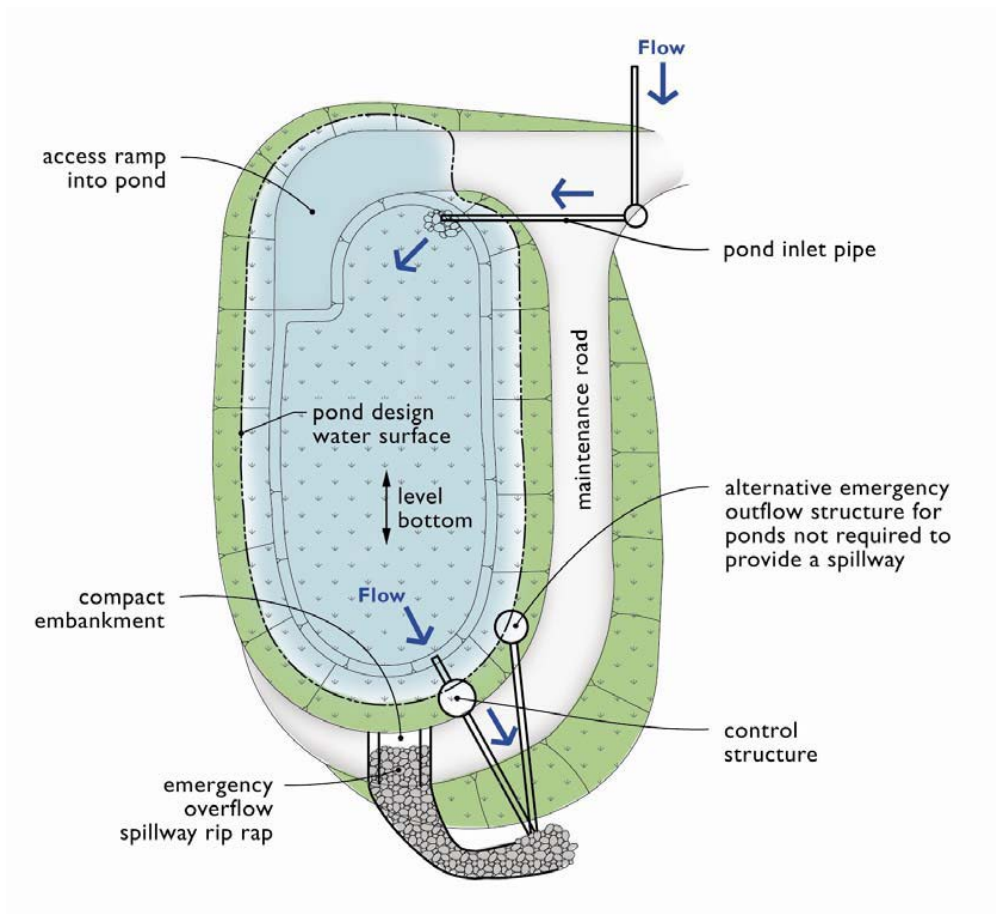

Example of a Manicured Detention Pond

Key Operations and Maintenance Considerations

- Maintenance is of primary importance if detention ponds are to continue to function well.
- Sediment should be removed when the standards in the defect table are exceeded. Sediments must be disposed in accordance with current local health department requirements and the Minimum Functional Standards for Solid Waste Handling. For additional guidance see [Book 3, Appendix 3-E](#), Recommendations for Management of Street Waste.
- Handle sediments removed during the maintenance operation in a manner consistent with [Book 3, Appendix 3-E](#), Recommendations for Management of Street Waste.
- If a shallow marsh has established, then contact Clark County Department of Environmental Services for advice.
- Maintenance of sediment forebays and attention to sediment accumulation within the pond is extremely important. Continually monitor sediment deposition in the basin. Owners, operators, and maintenance authorities should be aware that significant concentrations of metals (e.g., lead, zinc, and cadmium) as well as some organics such as pesticides, may be expected to accumulate at the bottom of these types of facilities. Regularly conduct testing sediment, especially near points of inflow, to determine the leaching potential and level of accumulation of potentially hazardous material before disposal.
- Slope areas that have become bare should be revegetated and eroded areas should be regraded prior to being revegetated.
- A common tool for cleaning detention ponds is a small bulldozer or excavator to remove built-up sediment and debris from the bottom of the pond during the dry season.

Plant Material

Table 1: Stormwater Tract "Low Grow" Seed Mix* for Detention Pond

Stormwater Tract "Low Grow" Seed Mix*		
<u>Botanical Name</u>	<u>Common Name</u>	<u>% By Weight</u>
<i>Festuca arundinacea</i> var.	Dwarf tall fescue	40%
<i>Lolium perenne</i> var. <i>barclay</i>	Dwarf perennial rye** 'Barclay'	30%
<i>Festuca rubra</i>	Red fescue	25%
<i>Agrostis tenius</i>	Colonial bentgrass	5%
Selected plants shall not include any plants from the State of Washington Noxious Weed List. Refer to clark.wa.gov/weed/ for a current list of noxious weeds.		
*Adapted from Ecology 2012, v.III, Ch 3.2.		
** If wildflowers are used and sowing is done before Labor Day, the amount of dwarf perennial rye can be reduced proportionately to the amount of wildflower seed used.		

Detention Pond			
Drainage System Feature	Potential Defect	Conditions When Maintenance Is Needed	Minimum Performance Standard
Note: table spans multiple pages.			
General	Trash and Debris	<p>Any trash and debris which exceed 1 cubic foot per 1,000 square feet. In general, there should be no visual evidence of dumping.</p> <p>If less than threshold all trash and debris will be removed as part of next scheduled maintenance.</p>	Site is free of trash and debris.
	Poisonous Plants and Noxious Weeds	<p>Any poisonous plants or nuisance vegetation which may constitute a hazard to maintenance personnel or the public.</p> <p>Any evidence of noxious weeds as defined by State or local regulations.</p> <p>(Coordinate with Clark County Environmental Services Department, Vegetation Management Program.)</p>	<p>No danger of poisonous vegetation where maintenance personnel or the public might normally be.</p> <p>Eradication of Class A weeds as required by State law. Control of Class B weeds designated by Clark County Weed Board. Control of other listed weeds as directed by local policies.</p> <p>Apply requirements of adopted IPM policy for the use of herbicides.</p>
	Vegetation Growth and Hazard Trees	<p>Vegetation growth does not allow maintenance access or interferes with maintenance activity (i.e., slope mowing, silt removal, vacuuming, or equipment movements). If trees are not interfering with access or maintenance, do not remove.</p> <p>Dead, diseased, or dying trees are identified.</p> <p>(Use a certified Arborist to determine health of tree or removal requirements.)</p>	<p>Vegetation do not hinder maintenance activities. Harvested vegetation should be recycled into mulch or other beneficial uses (e.g., alders for firewood).</p> <p>Remove hazard trees.</p>
	Contaminants and Pollution	Any evidence of oil, gasoline, contaminants or other pollutants. (Coordinate removal/cleanup with local water quality response agency.)	No contaminants or pollutants present.
	Rodent Holes	Any evidence of rodent holes if facility is acting as a dam or berm, or any evidence of water piping through dam or berm via rodent holes.	Rodents destroyed and dam or berm repaired. (Coordinate with Clark County Maintenance and Operations department; coordinate with Ecology Dam Safety Office if pond exceeds 10 acre-feet.)
	Beaver Dams	Dam results in change or function of the facility.	<p>Facility is returned to design function.</p> <p>(Coordinate trapping of beavers and removal of dams with appropriate permitting agencies.)</p>

Stormwater Treatment, Flow Control, and Conveyance Facility Components

Detention Pond			
Drainage System Feature	Potential Defect	Conditions When Maintenance Is Needed	Minimum Performance Standard
Note: table spans multiple pages.			
	Insects	When insects such as wasps and hornets interfere with maintenance activities.	Insects destroyed or removed from site. Apply insecticides in compliance with adopted Clark County Operations and Maintenance policies.
Side Slopes of Pond	Erosion	Eroded damage over 2 inches deep where cause of damage is still present or where there is potential for continued erosion. Any erosion observed on a compacted berm embankment.	Slopes have been stabilized using appropriate erosion control measure(s); e.g., rock reinforcement, planting of grass, compaction. If erosion is occurring on compacted berms a licensed civil engineer should be consulted to resolve source of erosion.
Storage Area	Sediment	Accumulated sediment that exceeds 10% of the designed pond depth unless otherwise specified or affects inletting or outletting condition of the facility.	Sediment cleaned out to designed pond shape and depth; pond reseeded if necessary to control erosion.
	Liner (If Applicable)	Liner is visible and has more than three 1/4-inch holes in it.	Liner repaired or replaced. Liner is fully covered.
Pond Berms (Dikes)	Settlements	Any part of berm which has settled 4 inches lower than the design elevation.	Dike is built back to the design elevation.
		If settlement is apparent, measure berm to determine amount of settlement.	
		Settling can be an indication of more severe problems with the berm or outlet works. A licensed civil engineer should be consulted to determine the source of the settlement.	
	Piping	Discernible water flow through pond berm. Ongoing erosion with potential for erosion to continue.	Piping eliminated. Erosion potential resolved.
		(Recommend a Geotechnical engineer be called in to inspect and evaluate condition and recommend repair of condition.	
Emergency Overflow/ Spillway and Berms Over 4 Feet in Height	Tree Growth	Tree growth on emergency spillways creates blockage problems and may cause failure of the berm due to uncontrolled overtopping. Tree growth on berms over 4 feet in height may lead to piping through the berm which could lead to failure of the berm.	Trees removed. If root system is small (base less than 4 inches) the root system may be left in place. Otherwise the roots should be removed and the berm restored. A licensed civil engineer should be consulted for proper berm/spillway restoration.

Detention Pond			
Drainage System Feature	Potential Defect	Conditions When Maintenance Is Needed	Minimum Performance Standard
Note: table spans multiple pages.			
	Piping	Discernible water flow through pond berm. Ongoing erosion with potential for erosion to continue. (Recommend a Geotechnical engineer be called in to inspect and evaluate condition and recommend repair of condition.)	Piping eliminated. Erosion potential resolved.
Emergency Overflow/ Spillway	Rock Missing	Only one layer of rock exists above native soil in area five square feet or larger, or any exposure of native soil at the top of flow path of spillway. (Rip-rap on inside slopes need not be replaced.)	Rocks and pad depth are restored to design standards.
	Erosion	Eroded damage over 2 inches deep where cause of damage is still present or where there is potential for continued erosion. Any erosion observed on a compacted berm embankment.	Slopes have been stabilized using appropriate erosion control measure(s); e.g., rock reinforcement, planting of grass, compaction. If erosion is occurring on compacted berms a licensed civil engineer should be consulted to resolve source of erosion.

Wetpond

A wetpond is an open basin that retains a permanent pool of water (wetpool) year round or only during the wet season. The volume of the wetpond allows sediment and other pollutants to settle out of the runoff. Wetland vegetation is typically planted within the wetpond to provide additional treatment through nutrient (i.e. nitrogen) removal. Detention quantity control can be provided with additional temporary storage volume above the permanent pool elevation.

Facility objects that are typically associated with a wetpond include:

- access road or easement
- fence, gate, and water quality sign
- detention pond
- control structure/flow restrictor
- energy dissipaters
- debris barrier (e.g. trash rack)
- conveyance stormwater pipe

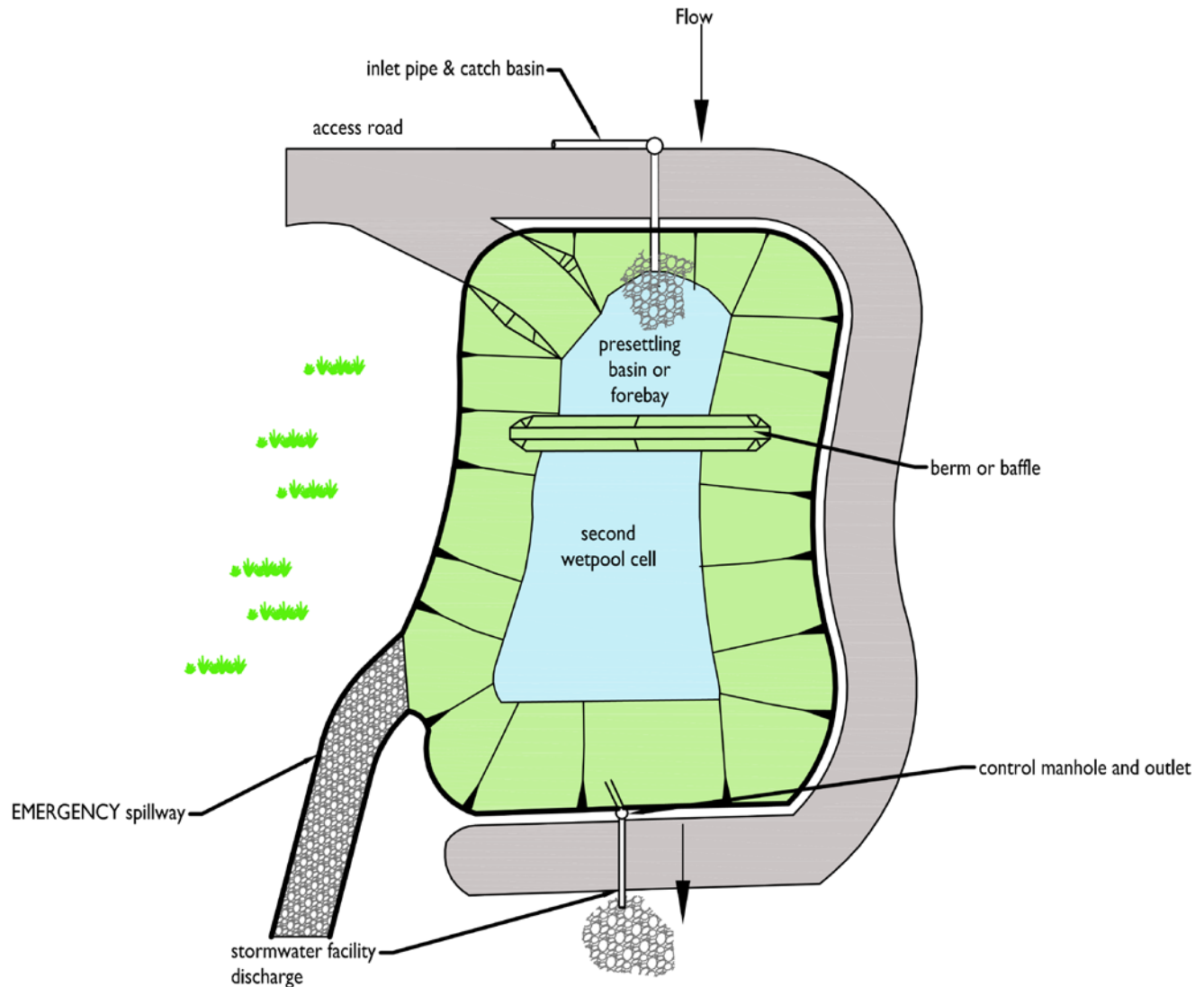

Key Operations and Maintenance Considerations

- Maintenance is of primary importance if wetponds are to continue to function well.
- Site vegetation should be trimmed as necessary to keep the pond free of leaves and to maintain the aesthetic appearance of the site. Slope areas that have become bare should be revegetated and eroded areas should be regraded prior to being revegetated.
- Sediment should be removed when the standards in the defect table are exceeded. Sediments must be disposed in accordance with current local health department requirements and the Minimum Functional Standards for Solid Waste Handling. For additional guidance see [Book 3, Appendix 3-E](#), Recommendations for Management of Street Waste.
- Any standing water removed during the maintenance operation must be properly disposed of. The preferred disposal option is discharge to a sanitary sewer at an approved location. Other disposal options include discharge back into the wetpool facility or the storm sewer system if

certain conditions are met. For additional guidance see [Book 3, Appendix 3-E](#), Recommendations for Management of Street Waste.

- If a shallow marsh has established, then contact Clark County Department of Environmental Services for advice.
- Common tools for cleaning wetponds are small bulldozers and excavators to remove built-up sediment and debris from the bottom of the pond.

Plant Material

Table 2: Emergent Wetland Plant Species Acceptable for Wetponds

Inundation to 1 Foot			Table continues on next page
<u>Botanical Name</u>	<u>Common Name</u>	<u>Notes</u>	<u>Max. Depth</u>
<i>Agrostis exarata</i> ⁽¹⁾	Spike bent grass	Prairie to coast	to 2 feet
<i>Carex stipata</i>	Sawbeak sedge	Wet ground	
<i>Eleocharis palustris</i>	Spike rush	Margins of ponds, wet meadows	to 2 feet
<i>Glyceria occidentalis</i>	Western mannagrass	Marshes, pond margins	to 2 feet
<i>Juncus tenuis</i>	Slender rush	Wet soils, wetland margins	
<i>Oenanthe sarmentosa</i>	Water parsley	Shallow water along stream and pond margins; needs saturated soils all summer	
<i>Scirpus atrocinctus</i> (formerly <i>S. cyperinus</i>)	Woolgrass	Tolerates shallow water; tall clumps	
<i>Scirpus microcarpus</i>	Small-fruited bulrush	Wet ground to 18 inches depth	18 inches
<i>Sagittaria latifolia</i>	Arrowhead		
Inundation 1 to 2 feet			
<u>Botanical Name</u>	<u>Common Name</u>	<u>Notes</u>	<u>Max. Depth</u>
<i>Agrostis exarata</i> ⁽¹⁾	Spike bent grass	Prairie to coast	
<i>Eleocharis palustris</i>	Spike rush	Margins of ponds, wet meadows	
<i>Glyceria occidentalis</i>	Western mannagrass	Marshes, pond margins	
<i>Juncus effusus</i>	Soft rush	Wet meadows, pastures, wetland margins	
<i>Scirpus microcarpus</i>	Small-fruited bulrush	Wet ground to 18 inches depth	18 inches
<i>Sparganium emmersum</i>	Bur reed	Shallow standing water, saturated soils	
Inundation 1 to 3 feet			
<u>Botanical Name</u>	<u>Common Name</u>	<u>Notes</u>	<u>Max. Depth</u>
<i>Carex obnupta</i>	Slough sedge	Wet ground or standing water	1.5 to 3 feet

<i>Beckmania syzigachne</i> ⁽¹⁾	Western sloughgrass	Wet prairie to pond margins	
<i>Scirpus acutus</i> ⁽²⁾	Hardstem bulrush	Single tall stems, not clumping	to 3 feet
<i>Scirpus validus</i> ⁽²⁾	Softstem bulrush		
Inundation Greater Than 3 feet			
<u>Botanical Name</u>	<u>Common Name</u>	<u>Notes</u>	<u>Max. Depth</u>
<i>Nuphar polysepalum</i>	Spatterdock	Deep water	3 to 7.5 feet
Acceptable Seed Mix for Wet Ponds / Wet Pools			
<u>Species</u>	<u>Common Name</u>	<u>% by Weight</u>	
<i>Scirpus acutus</i>	Hardstem bulrush	9%	
<i>Juncus effusus</i>	Soft rush	9%	
<i>Carex stipata</i>	Awl sedge	29.5%	
<i>Glyceria occidentalis</i>	Western mannagrass	25%	
<i>Eleocharis palustris</i>	Creeping spike rush	15%	
<i>Eleocharis ovata</i>	Ovoid spike rush	9%	
<i>Carex abnupta</i>	Slough sedge	3.5%	
Selected plants shall not include any plants from the State of Washington Noxious Weed List. Refer to clark.wa.gov/weed/ for a current list of noxious weeds.			
⁽¹⁾ Non-native species. Native species are preferred.			
⁽²⁾ <i>Scirpus</i> tubers must be planted shallower for establishment, and protected from foraging waterfowl until established. Emerging aerial stems should project above water surface to allow oxygen transport to the roots.			
Primary sources: Municipality of Metropolitan Seattle, Water Pollution Control Aspects of Aquatic Plants, 1990. Hortus Northwest, Wetland Plants for Western Oregon, Issue 2, 1991. Hitchcock and Cronquist, Flora of the Pacific Northwest, 1973.			

Stormwater Treatment, Flow Control, and Conveyance Facility Components

Wetpond			
Drainage System Feature	Potential Defect	Conditions When Maintenance Is Needed	Minimum Performance Standard
General	Water level	First cell is empty, doesn't hold water.	First cell lined to maintain at least 4 feet of water. Although the second cell may drain, the first cell must remain full to control turbulence of the incoming flow and reduce sediment re-suspension.
	Trash and Debris	Accumulation that exceeds 1 CF per 1000-SF of pond area.	Trash and debris removed from pond.
	Inlet/Outlet Pipe	Inlet/Outlet pipe clogged with sediment and/or debris.	Material has been removed and there is no clogging or blockage in the inlet and outlet area.
	Sediment Accumulation in Pond Bottom	Sediment accumulations in pond bottom that exceeds the depth of sediment zone plus 6-inches, usually in the first cell.	Sediment level in pond bottom is within the depth of specified sediment zone.
	Oil Sheen on Water	Prevalent and visible oil sheen.	Oil not present on pond surface. Oil has been removed from water using oil-absorbent pads or Vactor® truck. Source of oil located and corrected. If chronic low levels of oil persist, plant wetland plants such as <i>Juncus effusus</i> (soft rush) which can uptake small concentrations of oil.
	Erosion	Erosion of the pond's side slopes and/or scouring of the pond bottom, which exceeds 6-inches, or where continued erosion is prevalent.	Slopes stabilized using proper erosion control measures and repair methods.
	Settlement of Pond Dike/Berm	Any part of these components that has settled 4-inches or lower than the design elevation, or inspector determines dike/berm is unsound.	Dike/berm is repaired to design specifications.
	Internal Berm	Berm dividing cells should be level.	Berm surface is leveled so that water flows evenly over entire length of berm.
	Overflow Spillway	Rock is missing and soil is exposed at top of spillway or outside slope.	Rocks replaced to design specifications.

Filter Strip

A filter strip is a linear strip of grass that removes sediment and oils from stormwater by filtering it. Stormwater is treated as it runs across the filter. Usually, filter strips are placed along the edge of linear paved areas such as parking lots and roads. Where designed filter strips are installed, road shoulders should only be graded to maintain level flow off the road.

Facility objects that are often associated with a filter strip include:

- access road or easement
- fence, gate, and water quality sign
- energy dissipaters (flow spreaders)

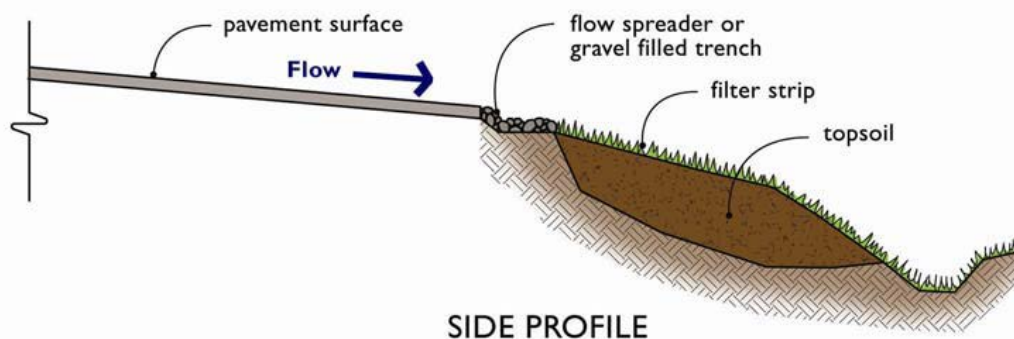
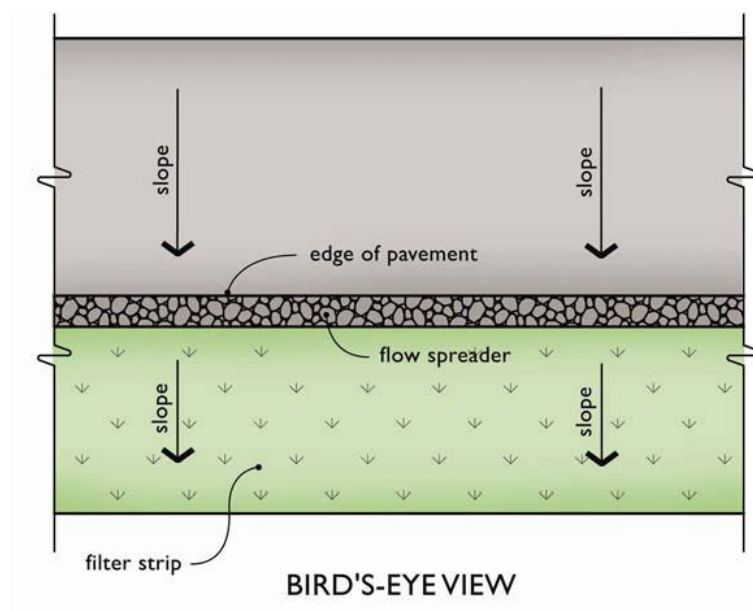

Key Operations and Maintenance Considerations

- For filtration to be effective, the filter strip area must remain covered with well-established vegetation. Site uses should protect vegetation and avoid compaction.
- Inspect the filter strip frequently, especially after intense rainfall events and runoff events of long duration. Small breaks in the sod and small erosion channels quickly become large problems.
- Inspect flow spreader area for clogging and remove built-up sediment.
- Minimize the development of erosion channels within the filter. Even small channels may allow much of the runoff from the field to bypass the filter. These areas should be repaired and reseeded immediately to help ensure proper flow of runoff through the filter.
- Reseed or interseed bare areas of the filter. Since it may be difficult to re-establish vegetation in an established filter strip, the use of mulch or sod can help to reduce some problems.
- Mow and remove cuttings as required to maintain moderate vegetation height. Mowing two to three times per year may be necessary. The vegetation should not be mowed closer than 6 inches. More frequent mowing may be needed to prevent thatch buildup and smothering of vegetation. To avoid destruction of wildlife nesting areas, delay mowing until after mid-July. Fall mowing of the filter no closer than 6 inches will provide adequate winter habitat for wildlife.
- Control trees, brush and noxious weeds in the filter using either mechanical means or approved IPM practices.
- The most common tools for maintenance of filter strips are mowers and hand tools to remove built up debris at the edge of the filter strip and restore evenly distributed flow across the strip.

Filter Strip			
Drainage System Feature	Potential Defect	Conditions When Maintenance Is Needed	Minimum Performance Standard
General	Sediment Accumulation on Grass	Sediment depth exceeds 2 inches.	Grass is free of accumulated sediment. Slope is even and water flows pass evenly through strip.
	Vegetation	Grass becomes excessively tall (greater than 10-inches); nuisance weeds and other vegetation starts to take over.	Vegetation is mowed to less than 3"-4" height. Nuisance vegetation has been removed such that flow is not impeded.
	Trash and Debris Accumulation	Trash and debris accumulated on the filter strip.	Filter strip is free of trash and debris.
	Erosion/Scouring	Eroded or scoured areas due to flow channelization, or higher flows.	Eroded/scoured areas have been repaired and facility filters stormwater per design function. (Ruts or bare areas less than 12 inches wide may be repaired filling damaged portion with crushed gravel; grass will creep in over the rock in time. For large bare areas [generally >12" wide], the filter strip should be re-graded and re-seeded. For smaller bare areas, over seed when bare spots are evident.)
	Flow spreader	Flow spreader uneven or clogged so that flows are not uniformly distributed through entire filter width.	Spreader is level and clean so that flows are spread evenly over entire filter width.

Compost-Amended Vegetated Filter Strip (CAVFS)

The CAVFS is a vegetated filter strip that adds soil amendments to the roadside embankment. The soil amendments improve infiltration characteristics, increase surface roughness, and improve plant sustainability. Once permanent vegetation is established, the advantages of the CAVFS are greater retention and infiltration capacity, improved removal of soluble cationic contaminants through sorption, improved overall vegetative health, and a reduction of invasive weeds.

Compost, as with sand filters or other filter mediums, can become plugged with fines and sediment, and may require removal and replacement. Including vegetation with compost helps prevent the medium from becoming plugged with sediment by breaking up the sediment and creating root pathways for stormwater to penetrate into the compost. It is expected that soil amendments will have a removal and replacement cycle; however, this time frame has not yet been established.

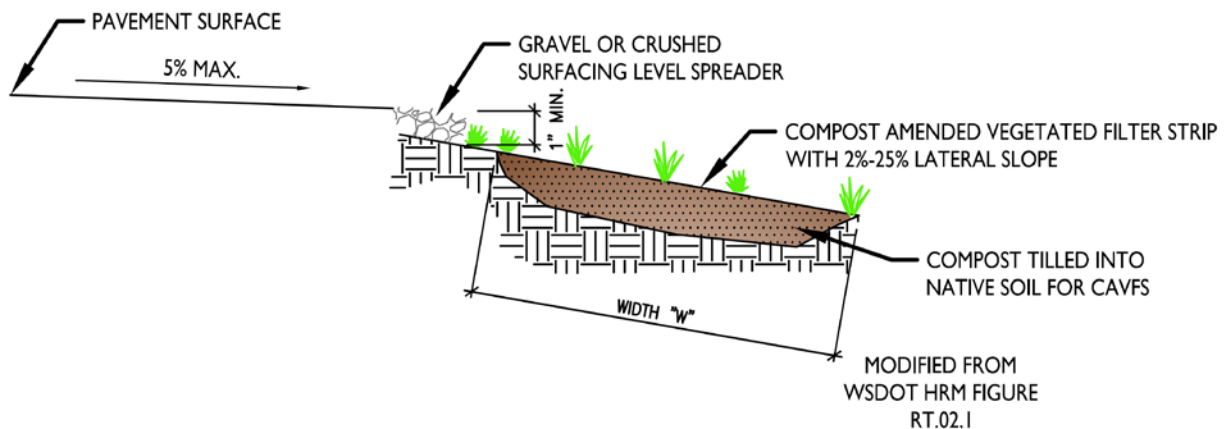

Source: modified from Washington Department of Transportation *Highway Runoff Manual* Figure RT.02.1

Key Operations and Maintenance Considerations

- Avoid compaction of the amended soils - do not run heavy equipment on the filter strip, and limit foot traffic to times when the soils are not wet/saturated.
- For filtration to be effective, the CAVFS must remain covered with well-established vegetation.
- Inspect the filter strip frequently, especially after intense rainfall events and runoff events of long duration. Small breaks in the sod and small erosion channels quickly become large problems.
- Inspect flow spreader area for clogging and remove built-up sediment.
- Minimize the development of erosion channels within the filter. Even small channels may allow much of the runoff from the field to bypass the filter. These areas should be repaired and reseeded immediately to help ensure proper flow of runoff through the filter.
- Reseed or interseed bare areas of the filter.

- Mow and remove cuttings as required to maintain moderate vegetation height. Mowing two to three times per year may be necessary. The vegetation should not be mowed closer than 6 inches. More frequent mowing may be needed to prevent thatch buildup and smothering of vegetation. To avoid destruction of wildlife nesting areas, delay mowing until after mid-July. Fall mowing no closer than 6 inches will provide adequate winter habitat for wildlife.
- Control trees, brush and noxious weeds in the filter using either mechanical means or approved IPM practices. Use of herbicides may be prohibited in stormwater management or environmentally sensitive areas.
- The most common tools for maintenance of compost-amended filter strips are mowers and hand tools to remove built up debris at the edge of the filter strip to restore evenly distributed flow across the strip.

Compost-Amended Vegetated Filter Strip (CAVFS)

Drainage System Feature	Potential Defect	Conditions When Maintenance is Needed	Minimum Performance Standards
General	Sediment accumulation on grass	Sediment depth exceeds 2 inches.	Grass is free of accumulated sediment. Slope is even and water flows pass evenly through strip.
	Vegetation	Grass becomes excessively tall (greater than 10 inches); nuisance weeds and other vegetation start to take over.	Vegetation is mowed to less 3"-4" height. Nuisance vegetation has been removed such that flow is not impeded.
	Trash and debris	Trash and debris have accumulated on the vegetated filter strip.	Remove trash and debris from filter.
	Erosion/scouring	Areas have eroded or scoured due to flow channelization or high flows.	Eroded/scoured areas have been repaired and facility filters stormwater per design function. (Ruts or bare areas less than 12 inches wide may be repaired filling damaged portion with crushed gravel; grass will creep in over the rock in time. For large bare areas [generally >12" wide], the filter strip should be re-graded and re-seeded. For smaller bare areas, over seed when bare spots are evident.)
Flow spreader	Flow spreader is uneven or clogged so that flows are not uniformly distributed over entire filter width.	Spreader is level and clean so that flows are spread evenly over entire filter width.	

Media Filter Drain (MFD)

The MFD, previously referred to as the ecology embankment, is a linear flow-through stormwater runoff treatment device that can be sited along highway side slopes (conventional design) and medians (dual media filter drains), borrow ditches, or other linear depressions. The media filter drain can be used where available right of way is limited, sheet flow from the highway surface is feasible, and lateral gradients are generally less than 25% (4H:1V).

Facility objects that are often associated with a MFD include:

- access road or easement
- fence, gate, and water quality sign

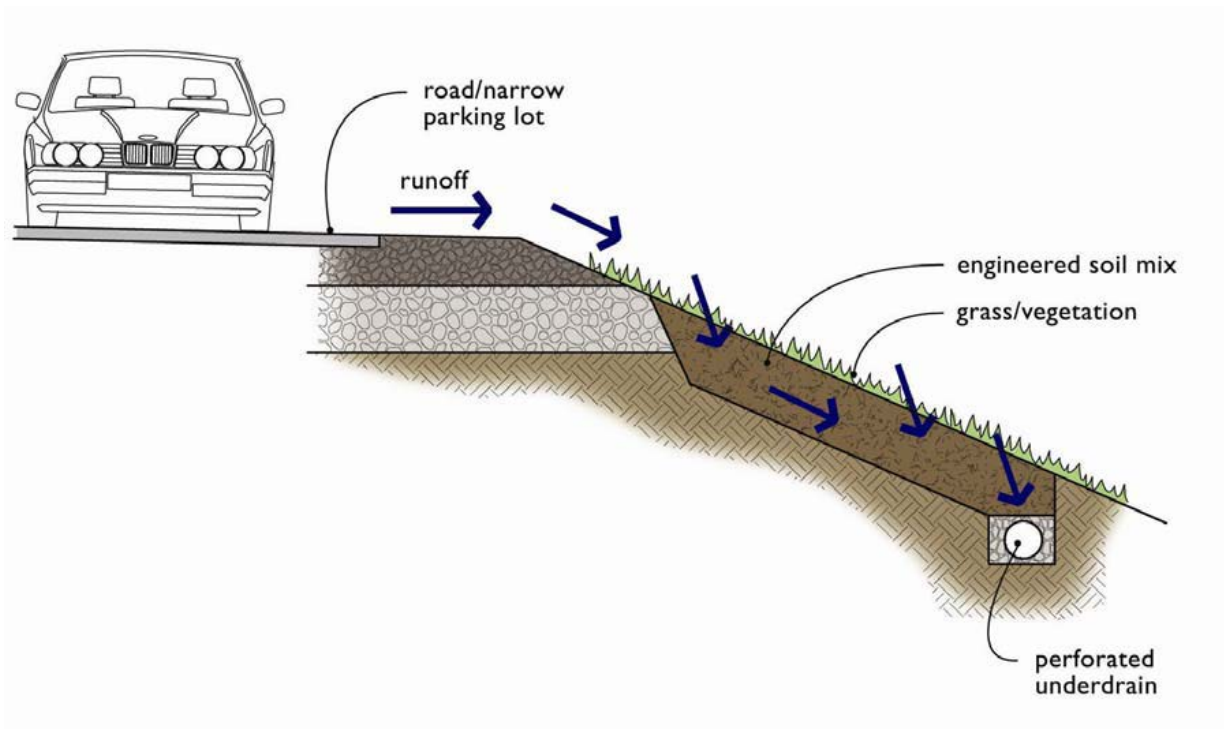

Key Operations and Maintenance Considerations

- Maintenance will consist of routine roadside management.
- While herbicides must not be applied directly over the media filter drain, it may be necessary to periodically control noxious weeds with herbicides in areas around the media filter drain as part of a roadside management program. The use of pesticides may be prohibited if the media filter drain is in a critical aquifer recharge area for drinking water supplies. Check the design drawings or drainage report.
- Avoid compaction of the soil mix - do not run heavy equipment on the MFD, and limit foot traffic to times when the soils are not wet/saturated.

- Areas of the media filter drain that show signs of physical damage may be replaced by local maintenance staff in consultation with a qualified hydraulics/water quality professional.
- The most common tools for maintenance of media filter drains are mowers and hand tools to remove built up debris at the edge of the filter drain to restore evenly distributed flow across the media.

Media Filter Drain (MFD)			
Drainage System Feature	Potential Defect	Conditions When Maintenance Is Needed	Minimum Performance Standard
General	Sediment accumulation on grass filter strip	Sediment depth exceeds 2 inches or creates uneven grading that interferes with sheet flow.	Grass is free of accumulated sediment. Slope is even and water flows pass evenly through strip. There should be no areas of standing water once inflow has ceased.
	No-vegetation zone/flow spreader	Flow spreader is uneven or clogged so that flows are not uniformly distributed over entire embankment width.	Spreader is level and clean so that flows are spread evenly over entire embankment width.
	Poor vegetation coverage	Grass is sparse or bare, or eroded patches are observed in more than 10% of the grass strip surface area.	Grass coverage is good and facility meets design function. (Determine why grass growth is poor and correct the offending condition. Replant with plugs of grass from the upper slope or reseed into loosened, fertile soil or compost.)
	Vegetation	Grass becomes excessively tall (greater than 10 inches); nuisance weeds and other vegetation start to take over.	Vegetation is mowed to less than 6" height. Nuisance vegetation has been removed such that flow is not impeded.
	Water not draining properly through the media filter drain	Water is seen on the surface of the media filter drain mix from storms that are less than a 6-month, 24-hour precipitation event. Maintenance also needed on a 10-year cycle and during a preservation project.	Media filter drain media has been replaced, if necessary, and proper drainage per design function has been restored.
	Excessive shading	Grass growth is poor because sunlight does not reach embankment.	Overhanging limbs and brushy vegetation on adjacent slopes has been trimmed back (extent based on acceptable aesthetics and maintained plant health) to allow adequate sunlight to reach embankment grass.
	Trash and debris	Trash and debris have accumulated on embankment.	Embankment is free of trash and debris.
	Flooding of Media filter drain	When media filter drain is inundated by flood water.	Media filter drain material has been evaluated for acceptable infiltration rate and replaced as necessary if media does not meet long-term infiltration rate standards.

Basic Biofiltration Swale

A biofiltration swale uses grass or other dense vegetation to filter sediment and oily materials out of stormwater. Usually they look like flat-bottomed channels with grass growing in them. Biofiltration uses vegetation in conjunction with slow and shallow-depth flow for runoff treatment. As runoff passes through the vegetation, pollutants are removed through the combined effects of filtration, infiltration, and settling. These effects are aided by the reduction of the velocity of stormwater as it passes through the swale.

Facility objects that are often associated with a basic biofiltration swale include:

- access road or easement
- fence, gate, and water quality sign
- energy dissipaters
- catch basins/field inlets
- drywell
- infiltration trench
- sediment trap

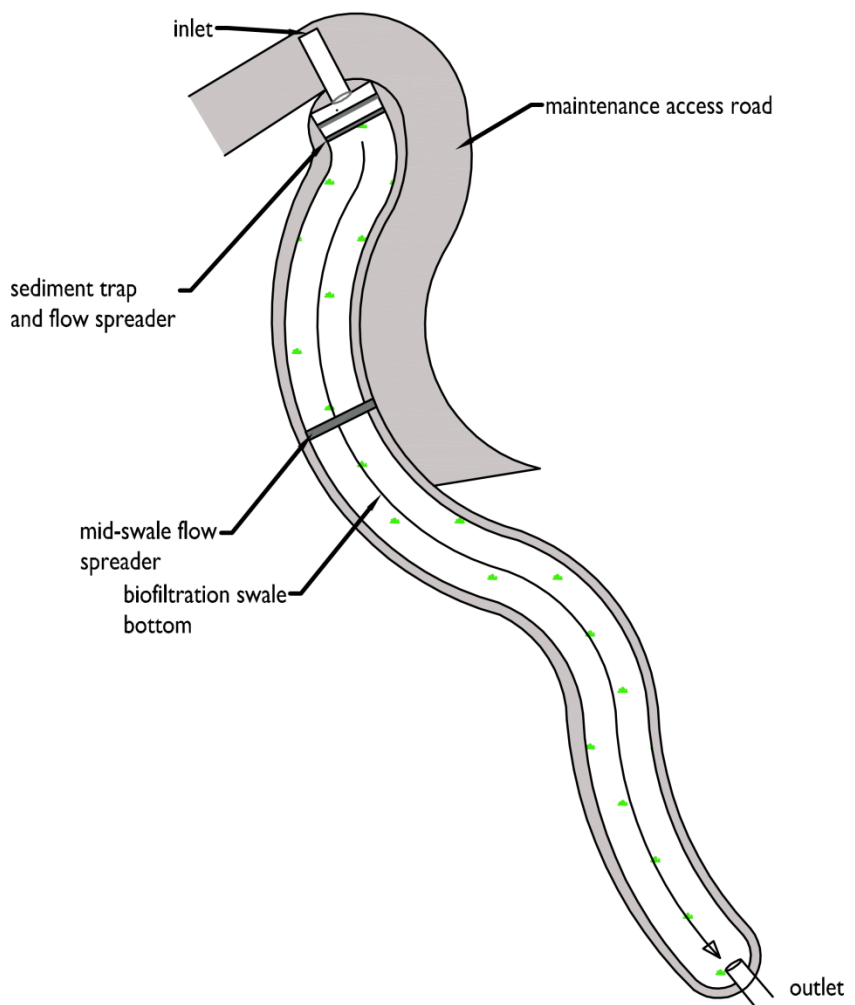

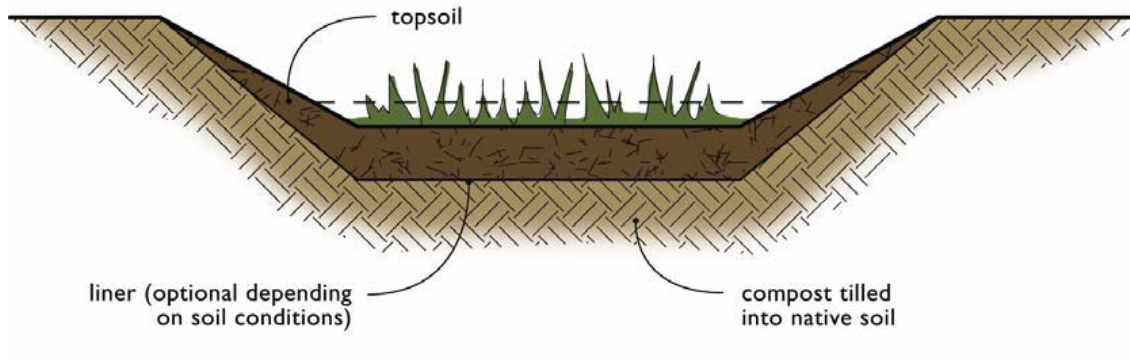

Example Typical Biofiltration Swale



Example Typical Biofiltration Swale

Key Operations and Maintenance Considerations

- Inspect swales at least once every 6 months, preferably during storm events, and also after storm events of > 0.5 inch rainfall/ 24 hours. Maintain adequate grass growth and eliminate bare spots.
- Mow grasses, if needed for good growth (typically maintain at 4 to 9 inches).
- Remove leaves, litter, and oily materials, from swale, inlets, and flow spreaders as needed.
- Prevent scouring and soil erosion. Regrade and reseed the swale, as necessary.
- Maintain access to the inlet, outlet, and for mowing.
- If a swale is equipped with underdrains, avoid vehicular traffic on the swale bottom (other than grass mowing equipment) to prevent damage to the drainpipes.
- The most common tools for maintenance of biofiltration swales are mowers and hand tools to remove built up sediment and debris in the swale and to redistribute media displaced.

Plant Material

Table 3: Plant Mixes for Biofiltration Swale Treatment Area

Bioswale Dry Soil Conditions		
<u>Botanical Name</u>	<u>Common Name</u>	<u>% By Weight</u>
<i>Elymus glaucus</i>	blue wildrye	50.00%
<i>Agrostis exerata</i>	spike bentgrass	10.00%
<i>Bromus carinatus</i>	California brome	10.00%
<i>Festuca idahoensis</i>	Idaho fescue	30.00%
Bioswale Wet or Dry Soil Conditions		
<u>Botanical Name</u>	<u>Common Name</u>	<u>%By Weight</u>
<i>Elymus glaucus</i>	blue wildrye	60.00%
<i>Hordeum brachyantherum</i>	meadow barley	30.00%
<i>Bromus carinatus</i>	California brome	10.00%
Bioswale Wet Soil Conditions		
<u>Botanical Name</u>	<u>Common Name</u>	<u>% By Weight</u>
<i>Agrostis exerata</i>	spike bentgrass	0.50%
<i>Deschampsia cespitosa</i>	tufted hairgrass	2.50%
<i>Glyceria occidentalis</i>	western mannagrass	25.00%
<i>Juncus effusus</i>	soft rush	8.00%
<i>Beckmannia syzigachne</i>	slough grass	4.00%
<i>Alopecurus geniculatus</i>	water foxtail	15.00%
<i>Hordeum brachyantherum</i>	meadow barley	45.00%
Selected plants shall not include any plants from the State of Washington Noxious Weed List. Refer to clark.wa.gov/weed/ for a current list of noxious weeds.		

Table 4: Groundcovers and Grasses Suitable for Upper Side Slopes of a Swale

Groundcovers	
<u>Botanical Name</u>	<u>Common Name</u>
<i>Arctostaphylos uva-ursi</i>	kinnikinnick
<i>Fragaria chiloensis</i>	strawberry
<i>Lupinus latifolius</i>	broadleaf lupine
Grasses (drought-tolerant, minimum mowing)	
<u>Botanical Name</u>	<u>Common Name</u>
<i>Festuca spp. (e.g., Many Mustang, Silverado)</i>	dwarf tall fescues
<i>Festuca ovina duriuscula (e.g., Reliant, Aurora)</i>	hard fescue
<i>Festuca amethystine</i>	tufted fescue
<i>Buchloe dactyloides</i>	buffalo grass
<i>Festuca rubra</i>	red fescue
<i>Festuca arundinacea</i>	tall fescue grass
<i>Helictotrichon sempervirens</i>	blue oatgrass
Selected plants shall not include any plants from the State of Washington Noxious Weed List. Refer to clark.wa.gov/weed/ for a current list of noxious weeds.	

Basic Biofiltration Swale			
Drainage System Feature	Potential Defect	Conditions When Maintenance Is Needed	Minimum Performance Standard
Note: table spans multiple pages.			
General	Sediment Accumulation on Grass	Sediment depth exceeds 2 inches.	Grass treatment area of the swale is free of accumulated sediment deposits. Swale bottom is level from side to side and drains freely toward outlet. There should be no areas of standing water once inflow has ceased.
	Standing Water	When water stands in the swale between storms and does not drain freely.	Water drains from swale per design standards after a storm. (Any of the following may apply: remove sediment or trash blockages, improve grade from head to foot of swale, remove clogged check dams, add underdrains or convert to a wet biofiltration swale.)
	Flow spreader	Flow spreader uneven or clogged so that flows are not uniformly distributed through entire swale width.	Spreader is level and clean so that flows are spread evenly over entire filter width.

Stormwater Treatment, Flow Control, and Conveyance Facility Components

Basic Biofiltration Swale			
Drainage System Feature	Potential Defect	Conditions When Maintenance Is Needed	Minimum Performance Standard
Note: table spans multiple pages.			
	Constant Baseflow	When small quantities of water continually flow through the swale, even when it has been dry for weeks, and an eroded, muddy channel has formed in the swale bottom.	A low-flow pea-gravel drain the length of the swale has been added or a by-pass created for the baseflow around the swale.
	Poor Vegetation Coverage	When grass is sparse or bare or eroded patches occur in more than 10% of the swale bottom.	Grass coverage has been restored to good condition and facility meets design function.
	Vegetation	When the grass becomes excessively tall (greater than 10 inches); when nuisance weeds and other vegetation starts to take over.	Vegetation is mowed to less 3"-4" height. Nuisance vegetation has been removed such that flow is not impeded. Grass clippings removed from swale.
	Excessive Shading	Grass growth is poor because sunlight does not reach swale.	Overhanging limbs and brushy vegetation on adjacent slopes has been trimmed back to (extent based on acceptable aesthetics and maintained plant health) to allow adequate sunlight to reach grass in swale.
	Inlet/Outlet	Inlet/outlet areas clogged with sediment and/or debris.	Material has been removed and there is no clogging or blockage in the inlet and outlet area.
	Trash and Debris Accumulation	Trash and debris accumulated in the bio-swale.	Remove trash and debris from bioswale.
	Erosion/Scouring	Eroded or scoured swale bottom due to flow channelization, or higher flows.	Eroded/scoured areas have been repaired and facility filters stormwater per design function. (Ruts or bare areas less than 12 inches wide may be repaired filling damaged portion with crushed gravel; grass will creep in over the rock in time. For large bare areas [generally >12" wide], the swale should be re-graded and re-seeded. For smaller bare areas, over-seed when bare spots are evident, or take plugs of grass from the upper slope and plant in the swale bottom at 8-inch intervals.)

Wet Biofiltration Swale

A wet biofiltration swale is a variation of a basic biofiltration swale for use where the centerline slope is slight, groundwater tables are high, or a continuous low base flow is likely to result in wet soil conditions for long periods of time. Where continuously wet soil conditions exceeds about 2 weeks, typical grasses will die. Thus, vegetation specifically adapted to wet soil conditions is needed. Different vegetation, in turn, requires modification of several of the design and maintenance requirements from the basic biofiltration swale.

Facility objects that are often associated with a wet biofiltration swale include:

- access road or easement
- fence, gate, and water quality sign
- energy dissipaters (flow spreaders)
- debris barrier (e.g. trash rack)
- catch basins/field inlets

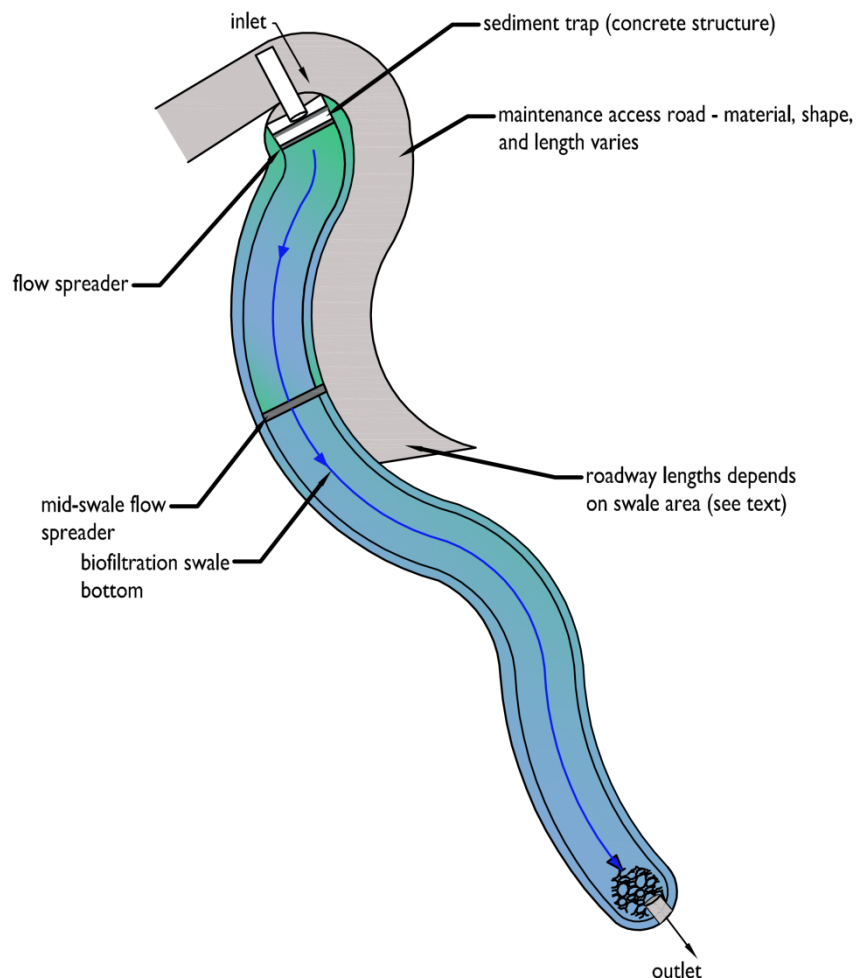

Key Operations and Maintenance Considerations

- Same as for basic biofiltration swales except mowing of wetland vegetation is not required. However, harvesting of very dense vegetation may be desirable in the fall after plant die-back to prevent the sloughing of excess organic material into receiving waters. Many native *Juncus* species remain green throughout the winter; therefore, fall harvesting of *Juncus* species is not recommended.
- The most common tools for maintenance of wet biofiltration swales are hand tools to remove built up sediment and debris in the swale and to redistribute media displaced.

Plant Material

Table 5: Acceptable Plants for Wet Biofiltration Swale

Wet Biofiltration Swale Treatment Area		
<u>Botanical Name</u>	<u>Common Name</u>	<u>O.C. Spacing</u>
<i>Alopecurus aequalis</i>	Shortawn foxtail	seed
<i>Alopecurus geniculatus</i>	Water foxtail	seed
<i>Eleocharis ovata</i>	Spike rush	4 inches or seed
<i>Carex stipata</i>	Sawbeak sedge	6 inches
<i>Carex obnupta</i>	Slough Sedge	6 inches
<i>Glyceria occidentalis</i>	Western mannagrass	seed
<i>Holcus mollis</i>	Velvetgrass	seed
<i>Juncus tenuis</i>	Slender rush	6 inches
<i>Oenanthe sarmentosa</i>	Water parsley*	6 inches
<i>Scirpus acutus</i>	Hardstem bulrush	6 inches
<i>Scirpus microcarpus</i>	Small-fruited bulrush	12 inches
<i>Juncus effusus</i>	Soft rush	18 inches
<i>Juncus oxymeris</i>	Pointed rush	12 inches
<i>Juncus ensifolius</i>	Dagger leaf rush	12 inches

Selected plants shall not include any plants from the State of Washington Noxious Weed List. Refer to clark.wa.gov/weed/ for a current list of noxious weeds.

*Good choices for swales with significant periods of flow, such as those downstream of a detention facility.

Note: Cattail (*Typha latifolia*) is not appropriate for most wet swales because of its very dense and clumping growth habit which prevents water from filtering through the clump.

Wet Biofiltration Swale			
Drainage System Feature	Potential Defect	Conditions When Maintenance Is Needed	Minimum Performance Standard
General	Sediment Accumulation	Sediment depth exceeds 2 inches in 10% of the swale treatment area.	Treatment area is free of accumulated sediment deposits.
	Water Depth	Water not retained to a depth of about 4 inches during the wet season.	Outlet berm has been built up or repaired so that water is retained in the wet swale.
	Wetland Vegetation	Vegetation becomes sparse and does not provide adequate filtration, OR vegetation is crowded out by very dense clumps of cattail, which do not allow water to flow through the clumps.	Vegetation healthy with good but not excessive coverage; facility meets design function. (Determine cause of lack of vigor of vegetation and correct. Replant as needed. For excessive cattail growth, cut cattail shoots back and compost off-site. Note: normally wetland vegetation does not need to be harvested unless die-back is causing oxygen depletion in downstream waters.)
	Inlet/Outlet	Inlet/outlet area clogged with sediment and/or debris.	Clogging or blockage in the inlet and outlet areas has been removed. Water flows per design function.
	Trash and Debris Accumulation	Any trash and debris which exceed 1 cubic foot per 1,000 square feet. In general, there should be no visual evidence of dumping. If less than threshold all trash and debris will be removed as part of next scheduled maintenance.	Wet swale is free of trash and debris.
	Erosion/Scouring	Swale has eroded or scoured due to flow channelization, or higher flows.	Eroded/scoured areas have been repaired and facility treats stormwater per design function. (Check design flows to assure swale is large enough to handle flows. By-pass excess flows or enlarge swale. Replant eroded areas with fibrous-rooted plants such as Juncus effusus (soft rush) in wet areas or snowberry (Symphoricarpos albus) in dryer areas.)

Treatment Wetland

A stormwater treatment wetland is a shallow constructed pond that is designed to treat stormwater through the biological processes associated with emergent aquatic plants. These facilities use dense wetland vegetation and settling to filter sediment and oily materials out of stormwater.

Stormwater treatment wetlands are used to capture pollutants in a managed environment so that they will not reach natural wetlands and other ecologically important habitats. Vegetation must occasionally be harvested and sediment dredged in stormwater treatment wetlands. In general, stormwater wetlands perform well to remove sediment, metals, and pollutants that bind to humic or organic acids.

Facility objects that are often associated with a treatment wetland include:

- inlet
- flow control structure
- detention pond
- access road or easement
- fence, gate, and water quality sign
- energy dissipaters (flow spreaders)
- conveyance stormwater pipe



Example Treatment Wetland

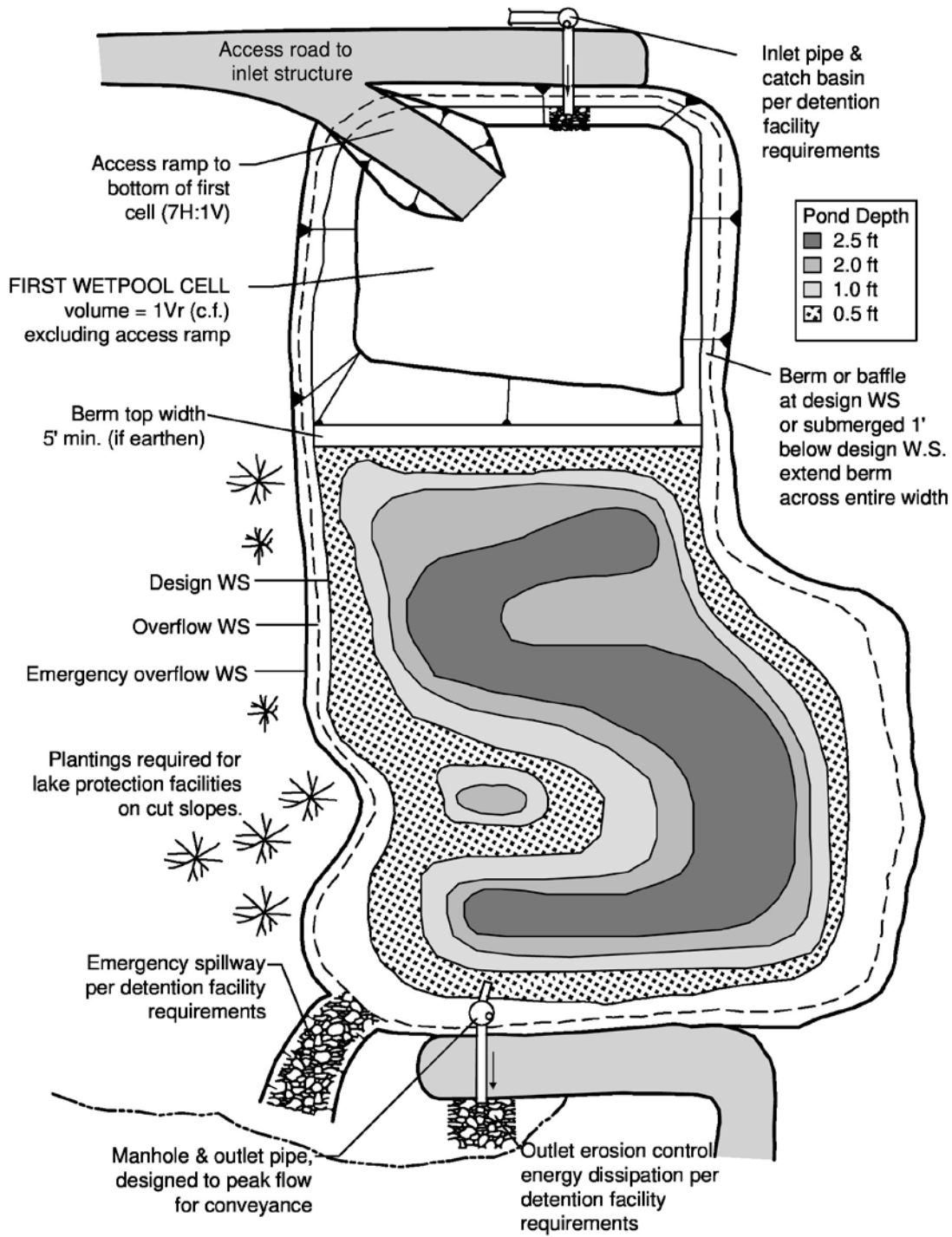

PLAN VIEW Option B
NTS

Key Operations and Maintenance Considerations

- Wetlands should be inspected at least twice per year during the first three years during both growing and non-growing seasons to observe plant species presence, abundance, and condition; bottom contours and water depths relative to plans; and sediment, outlet, and buffer conditions.
- Maintenance should be scheduled around sensitive wildlife and vegetation seasons.
- Plants may require watering, physical support, mulching, weed removal, or replanting during the first three years.
- Nuisance plant species should be removed and desirable species should be replanted.

Plant Material

Table 6: Emergent Wetland Species for Treatment Wetlands

Inundation to 1 Foot			Table continues on next page.
<u>Botanical Name</u>	<u>Common Name</u>	<u>Notes</u>	<u>Max. Depth</u>
<i>Agrostis exarata</i> ⁽¹⁾	Spike bent grass	Prairie to coast	to 2 feet
<i>Carex stipata</i>	Sawbeak sedge	Wet ground	
<i>Eleocharis palustris</i>	Spike rush	Margins of ponds, wet meadows	to 2 feet
<i>Glyceria occidentalis</i>	Western mannagrass	Marshes, pond margins	to 2 feet
<i>Juncus tenuis</i>	Slender rush	Wet soils, wetland margins	
<i>Oenanthe sarmentosa</i>	Water parsley	Shallow water along stream and pond margins; needs saturated soils all summer	
<i>Scirpus atrocinctus</i> (formerly <i>S. cyperinus</i>)	Woolgrass	Tolerates shallow water; tall clumps	
<i>Scirpus microcarpus</i>	Small-fruited bulrush	Wet ground to 18 inches depth	18 inches
<i>Sagittaria latifolia</i>	Arrowhead		
Inundation 1 to 2 feet			
<u>Botanical Name</u>	<u>Common Name</u>	<u>Notes</u>	<u>Max. Depth</u>
<i>Agrostis exarata</i> ⁽¹⁾	Spike bent grass	Prairie to coast	
<i>Eleocharis palustris</i>	Spike rush	Margins of ponds, wet meadows	
<i>Glyceria occidentalis</i>	Western mannagrass	Marshes, pond margins	
<i>Juncus effusus</i>	Soft rush	Wet meadows, pastures, wetland margins	
<i>Scirpus microcarpus</i>	Small-fruited bulrush	Wet ground to 18 inches depth	18 inches
<i>Sparganium emmersum</i>	Bur reed	Shallow standing water, saturated soils	

Inundation 1 to 3 feet			
<u>Botanical Name</u>	<u>Common Name</u>	<u>Notes</u>	<u>Max. Depth</u>
<i>Carex obnupta</i>	Slough sedge	Wet ground or standing water	1.5 to 3 feet
<i>Beckmania syzigachne</i> ⁽¹⁾	Western sloughgrass	Wet prairie to pond margins	
<i>Scirpus acutus</i> ⁽²⁾	Hardstem bulrush	Single tall stems, not clumping	to 3 feet
<i>Scirpus validus</i> ⁽²⁾	Softstem bulrush		
Inundation Greater Than 3 feet			
<u>Botanical Name</u>	<u>Common Name</u>	<u>Notes</u>	<u>Max. Depth</u>
<i>Nuphar polysepalum</i>	Spatterdock	Deep water	3 to 7.5 feet
Acceptable Seed Mix for Wet Ponds / Wet Pools			
<u>Species</u>	<u>Common Name</u>	<u>% by Weight</u>	
<i>Scirpus acutus</i>	Hardstem	9%	
	bulrush		
<i>Juncus effusus</i>	Soft rush	9%	
<i>Carex stipata</i>	Awl sedge	29.5%	
<i>Glyceria occidentalis</i>	Western	25%	
	mannagrass		
<i>Eleocharis palustris</i>	Creeping spike	15%	
	rush		
<i>Eleocharis ovata</i>	Ovoid spike rush	9%	
<i>Carex abnupta</i>	Slough sedge	3.5%	
Selected plants shall not include any plants from the State of Washington Noxious Weed List. Refer to clark.wa.gov/weed/ for a current list of noxious weeds.			
⁽¹⁾ Non-native species. Native species are preferred.			
⁽²⁾ <i>Scirpus</i> tubers must be planted shallower for establishment, and protected from foraging waterfowl until established. Emerging aerial stems should project above water surface to allow oxygen transport to the roots.			
Primary sources: Municipality of Metropolitan Seattle, Water Pollution Control Aspects of Aquatic Plants, 1990. Hortus Northwest, Wetland Plants for Western Oregon, Issue 2, 1991. Hitchcock and Cronquist, Flora of the Pacific Northwest, 1973.			

Treatment Wetland			
Drainage System Feature	Potential Defect	Conditions When Maintenance Is Needed	Minimum Performance Standard
General	Water Depth	Water not retained to a depth of about 18 inches during the wet season.	Water is retained in the wet swale, outlet repaired as necessary.
	Wetland Vegetation	Vegetation becomes sparse and does not provide adequate filtration.	Vegetation coverage restored and healthy, and provides filtration per design function.
		Nuisance plant species becomes abundant.	Nuisance plant species have been removed and desirable species should be planted in their place.
	Trash and Debris Accumulation	Any trash and debris which exceed 1 cubic foot per 1,000 square feet. In general, there should be no visible evidence of dumping. If less than threshold all trash and debris will be removed as part of next scheduled maintenance.	Wetland area is free of trash and debris.
	Oil Sheen on Water	Prevalent and visible oil sheen.	Oil not present on pond surface. Oil has been removed from water using oil-absorbent pads or Vactor® truck. Source of oil located and corrected. If chronic low levels of oil persist, plant wetland plants such as <i>Juncus effusus</i> (soft rush) which can uptake small concentrations of oil.
	Erosion	Erosion of the pond's side slopes and/or scouring of the pond bottom, which exceeds 6-inches, or where continued erosion is prevalent.	Slopes stabilized using proper erosion control measures and repair methods.
	Settlement of Pond Dike/Berm	Any part of these components has settled 4-inches or lower than the design elevation, or inspector determines dike/berm is unsound.	Dike/berm is repaired to design specifications.
	Overflow Spillway	Rock is missing and soil is exposed at top of spillway or outside slope.	Rocks replaced to design specifications.

Closed Detention System (Tank/Vault)

A closed detention system functions similarly to a detention pond with the temporary storage volume provided by an underground structure to regulate the storm discharge rate from the site. The structure is typically constructed of large diameter pipe (48 inch diameter or greater) or a concrete box (vault). These systems are typically utilized for sites that do not have space available for an above-ground system and are more commonly associated with commercial sites.

Facility objects that are typically associated with a closed detention system include:

- access road or easement
- control structure/flow restrictor
- conveyance stormwater pipe

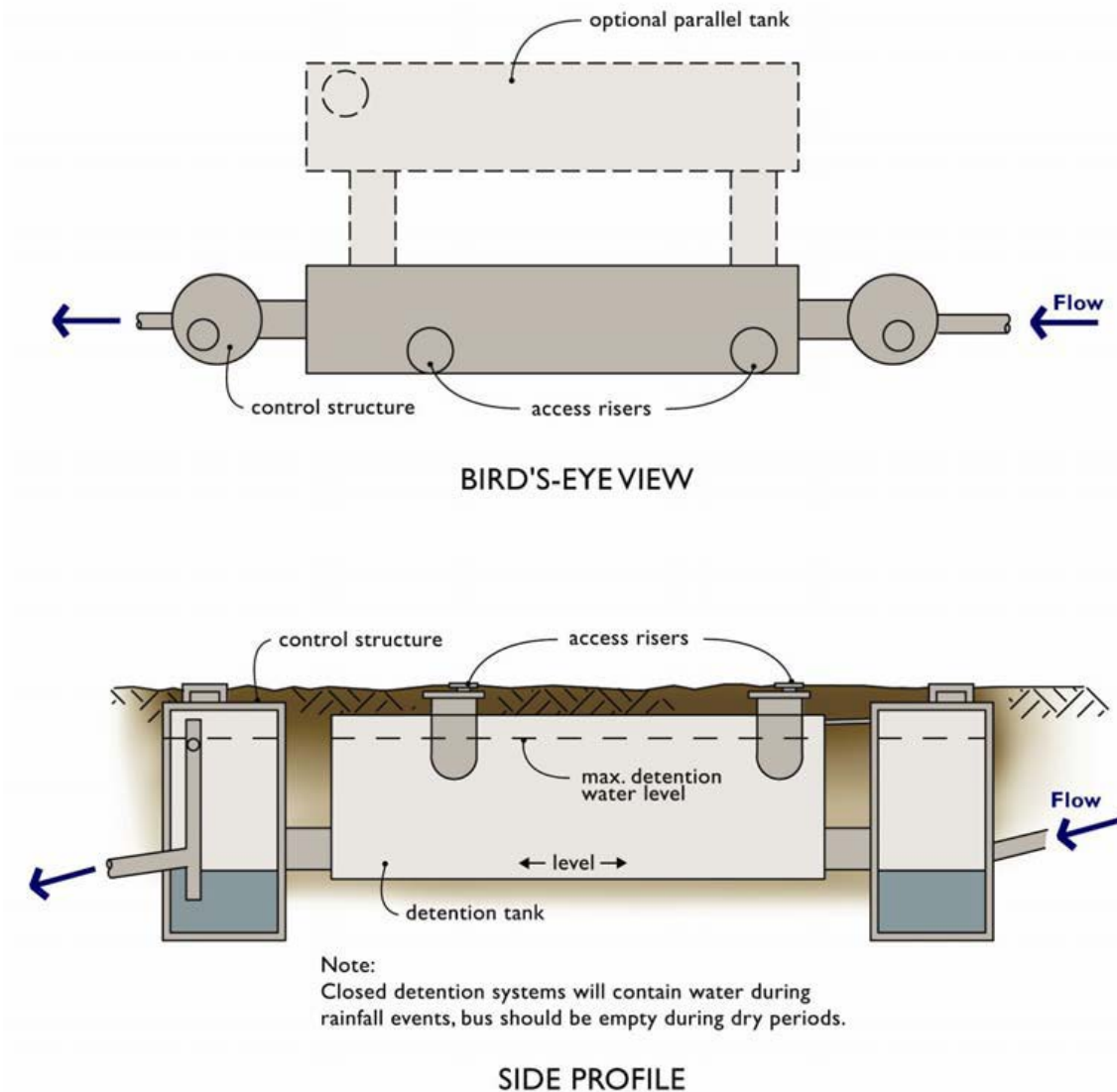

Key Operations and Maintenance Considerations

- The most common tool for cleaning closed detention systems is a truck with a tank and vacuum hose (Vactor® truck) to remove sediment and debris from the vault/tank.
- A closed detention system is an enclosed space where harmful chemicals and vapors can accumulate. Therefore, if the inspection and maintenance requires entering a closed detention system, it should be conducted by an individual trained and certified to work in hazardous confined spaces.

Closed Detention System (Tanks/Vaults)			
Drainage System Feature	Potential Defect	Conditions When Maintenance Is Needed	Minimum Performance Standard
Note: table spans multiple pages			
Storage Area	Plugged Air Vents	One-half of the cross section of a vent is blocked at any point or the vent is damaged.	Vents open and functioning.
	Debris and Sediment	Accumulated sediment depth exceeds 10% of the diameter of the storage area for 1/2 length of storage vault or any point depth exceeds 15% of diameter. (Example: 72-inch storage tank would require cleaning when sediment reaches depth of 7 inches for more than 1/2 length of tank.)	Storage area free of sediment and debris.
	Joints Between Tank/Pipe Section	Any openings or voids allowing material to be transported into facility. (Will require engineering analysis to determine structural stability.)	All joint between tank/pipe sections are sealed.
	Tank Pipe Bent Out of Shape	Any part of tank/pipe is bent out of shape more than 10% of its design shape. (Review required by engineer to determine structural stability.)	Tank/pipe repaired or replaced to design.
	Vault Structure Includes Cracks in Wall, Bottom, Damage to Frame and/or Top Slab	Cracks wider than 1/2-inch and any evidence of soil particles entering the structure through the cracks, or maintenance/inspection personnel determines that the vault is not structurally sound.	Vault replaced or repaired to design specifications and is structurally sound.
			No cracks more than 1/4-inch wide at the joint of the inlet/outlet pipe.
Vegetation Encroachment	Root encroachment of tree or shrub have impacted function or integrity of wetvault.	Roots are found in vault to be removed and repair vault.	
Manhole	Cover Not in Place	Cover is missing or only partially in place. Any open manhole requires maintenance.	Manhole is closed.

Closed Detention System (Tanks/Vaults)

Drainage System Feature	Potential Defect	Conditions When Maintenance Is Needed	Minimum Performance Standard
Note: table spans multiple pages			
	Locking Mechanism Not Working	Mechanism cannot be opened by one maintenance person with proper tools. Bolts into frame have less than 1/2 inch of thread (may not apply to self-locking lids).	Mechanism opens with proper tools.
	Cover Difficult to Remove	One maintenance person cannot remove lid after applying normal lifting pressure. Intent is to keep cover from sealing off access to maintenance.	Cover can be removed and reinstalled by one maintenance person.
	Ladder Rungs Unsafe	Ladder is unsafe due to missing rungs, misalignment, not securely attached to structure wall, rust, or cracks.	Ladder meets design specifications. Allows maintenance person safe access.
Catch Basins	See "Catch Basins"		

Wet Vault

A wet vault is an underground structure similar in appearance to a detention vault, except that a wet vault has a permanent pool of water (wetpool) which dissipates energy and improves the settling of sediment and other pollutants.

Wet vaults are a closed space where harmful chemicals and gasses can accumulate. Therefore, the inspection and maintenance of these facilities should be conducted by an individual trained and certified to work in hazardous confined spaces.

Facility objects that are typically associated with a wet vault include:

- access road or easement
- conveyance stormwater pipe

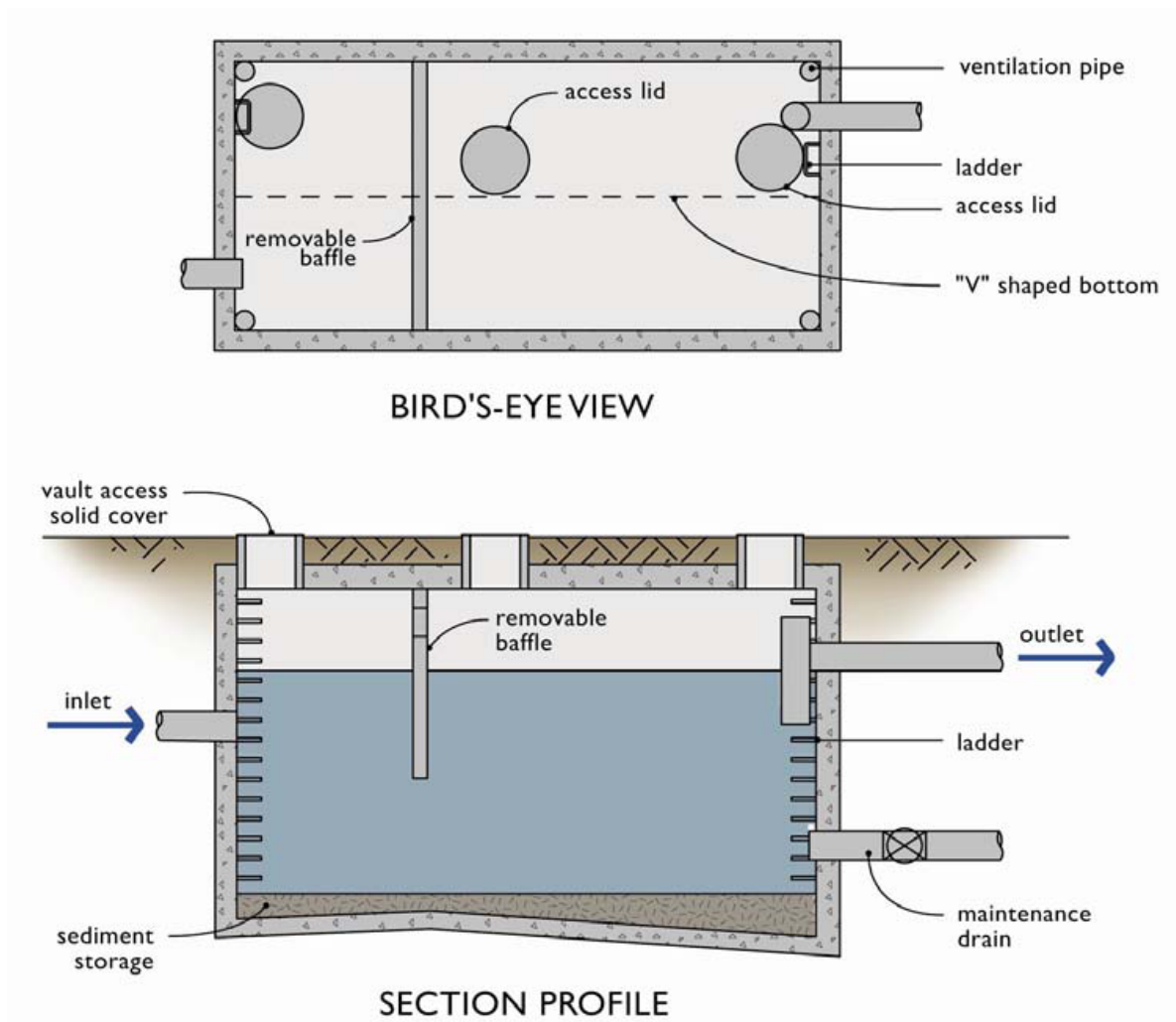

Key Operations and Maintenance Considerations

- The most common tool for cleaning wet vaults is a truck with a tank and vacuum hose (Vactor® truck) to remove sediment and debris from the vault.
- Accumulated sediment and stagnant conditions may cause noxious gases to form and accumulate in the vault. Vault maintenance procedures must meet OSHA confined space entry requirements, which include clearly marking entrances to confined space areas. This may be accomplished by hanging a removable sign in the access riser(s), just under the access lid.
- Sediment should be removed when the sediment zone is full plus 6 inches. Sediments should be tested for toxicants in compliance with current disposal requirements. Sediments must be disposed in accordance with current local health department requirements and the Minimum Functional Standards for Solid Waste Handling. For additional guidance see [Book 3, Appendix 3-E](#), Recommendations for Management of Street Waste.
- Any standing water removed during the maintenance operation must be properly disposed of. The preferred disposal option is discharge to a sanitary sewer at an approved location. Other disposal options include discharge back into the wetpool facility or the storm sewer system if certain conditions are met. For additional guidance see [Book 3, Appendix 3-E](#), Recommendations for Management of Street Waste.

Wet Vault				
Drainage System Feature	Potential Defect	Conditions When Maintenance Is Needed	Minimum Performance Standard	
General	Trash/Debris Accumulation	Trash and debris accumulated in vault, pipe or inlet/outlet (includes floatables and non-floatables).	Vault is free of trash and debris.	
	Sediment Accumulation in Vault	Sediment accumulation in vault bottom exceeds the depth of the sediment zone plus 6-inches.	Vault is free of sediment.	
	Damaged Pipes	Inlet/outlet piping damaged or broken and in need of repair.	Pipe has been repaired and/or replaced to design specifications.	
	Access Cover Damaged/Not Working	Cover cannot be opened or removed, especially by one person.	Cover repaired or replaced to design specifications.	
	Blocked Ventilation	Ventilation area blocked or plugged.	Blocking material has been cleared from ventilation area and removed. A specified % of the vault surface area must provide ventilation to the vault interior (see design specifications).	
	Damage - Includes Cracks in Walls Bottom, Damage to Frame and/or Top Slab		Maintenance/inspection personnel determine that the vault is not structurally sound.	Vault replaced or repairs made such that vault meets design specifications and is structurally sound.
			Cracks wider than 1/2 inch at the joint of any inlet/outlet pipe or evidence of soil particles entering through the cracks.	Vault repaired so that no cracks exist wider than 1/4-inch at the joint of the inlet/outlet pipe.
	Baffles	Baffles corroding, cracking, warping and/or showing signs of failure as determined by maintenance/inspection staff.	Baffles repaired or replaced to design specifications.	
Vegetation Encroachment	Root encroachment of tree or shrub have impacted function or integrity of wetvault.	Roots are found in vault to be removed and repair vault.		
Ladder	Access Ladder Damage	Ladder is corroded or deteriorated, not functioning properly, not attached to structure wall, missing rungs, has cracks and/or misaligned. Confined space warning sign missing.	Ladder replaced or repaired to design specifications, and is safe to use as determined by inspection personnel. Confined space entry warning and requirements sign is present, clean and legible. Ladder and entry notification complies with OSHA standards.	

Modular Detention Systems

Modular detention systems are passive, flow-through, stormwater detention systems that detain (store) stormwater underground. These detention systems function similarly to a detention pond with the temporary storage volume provided by an underground structure to regulate the storm discharge rate from the site. The structure is typically constructed of modular units that provide void space for stormwater detention surrounded by a structural aggregate, filter fabric, and/or membrane to isolate the detention from surrounding material and support various above-ground uses (such as parking, roadways, etc.). These systems are typically utilized for sites that do not have space available for an above-ground system and are more commonly associated with commercial sites. The modular nature allows them to be installed with various sizes to accommodate site-specific detention volumes, and used for sites with irregularly-shaped spaces available for stormwater detention.



Example Proprietary Modular Detention System Installation

(Source: Contech Engineered Solutions)

Key Operations and Maintenance Considerations

- The most common tool for cleaning manufactured modular detention systems is a truck with a tank and vacuum hose (Vactor® truck) to remove sediment and debris.
- Underground detention systems are enclosed spaces where harmful chemicals and vapors can accumulate. Therefore, the inspection and maintenance of these facilities should be conducted by an individual trained and certified to work in hazardous confined spaces.
- Periodic inspections of the inlet and outlet areas to ascertain correct operation of the system.

Stormwater Treatment, Flow Control, and Conveyance Facility Components

- Access and maintenance requirements and methods vary by type of system; some maintenance activities may be accomplished without human entry into the system. Check the manufacturer's publications and the site's maintenance plan for details.

Modular Detention Systems			
Drainage System Feature	Potential Defect	Conditions When Maintenance Is Needed	Minimum Performance Standard
Storage Area	Plugged Air Vents	One-half of the cross section of a vent is blocked at any point or the vent is damaged.	Vents open and functioning.
	Debris and Sediment	Accumulated sediment depth exceeds 10% of the depth of the storage area for 1/2 length of storage area or any point depth exceeds 15% of depth. (Example: 72-inch deep storage area would require cleaning when sediment reaches depth of 7 inches for more than 1/2 length of storage area.)	Storage area free of sediment and debris.
	Leaks in Joints Between Storage/Vault/ Pipe Section	Any openings or voids allowing material to be transported into facility. (Will require engineering analysis to determine structural stability.)	All joints between tank/pipe sections are sealed.
	Tears, Cracks or Leaks in Storage Area Structure	Cracks wider than 1/2 inch and any evidence of soil particles entering the storage area through cracks or tears in top, bottom or walls, or maintenance/inspection personnel determines that the storage area is not structurally sound.	Storage area replaced or repaired to design specifications and is structurally sound. No further evidence of soil particles entering through cracks/tears in enclosure.
	Poor Water Quality	Inspection of discharge water for obvious signs of poor water quality (i.e. obvious oil or other contaminants present).	Effluent discharge from vault clear, without thick visible sheen.
	Other Defects Listed in Manufacturer Specifications or Maintenance Literature	Other damage or defects that prevent the system from functioning to design specifications.	Defects repaired/ corrected per manufacturer's documentation and/ or design specifications.
	Vegetation Encroachment	Root encroachment of tree or shrub have impacted function or integrity of wetvault.	Roots are found in vault to be removed and repair vault.
Manhole (if present)		See "Manhole"	

Media Cartridge Filters

Media cartridge filters are passive, flow-through, stormwater treatment systems. They are comprised of one or more vaults that house rechargeable, media-filled filter cartridges. Stormwater passes through a filtering medium, which traps particulates and/or adsorb pollutants such as dissolved metals and hydrocarbons. Once filtered through the media, the treated stormwater is directed to a collection pipe or discharged into an open channel drainage way.

The filter media can be housed in cartridge filters enclosed in concrete vaults or catch basins. Structures will have vault doors or manhole lids (older designs) for maintenance access. Various types of filter media are available from system manufacturers.

StormFilter® units are an example of a proprietary manufactured media cartridge filter system that is common in Clark County. See manufacturer's publications for additional maintenance information.

Facility objects that are typically associated with a manufactured media filter system include:

- access road or easement
- control structure/flow restrictor
- conveyance stormwater pipe



Media Cartridge Filter Vault with Accumulated Sediment

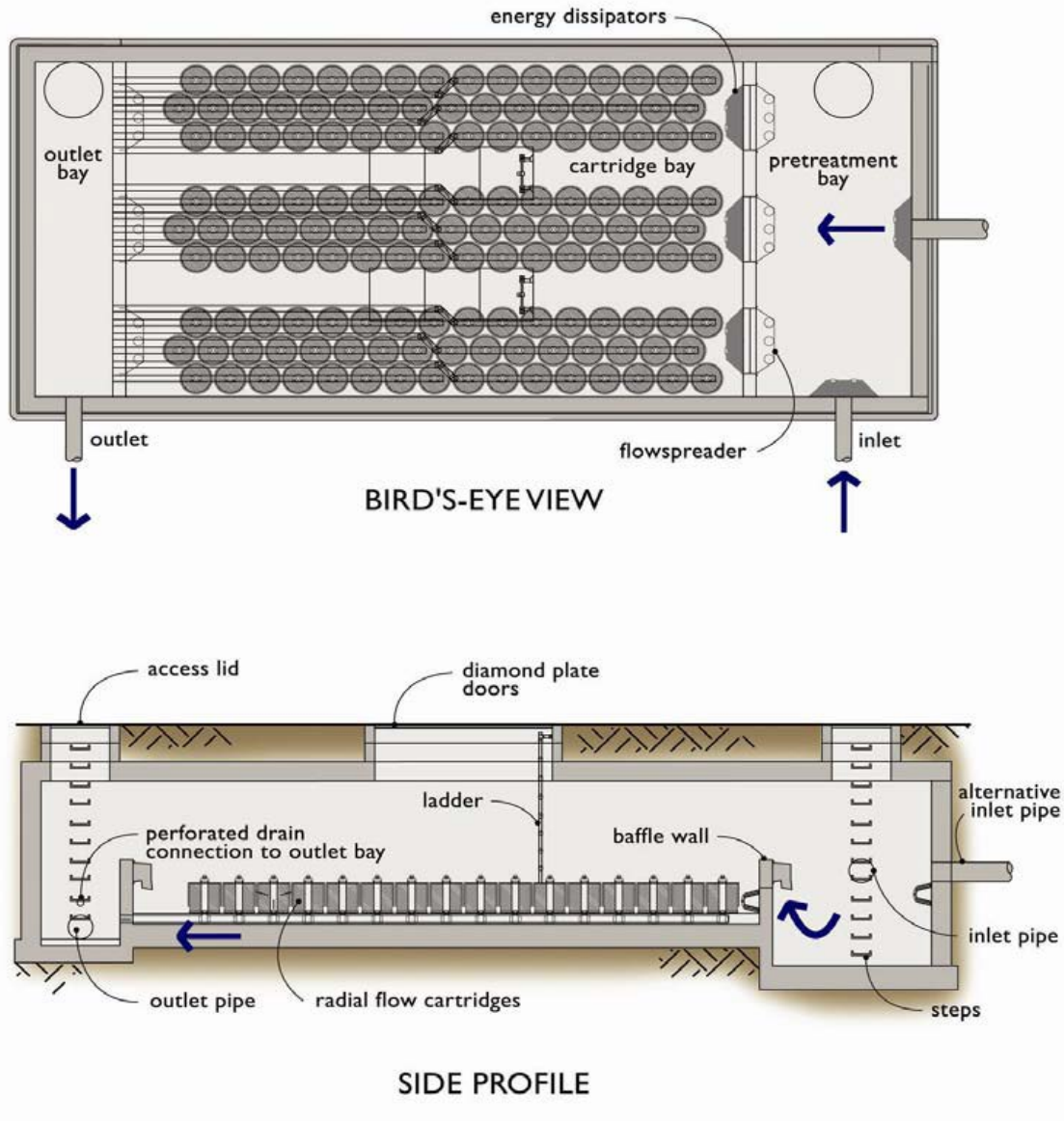

Key Operations and Maintenance Considerations

- The most common tool for cleaning media cartridge filters is a truck with a tank and vacuum hose (e.g. Vactor® truck) to remove sediment and debris from the vault.
- Media cartridge filters are enclosed spaces where harmful chemicals and vapors can accumulate. Therefore, the inspection and maintenance of these facilities should be conducted by an individual trained and certified to work in hazardous confined spaces.
- Cartridges require replacement when the individual cartridges no longer meet the specifications for pollutant removal.

Media Cartridge Filters				
Drainage System Feature	Potential Defect	Conditions When Maintenance Is Needed	Minimum Performance Standard	
Note: table spans multiple pages.				
Forebay	Sediment Accumulation	Sediment accumulation exceeds 6 inches or 1/3 of available sump.	Sediment accumulation less than 6 inches.	
Media Filter Vault	Sediment Accumulation on Top Media Filters (Cartridges)	Sediment depth exceeds 0.25-inches (on top of filter cartridges).	No sediment deposits which would impede permeability of the compost media. No sediment deposits on top of cartridges. (Sediment on cartridges likely indicates that cartridges are plugged and require maintenance.)	
	Sediment Accumulation in Vault	Sediment depth exceeds 4 inches in chamber. Look for other indicators of clogged cartridges or overflow.	No sediment deposits in vault bottom of first chamber. Cartridges have been checked and replaced or serviced as needed.	
	Trash and Debris Accumulation	Trash and debris accumulated in vault.	No trash or debris in vault.	
	Sediment in Drain Pipes/Clean-Outs	When drain pipes, clean-outs, become full with sediment and/or debris.	Sediment and debris has been removed.	
	Damaged Pipes	Any part of the pipes that are crushed or damaged due to corrosion and/or settlement.	Pipe repaired and/or replaced to design specifications.	
	Access Cover Damaged/Not Working	Cover cannot be opened; one person cannot open the cover using normal lifting pressure; corrosion/deformation of cover.	Cover repaired or replaced to design specifications.	
	Vault Structure Includes Cracks in Wall, Bottom, Damage to Frame and/or Top Slab		Cracks wider than 1/2 inch or evidence of soil particles entering the structure through the cracks, or maintenance/inspection personnel determine that the vault is not structurally sound.	Vault replaced or repairs made so that vault meets design specifications and is structurally sound.
			Cracks wider than 1/2 inch at the joint of any inlet/outlet pipe or evidence of soil particles entering through the cracks.	Vault repaired so that no cracks exist wider than 1/4 inch at the joint of the inlet/outlet pipe.
	Baffles Damaged	Baffles corroding, cracking, warping, and/or showing signs of failure as determined by maintenance/inspection person.	Baffles repaired or replaced to design specifications.	
Access Ladder Damaged	Ladder is corroded or deteriorated, not functioning properly, not securely attached to structure wall, missing rungs, cracks, and misaligned.	Ladder replaced or repaired and meets design specifications, and is safe to use as determined by inspection personnel.		
Below Ground Cartridge Type	Compost Media Clogging	Drawdown of water through the media takes longer than 1 hour, and/or overflow occurs frequently.	Media cartridges have been replaced and drawdown time and overflow frequency are per design standards.	

Stormwater Treatment, Flow Control, and Conveyance Facility Components

Media Cartridge Filters			
Drainage System Feature	Potential Defect	Conditions When Maintenance Is Needed	Minimum Performance Standard
Note: table spans multiple pages.			
	Short Circuiting	Flows do not properly enter filter cartridges.	Flows are properly entering filter cartridges. Cartridges have been replaced if necessary.
	Filter Cartridges Submerged	Filter vault does not drain within 24 hours following storm. Look for evidence of submergence due to backwater or excessive hydrocarbon loading.	Filter media have been checked and replaced if needed and vault drains down within 24 of a storm event. (If cartridges are plugged with oil, additional treatment or source control BMP may be needed.)

Planter Box Media Filters

Planter box media filters are passive, flow-through, stormwater treatment systems. They are comprised of a planter box, treatment media and a tree. Stormwater runoff enters the planter box system through a curb-inlet opening or pipe and flows through a specially designed filter media mixture contained in a landscaped concrete container. The filter media captures pollutants; those pollutants are then decomposed, volatilized and incorporated into the biomass of the system's micro/macro fauna and flora. Stormwater runoff flows through the media and into an underdrain system at the bottom of the container.

Filterra® units are an example of a proprietary manufactured filter media planter box system that is becoming more common in Clark County. See manufacturer's publications for additional maintenance information.

Facility objects that are typically associated with a manufactured planter box media filter system include:

- conveyance stormwater pipe

Key Operations and Maintenance Considerations

- The main maintenance need is keeping the mulch surface permeable.
- Filter media may become clogged due to a pollutant discharge.
- The main treatment function is due to the tree roots and soil biota. Dead or severely damaged trees must be replaced.
- Trees may need to be trimmed to provide clear sight lines along roads.

<u>Planter Box Media Filter Systems</u>			
<u>Drainage System Feature</u>	<u>Potential Defect</u>	<u>Conditions When Maintenance is Needed</u>	<u>Minimum Performance Standard</u>
<u>Inlet</u>	<u>Excessive sediment or trash accumulation.</u>	<u>Accumulated sediments or trash impair free flow of water into Filterra.</u>	<u>Inlet should be free of obstructions, allowing free distributed flow of water into Filterra</u>
<u>Mulch Cover</u>	<u>Trash and floatable debris accumulation.</u>	<u>Excessive trash and/or debris accumulation.</u>	<u>Minimal trash or other debris on mulch cover</u>
-	<u>"Ponding" of water on mulch cover.</u>	<u>Clogging due to excessive fine sediment accumulation or spill of petroleum oils.</u>	<u>Stormwater should drain freely and evenly through mulch cover</u>

Stormwater Treatment, Flow Control, and Conveyance Facility Components

<u>Vegetation</u>	<u>Plants not growing or in poor conditions.</u>	<u>Soil/mulch too wet, evidence of spill. Incorrect plant selection. Pest infestation. Vandalism to plants.</u>	<u>Plants should be healthy and pest free.</u>
-	<u>Plant growth excessive</u>	<u>Tree growth inhibits traffic visibility and/or pedestrian access.</u>	<u>Trim tree in accordance with typical landscaping and safety.</u>
<u>Structure</u>	<u>Structure has visible cracks.</u>	<u>Cracks wider than 1/2 inch or evidence of soil particles entering the structure through the cracks.</u>	<u>Vault replaced or repairs made so that vault meets design specifications and is structurally sound.</u>

Bioretention System

Bioretention facilities are engineered facilities that store and treat stormwater by filtering it through a specified soil profile. Water that enters the facility ponds in an earthen depression or other basin (e.g., concrete planter) before it infiltrates into the underlying bioretention soil. Stormwater that exceeds the surface storage capacity overflows to an adjacent drainage system. Treated water is either infiltrated into the underlying native soil or collected by an underdrain and discharged. An underdrain system can be comprised of perforated or slotted pipe, wrapped in an aggregate blanket.

Facility objects that are often associated with a bioretention unit include:

- Inlet
- Overflow
- Underdrains (optional)

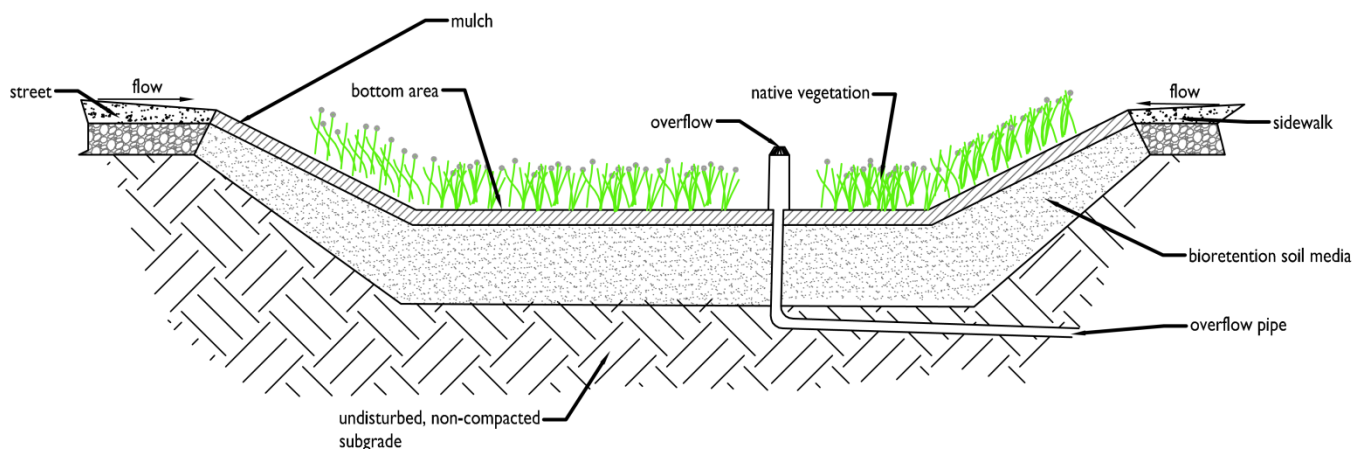

- Signage

Key Operations and Maintenance Considerations

- Protect the facility from external loads (e.g. trucks, riding mowers, other heavy equipment) to preserve the proper function of bioretention soils. Because the risk of compaction is higher when soils are saturated, any type of loading in the bioretention facility (including foot traffic) should be avoided during wet conditions. All maintenance activities must be performed in a manner to prevent compaction of the bioretention soil.
- Erosion control measures must be maintained in areas of concentrated flows (e.g., pipes inlets or narrow curb cuts). Inspect flow entrances, ponding area, and surface overflow areas periodically, and replace soil, plant material, and/or mulch layer in areas if erosion has occurred. Properly

designed facilities with appropriate flow velocities should not have erosion problems except perhaps in extreme events. If erosion problems occur, the following should be reassessed:

- (1) flow volumes from contributing areas and bioretention cell sizing; (2) flow velocities and gradients within the cell; and (3) flow dissipation and erosion protection strategies in the pretreatment area and flow entrance. If sediment is deposited in the bioretention area, immediately determine the source within the contributing area, stabilize, and remove excess surface deposits.
- Establish and follow a maintenance schedule for visual inspection and remove sediment if the volume of the ponding area has been compromised.
- Corrective maintenance for excessive drawdown times may include clearing underdrain obstructions or tilling the bioretention soil media. Partial or complete replacement of bioretention soil media may be necessary.
- Regular maintenance of vegetation includes weeding and pruning. Plants require irrigation during the first 2 to 3 years of establishment and during extended dry periods. Replace all dead plants and, if specific plants have a high mortality rate, assess the cause and replace with appropriate species.
- The soil mix and plants are selected for optimum fertility, plant establishment, and growth. Nutrient and pesticide inputs should not be required and may degrade the pollutant processing capability of the bioretention area, as well as contribute pollutant loads to receiving waters. If in question, have soil analyzed for fertility.
- Replace mulch annually in bioretention facilities where heavy metal deposition is high (e.g., contributing areas that include gas stations, ports and roads with high traffic loads). In residential settings or other areas where metals or other pollutant loads are not anticipated to be high, replace or add mulch as needed (likely 3 to 5 years) to maintain a 2 to 3 inch depth.
- Soil mixes for bioretention facilities are designed to maintain long-term fertility and pollutant processing capability. Estimates from metal attenuation research suggest that metal accumulation should not present an environmental concern for at least 20 years in bioretention systems, but this will vary according to pollutant load. Replacing mulch media in bioretention facilities where heavy metal deposition is likely provides an additional level of protection for prolonged performance. If in question, have soil analyzed for fertility and pollutant levels.
- Presence of pests such as geese or rodents can generally be corrected by ensuring that drawdown time matches facility design function and plants are spaced at proper densities.
- If an underdrain is present, remove trash, debris and sediment from the inlet orifice biannually.
- Irrigate or hand-water vegetation as needed to help plants establish in the first few years after installation and as needed after plants are established. The following schedule is recommended:
 - Provide summer watering deeply, but infrequently, every one to two weeks during the first summer or as needed during prolonged dry periods.

- Provide summer watering deeply, but infrequently, every two to four weeks during the second and third summers or as needed during prolonged dry periods.
- Provided summer watering as needed after plants are established.

Plant Material

Table 7: Plant List for Bioretention System and Rain Garden*

Moist to Wet Soil Conditions (Facility Bottom to Bottom of Overflow)			Table continues next page.	
Type	Botanical Name	Common Name	O.C. Spacing	Allowed ROW**
Herbaceous	<i>Carex densa</i>	Dense sedge	12"	Y
Herbaceous	<i>Carex morrowii</i>	Ice Dance	12"	Y
Herbaceous	<i>Carex obnupta</i>	Slough Sedge	12"	N
Herbaceous	<i>Deschampsia cespitosa</i>	Tufted Hair Grass	12"	N
Herbaceous	<i>Juncus patens</i>	Spreading Rush	12"	Y
Shrub	<i>Cornus sericea 'Kelseyii'</i>	Kelsey Dogwood	24"	Y
Shrub	<i>Spiraea betulifolia</i>	Birchleaf Spiraea	24"	N
Shrub	<i>Spiraea densiflora</i>	Sub-alpine Spiraea	24"	Y
Shrub	<i>Spiraea japonica</i>	Japanese spirea cultivars	24"	Y
Groundcover	<i>Rubus calcynoides & pentalobus</i>	Creeping Bramble	12"	N
Accent	<i>Camassia leichtinii</i>	Great Camas	12"	N
Accent	<i>Camassia quamash</i>	Common Camas	12"	N
Tree	<i>Acer campestre 'Evelyn'</i>	Elizabeth Hedge Maple	30'	Y
Tree	<i>Betula jacquemontii</i>	Jacquemontii Birch	60'	N
Tree	<i>Celtis occidentalis</i>	Hackberry	50'	N
Tree	<i>Koelreuteria paniculata</i>	Goldenrain Tree	30'	Y
Tree	<i>Nyssa sylvatica</i>	Black tupelo	50'	Y
Tree	<i>Prunus virginiana 'Canada Red'</i>	Canada Red Chokecherry	25'	Y
Tree	<i>Quercus shumardii</i>	Shumard Oak	70'	Y
Tree	<i>Rhamnus purshiana</i>	Cascara	30'	N
Dry Soil Conditions (Overflow and Above)			O.C. Spacing	Allowed ROW
Type	Botanical Name	Common Name		
Herbaceous	<i>Deschampsia cespitosa</i>	Tufted Hair Grass	12"	N
Herbaceous	<i>Helictotrichon sempervirens</i>	Blue Oat Grass	12"	Y
Shrub	<i>Cornus sericea 'Kelseyii'</i>	Kelsey Dogwood	24"	Y
Shrub	<i>Euonymous japonicas 'Microphyllus'</i>	Boxleaf Evergreen	24"	Y
Shrub	<i>Mahonia aquifolium 'Compacta'</i>	Oregon Grape	24"	Y
Shrub	<i>Spiraea betulifolia</i>	Birchleaf Spiraea	24"	N
Shrub	<i>Spiraea densiflora</i>	Sub-alpine Spiraea	24"	Y

Stormwater Treatment, Flow Control, and Conveyance Facility Components

Shrub	<i>Spiraea japonica</i>	Japanese spirea cultivars	24"	Y
Groundcover	<i>Arctostaphylos uva-ursi</i>	Kinnickinnick	12"	Y
Groundcover	<i>Fragaria chiloensis</i>	Coastal Strawberry	12"	Y
Groundcover	<i>Mahonia repens</i>	Creeping Oregon Grape	12"	N
Accent	<i>Camassia leichtinii</i>	Great Camas	12"	N
Accent	<i>Camassia quamash</i>	Common Camas	12"	N
Accent	<i>Iris douglasiana</i>	Douglas Iris	12"	N
Accent	<i>Iris tenax</i>	Oregon Iris	12"	N
Tree	<i>Acer campestre 'Evelyn'</i>	Elizabeth Hedge Maple	30'	Y
Tree	<i>Betula jacquemontii</i>	Jacquemontii Birch	60'	N
Tree	<i>Celtis occidentalis</i>	Hackberry	50'	N
Tree	<i>Koelreuteria paniculata</i>	Goldenrain Tree	30'	Y
Tree	<i>Prunus virginiana 'Canada Red'</i>	Canada Red Chokecherry	25'	Y
Tree	<i>Quercus shumardii</i>	Shumard Oak	70'	Y
Tree	<i>Rhamnus purshiana</i>	Cascara	30'	N

Selected plants shall not include any plants from the State of Washington Noxious Weed List. Refer to clark.wa.gov/weed/ for a current list of noxious weeds.

*Adapted from Portland Bureau of Environmental Services 2014 Stormwater Management Manual, Appendix F.4., Planting Templates and Plant Lists

** Plant species allowed in Clark County street Rights of Way

Bioretention System			
Drainage System Feature	Potential Defect	Conditions When Maintenance Is Needed	Minimum Performance Standard
Note: table spans multiple pages.			
General	Pests	Signs of pest infestations (IPM protocol threshold(s) are exceeded), including rodent holes or mounds that disturb dispersion flow paths.	<p>Pests are not present or engaged in activities that present a significant public health risk or compromise to the intended design function of the facility. Pests that have exceeded acceptable thresholds have been addressed using appropriate IPM measures.</p> <p>Standing water that may allow mosquito breeding has been removed and cause of standing water has been addressed (see "Ponded Water").</p> <p>Pest-damaged vegetation has been removed.</p>
Facility Area	Trash and Debris	Trash and debris present in facility area.	Facility area is free of trash and debris.

Bioretention System			
Drainage System Feature	Potential Defect	Conditions When Maintenance Is Needed	Minimum Performance Standard
Note: table spans multiple pages.			
	Pet Waste	Large volumes of feces from domestic pets are present.	Pet waste removed. Pet waste station or additional signage installed, if appropriate.
	Mulch	Mulch depth is less than 2 inches or the facility has bare spots without mulch cover.	Mulch has been restored to a depth of 2 to 3 inches and is appropriate to the location within the facility (e.g. compost mulch in the bottom and wood chips on side slopes).
Facility Bottom Area	Sediment	Sediment accumulated to extent that infiltration rate is reduced, water can be seen to be ponding, or surface storage capacity is significantly impacted.	Source of sediment has been identified and controlled. Excess sediment has been removed, and damaged vegetation and mulch has been replaced.
	Leaves	After fall leaf drop, leaves have accumulated in the facility in a manner to pose a risk of impeding water flow or clogging the outlet.	Leaves have been removed.
	Ponded Water	Water overflows during storms smaller than the design event, or ponded water remains in the basin more than 48 hours after the end of a storm.	Cause of excessive ponding has been identified by investigating: 1) potential that debris build-up is impeding infiltration; 2) condition of underdrain (if present); 3) potential that other water inputs are present (e.g. groundwater, illicit connections); 4) facility size is appropriate to contributing area; and 5) condition of bioretention soil media. Cause of excessive ponding has been corrected. Engineer has been consulted where necessary.
Earthen Side Slopes and Berms	Erosion At Inlets/ Outlets	Erosion (gullies/ rills) greater than 2 inches deep around inlets, outlet, and alongside slopes.	For channels or cuts over 3 inches deep, temporary erosion control measures have been put into place until permanent repairs are made. Source of erosion has been addressed/ eliminated and eroded areas repaired per design specifications, with additional stabilizing material (cobbles, vegetation, etc.) added as necessary.
	Erosion of Side Slopes	Erosion of sides causes slope to become a hazard.	Source of erosion has been addressed and side slopes repaired to design specifications. Slopes have stabilizing material where necessary.
	Settlement	Settlement greater than 3 inches (relative to undisturbed sections of	Slopes and berm have been restored to design elevations/ heights.

Stormwater Treatment, Flow Control, and Conveyance Facility Components

Bioretention System			
Drainage System Feature	Potential Defect	Conditions When Maintenance Is Needed	Minimum Performance Standard
Note: table spans multiple pages.			
		berm).	
	Berm Leaking	Downstream face of berm wet; seeps or leaks evident.	Any seeps or leaks have been plugged and berm material and compaction are per design specifications. Engineer has been consulted where necessary.
	Rodents In Berm	Any evidence of rodent holes or water piping in berm.	Rodents have been eradicated (see "Pests In Facility"). Holes have been filled and berm compacted (see "Berm Leaking").
Concrete Sidewalls	Damage to Concrete	Cracks or failure of concrete sidewalls.	Concrete sidewalls have been repaired, or replaced if repair is insufficient.
Rockery Sidewalls	Rockery Sidewalls Insecure	Rockery sidewalls are insecure.	Rockery sidewalls have been repaired to design standard, with consultation/ inspection by a professional engineer as necessary (walls over 4 foot height).
Low Permeability Check Dams and Weirs	Sediment or Other Debris Blocking	Sediment, vegetation, or debris accumulated at or blocking (or having the potential to block) check dam, flow control weir or orifice.	No blockage present of check dam, flow control weir, or orifice. Any likely immediate sources of additional debris or sediment (e.g. additional dead plant material, erosion issue, etc. upstream) addressed or removed.
	Erosion or Undercutting	Erosion and/or undercutting present.	Eroded and/or undercut areas have been repaired and sources of issue addressed to prevent further erosion/undercutting at weir.
	Grade Board Not Level	Grade board or top of weir damaged or not level.	Grade board is undamaged (repaired or replaced) and level.
Inlet	Erosion at Inlet	Concentrated flows are causing erosion at inlet.	A cover of rock or cobbles or other erosion protection measure (e.g., matting) is in place to protect the ground where concentrated water enters the facility (e.g., a pipe, curb cut or swale).
Splash Block Inlet	Water Misdirected from Inlet	Water is not being directed properly to the facility and away from the inlet structure.	Splash block(s) reconfigured/ repaired to direct water to facility and away from structure.
Curb Inlet/Outlet	Leaf Accumulation at Curb Cut	Accumulated leaves or other debris at curb cuts (inlets and outlets) can block water flow and proper function of the facility. Maintenance is particularly important in the fall.	Curb cuts and adjacent gutters are free of leaves and debris, and water can flow freely into (and out of) the facility.
Pipe Inlet/Outlet	Pipe Is Damaged	Pipe is damaged.	Pipe repaired or replaced to design specifications.
	Pipe Is Clogged	Pipe is clogged, completely or partially. Problem material may include leaves, debris, trash, roots, sediment, or other material.	Pipe is unclogged and free of any obstructions. Pipe functioning at design capacity.

Bioretention System			
Drainage System Feature	Potential Defect	Conditions When Maintenance Is Needed	Minimum Performance Standard
Note: table spans multiple pages.			
	Access Is Blocked	Vegetation is blocking access for inspection.	Area within 1 foot of inlets/outlets is clear of vegetation, and access pathways are clear and maintained where necessary.
Trash Rack	Trash and Debris	Trash or other debris is present on trash rack. Capacity may be reduced by buildup of trash or debris.	Trash rack is free of trash, leaves, debris, or other foreign material.
	Bar Screen Damage	Bar screen on trash rack is damaged or missing.	Bar screen has been repaired/ replaced to design specifications.
Overflow	Overflow Blocked	Overflow capacity is reduced by sediment or debris.	Overflow area is free of sediment and debris and capacity functions per design standards.
Underdrain Pipe	Reduced Capacity	Plant roots, sediment, or debris may reduce the capacity of the underdrain. Symptoms may include ponded water in facility bottom area.	Underdrain pipe is free of plant roots, sediment and debris. Infiltration and pipe capacity functioning per design function.
Vegetation (continues on next page)	Poor Vegetation Health	Less than 75% of planted vegetation is healthy with a generally good appearance (unless project O&M manual or record drawing stipulates more or less than 75% survival rate).	At least 75% of planted vegetation is healthy with generally good appearance. Any conditions found that were deleterious to plant health have been corrected where possible. Routine maintenance schedule, including watering, has been updated as necessary to ensure continued plant health and satisfactory appearance.
	Diseased Plant Material	Diseased plants or plant material is present in the facility.	Diseased plants and plant parts have been removed and disposed of in an approved location (off-site). Potential sources of and conditions exacerbating disease have been addressed (see Pacific Northwest Plant Disease Management Handbook). Vegetated areas replanted as necessary to maintain vegetative coverage per design.
	Vegetation Needs Pruning	Trees and shrubs need regular maintenance and/or corrective pruning.	Trees and shrubs pruned per routine maintenance schedule, appropriate to individual species and age of plants. All pruning of mature trees done under direct supervision of ISA certified arborist.
	Large Trees and Shrubs Interfering	Large trees and shrubs interfere with operation of the facility or access for maintenance.	Trees and shrubs have been pruned using most current ANSI A300 standards and ISA BMPs. Trees and shrubs removed if necessary for operation of facility per design function.
	Dead Vegetation	Standing dead vegetation is present (particularly in fall and spring).	Standing dead vegetation has been removed from site; gaps in vegetation have been replaced with new plantings where necessary, or appropriate erosion control measures put in place until vegetation

Stormwater Treatment, Flow Control, and Conveyance Facility Components

Bioretention System			
Drainage System Feature	Potential Defect	Conditions When Maintenance Is Needed	Minimum Performance Standard
Note: table spans multiple pages.			
			replacement is feasible.
	Maintenance Needed Around Mature Trees	If conditions warrant maintenance work or planting of new vegetation around mature trees (within the dripline), appropriate care must be taken to avoid adverse impacts to the mature tree(s).	The most current ANSI A300 standards and ISA BMPs have been followed to the extent practicable (e.g., take care to minimize any damage to tree roots and avoid compaction of soil) when working around and under mature trees. New plantings under mature trees include mainly plants that come as bulbs, bare root or in 4-inch pots; new plants in no larger than 1-gallon containers.
	Stakes or Guys Present	Stakes or guys present in plantings installed for over 1 year.	Stakes or guys have been removed from new vegetation after 1 year since installation. Holes have been backfilled where necessary.
	Vehicular Sight Lines Impaired By Vegetation	Vegetation causes some visibility (line of sight) or driver safety issues.	Vegetation has been pruned to appropriate height and spread to maintain sight clearances. If continued (regular) pruning of a given plant have been necessary, plant(s) have been relocated to a more appropriate location and replaced with plant(s) of appropriate mature size.
	Emergent Vegetation Compromises Conveyance	Emergent vegetation compromises conveyance (may become too dense).	Emergent vegetation has been thinned and does not impede conveyance.
	Noxious Weeds Present	Noxious weeds are present among the site vegetation. Remove, bag, and dispose of Class A & B noxious weeds immediately per WA law. Make reasonable attempts to remove and dispose of Class C noxious weeds. See http://www.nwcb.wa.gov/ . Follow Integrated Pest Management (IPM) protocols.	Noxious weeds are not present on site above thresholds established by WA law.

Permeable Pavement

Permeable pavement is a paving system which allows rainfall to percolate through the surface into the underlying soil or an aggregate bed, where stormwater is stored and infiltrated to underlying soil, or removed by an overflow drainage system.

Facility elements that are typically associated with permeable pavement include:

- Wearing course: The surface layer of any permeable pavement system is the wearing course. Categories of wearing courses include:
 - Porous asphalt: A flexible pavement similar to standard asphalt that uses a bituminous binder to adhere aggregate. However, the fine material (sand and finer) is reduced or eliminated, resulting in the formation of voids between the aggregate in the pavement surface that allows water to infiltrate to the underlying aggregate base.
 - Pervious concrete: A rigid pavement similar to conventional concrete that uses a cementitious material to bind aggregate together. However, the fine aggregate (sand) component is reduced or eliminated in the gradation, resulting in the formation of voids between the aggregate in the pavement surface that allows water to infiltrate to the underlying aggregate base.
 - Interlocking concrete paver blocks: Solid, precast, manufactured modular units. Pavements constructed with these units create joints that are filled with permeable aggregate and installed on an open-graded aggregate base.
 - Aggregate Pavers (or Pervious Pavers): Modular precast paving units made with uniformly sized aggregates and bound with Portland cement concrete using a high strength adhesive. Unlike concrete paver blocks, these pavers are permeable. Pavements constructed with these units create joints that are filled with permeable aggregate and installed on an open-graded aggregate base.
 - Open-celled paving grid with gravel: Concrete or plastic grids that are filled with permeable aggregate. The system can be installed on an open-graded aggregate base.
 - Open-celled paving grid with grass: Concrete or plastic grids that are filled with a mix of sand, gravel, and topsoil for planting vegetation. The cells can be planted with a variety of non-turf forming grasses or low-growing groundcovers. The system can be installed on an open-graded aggregate base.
- Inlet (optional): While permeable pavement facilities often manage only the rain falling directly on the pavement surface, they may also be designed to accept stormwater runoff from additional areas (e.g., adjacent impervious areas, nearby rooftops). Runoff can be directed to the facility by two main methods:
 - Sheet flow to the surface: Surface areas of the facility receiving runoff contributions will likely be prone to clogging due to sediment inputs, particularly in areas of concentrated inflow. These areas should be carefully inspected and corrective

maintenance should be performed as necessary to maintain the function of the pavement at these sites. In addition, the source of the sediment loads should be evaluated to determine if modifications to features in the drainage area landscape (e.g., stabilization of adjacent planted areas) would help to prevent clogging.

- Piped flow into the aggregate base: Pipes dispersing water into the aggregate bed should be designed with cleanout access to allow pipe maintenance. Runoff that is piped into the aggregate base should be pretreated for sediment removal (e.g., screens, sumps) to protect the subbase from sedimentation and clogging. The pretreatment system must be maintained to remove accumulated sediment.
- Aggregate Base / Storage Reservoir: Stormwater passes through the wearing course to an underlying aggregate storage reservoir where it is stored prior to infiltration into the underlying soil. This aggregate bed also provides the structural function of supporting design loads (e.g., vehicle loading) for flexible pavement systems. To allow inspection of the aggregate course, some facilities have an observation port (typically installed during construction) that allows monitoring of the water levels in the aggregate bed to determine if the facility is draining properly.
- Overflow: Unless designed to provide full infiltration of stormwater, permeable pavement facilities have an overflow. Facility overflow can be provided by subsurface slotted drain pipe(s) (elevated in the aggregate bed) routed to an inlet or catch basin structure or by lateral flow through the storage reservoir to a daylighted drainage system.
- Underdrain with flow restrictor (optional): A slotted drain pipe with flow restrictor assembly may be installed at the bottom of or elevated within the aggregate storage reservoir. Permeable pavement facilities with underdrains and flow restrictors operate as underground detention systems with some infiltration.
- Signage or pavement marking can also be used to identify permeable pavement as a stormwater BMP and inform maintenance crews and the general public about protecting the facility's function (e.g., no stockpiling of soils or mulch on pavement surface).

Key Operations and Maintenance Considerations

- Installations can be monitored for adequate or designed minimum infiltration rates by observing drainage immediately after heavier rainstorms for standing water or infiltration tests using ASTM C1701.
- The following practices are recommended to maintain proper function of porous pavement systems:
 - Do not use of sealant on porous asphalt
 - Protect from construction site runoff with proper temporary erosion and sediment controls and flow diversion measures
 - Modifying utility cut procedures for permeable pavements - Protocols should recommend restoring permeable pavement section in-kind, where feasible, and

require restoring permeable pavement section in-kind where replacement with conventional pavement would impact overall facility function. Utility cuts should be backfilled with the same aggregate base used under the permeable paving to allow continued conveyance of stormwater through the base, and to prevent migration of fines from the standard base aggregate to the more open graded permeable base material (Diniz, 1980). Replacing permeable pavement with conventional pavement is acceptable if it is a small percentage of the total facility area and does not impact the overall facility function.

- A critical component of a successful maintenance program is regular removal of sediment, debris and excessive moss from the facility surface to prevent clogging of the permeable wearing course. Surrounding landscaped areas should be inspected regularly and possible sediment sources controlled immediately.
- Protect the surface from stockpiles of landscaping materials (e.g., mulch, soil, compost).
- Clean permeable pavement surfaces to maintain infiltration capacity at least once or twice annually following recommendations below.
 - Porous asphalt and pervious concrete
 - Clean surfaces using suction, sweeping with suction or high-pressure wash and suction (sweeping alone is minimally effective). Hand held pressure washers are effective for cleaning void spaces and appropriate for smaller areas such as sidewalks.
 - Small utility cuts can be repaired with conventional asphalt or concrete if small batches of permeable material are not available or are too expensive.
 - Permeable pavers
 - The Interlocking Concrete Paving Institute (ICPI) recommends cleaning if the measured infiltration rate falls below 10 inches per hr.
 - Use sweeping with suction when surface and debris are dry 1-2 times annually (see next bullet for exception). Apply vacuum to a paver test section and adjust settings to remove all visible sediment without excess uptake of aggregate from paver openings or joints. If necessary replace No 8, 89 or 9 stone to specified depth within the paver openings. Washing or power washing should not be used to remove debris and sediment in the openings between the pavers.
 - For badly clogged installations, wet the surface and vacuum aggregate to a depth that removes all visible fine sediment and replace with clean aggregate.
 - If necessary use No 8, 89 or 9 stone for winter traction rather than sand (sand will accelerate clogging).
 - Replace broken pavers as necessary to prevent structural instability in the surface.

Stormwater Treatment, Flow Control, and Conveyance Facility Components

- Plastic or Concrete grid systems
 - Remove and replace top course aggregate if clogged with sediment or contaminated (vacuum trucks for stormwater collection basins can be used to remove aggregate).
 - Remove and replace grid segments where three or more adjacent rings are broken or damaged.
 - Replenish aggregate material in grid as needed.
 - For grass installations, use normal turf maintenance procedures except do not aerate. Use very slow release fertilizers if needed.
- Modify typical snow removal procedures, such as:
 - Using a snow plow with skids or rollers to slightly raise the blade above permeable pavers or open-celled paving grid systems to prevent loss of top course aggregate and damage to paver blocks or grids.
 - Avoiding stockpiling plowed snow (i.e., dirty snow) directly on top of permeable pavement.
 - Use deicers in moderation (e.g., salt, molasses-based and chemical deicers) if needed.

Maintenance Standards

The table below provides the minimum required maintenance standards for permeable pavement components. The level of routine maintenance required and the frequency of corrective maintenance actions may increase for facilities receiving high sediment loads (e.g., sanding) or facilities subject to extended wet, shady conditions where moss may accumulate.

Permeable Pavement			
Drainage System Feature	Potential Defect	Conditions When Maintenance Is Needed	Minimum Performance Standard
Note: table spans multiple pages.			
Permeable Pavements (all)	Material Deposited on Pavement	Runoff from adjacent pervious areas deposits soil, mulch or sediment on paving.	Soil, mulch or sediment from adjacent areas has been removed from permeable pavement and measures taken to prevent further deposition of soil/ mulch material from adjacent areas on permeable pavement.
	Vegetative Debris	Accumulation of organic debris and leaf litter. Vegetation related fallout clogs or will potentially clog voids.	Vegetative debris removed and sources trimmed/ pruned as appropriate to reduce further debris accumulation. Water infiltrates per design function.

Permeable Pavement			
Drainage System Feature	Potential Defect	Conditions When Maintenance Is Needed	Minimum Performance Standard
Note: table spans multiple pages.			
Porous Asphalt or Pervious Concrete	Surface Clogged	Surface is clogged: Ponding on surface or water flows off the permeable pavement surface during a rain event (does not infiltrate). Infiltration rate testing using ASTM C1701 indicates an infiltration rate of 10 inches per hour or less.	Surface has been cleaned/ cleared of sediment, debris, vegetation or other material and water infiltrates per design function.
	Sediment On Surface	Sediment present at the surface of the pavement.	Source of sediment has been identified and addressed, if possible. Surface of pavement is free of sediment.
	Moss Growth On Pavement	Moss growth inhibits infiltration or poses slip safety hazard.	Moss removed such that there is not a slip safety hazard and pavement infiltrates per design function.
	Pavement Damaged	Major cracks or trip hazards and concrete spalling and raveling.	Cracks or other damage to pavement repaired to grades and tolerances per design specifications; infiltration functions per design.
Interlocking Concrete Paver Blocks and Aggregate Pavers	Surface Clogged	Surface is clogged: Ponding on surface or water flows off the permeable pavement surface during a rain event (does not infiltrate).). Infiltration rate testing using ASTM C1701 indicates an infiltration rate of 10 inches per hour or less.	Surface has been cleaned/ cleared of sediment, debris, vegetation or other material and water infiltrates per design function.
	Settlement	Settlement of pavement surface (may indicate other problems).	Pavement restored to finished grades per design specifications and record drawings. Surface drainage function restored.
	Sediment On Surface	Sediment present at the surface of the pavement.	Surface of pavement is free of sediment and infiltrates per design function.
	Moss Growth On Pavement	Moss growth inhibits infiltration or poses slip safety hazard.	Moss removed such that there is not a slip safety hazard and pavement infiltrates per design function.
	Pavers Missing/ Damaged	Paver block(s) are missing or damaged.	Paver blocks repaired or replaced per design specifications and record drawings.
	Loss Of Aggregate	Loss of aggregate material between paver blocks.	Aggregate replaced per design specifications and paver manufacturer's recommendations.
	Settlement	Surface has settled in a manner that poses a safety hazard or inhibits infiltration.	Pavers restored to finished grades per design specifications and record drawings.
Open-Celled Paving Grid With Gravel	Aggregate Clogged	Aggregate is clogged: Ponding on surface or water flows off the permeable pavement surface during a rain event (does not infiltrate).	Aggregate has been cleaned/ cleared of sediment, debris, vegetation or other material and water infiltrates per design function.
	Paving Grid Missing/ Damaged	Paving grid missing or damaged.	Paving grid replaced or restored per design specifications and record drawings.

Stormwater Treatment, Flow Control, and Conveyance Facility Components

Permeable Pavement			
Drainage System Feature	Potential Defect	Conditions When Maintenance Is Needed	Minimum Performance Standard
Note: table spans multiple pages.			
	Settlement	Settlement of pavement surface (may indicate other problems).	Pavement restored to finished grades per design specifications and record drawings.
	Loss Of Aggregate	Loss of aggregate in paving grid.	Aggregate replaced per design specifications.
Open-Celled Paving Grid With Grass	Aggregate Clogged	Aggregate is clogged: Ponding on surface or water flows off the permeable pavement surface during a rain event (does not infiltrate).	Surface has been rehabilitated per manufacturer's recommendations and water infiltrates per design function.
	Paving Grid Missing/ Damaged	Paving grid missing or damaged.	Paving grid and grass surface replaced or restored per design specifications and record drawings.
	Settlement	Settlement of pavement surface (may indicate other problems).	Pavement restored to finished grades per design specifications and record drawings.
	Poor Grass Coverage	Poor grass coverage in paving grid.	Grass coverage restored per design specifications and manufacturer's recommendations.
Inlets/ Outlets/ Pipes	Inlet/ Outlet Pipe Damaged	Pipe is damaged.	Damaged pipe has been repaired/ replaced and flow capacity functions per design.
	Inlet/ Outlet Pipe Clogged	Pipe is clogged.	Pipe has been cleared and flow capacity functions per design.
	Underdrain Pipe Clogged	Plant roots, sediment or debris reducing capacity of underdrain (may cause prolonged drawdown period).	Pipe has been cleared and infiltration rate/ flow capacity of system functions per design.
	Raised Subsurface Overflow Pipe Clogged	Plant roots, sediment or debris reducing capacity of underdrain.	Pipe has been cleared and infiltration rate/ overflow capacity of system functions per design specifications.
	Outlet Structure Clogged	Sediment, vegetation, or debris reducing capacity of outlet structure.	Blockage has been cleared and outlet structure functions at full capacity per design.
	Erosion At Overflow	Native soil is exposed or other signs of erosion damage are present at discharge point.	Erosion has been repaired and eroded area stabilized.
Observation Port	Water Visible In Storage Aggregate	Water remains in the storage aggregate longer than anticipated by design after the end of a storm.	Cause or ponding investigated and addressed as needed to bring facility into conformance with design function.

Vegetated Roof

Vegetated roofs (also known as ecoroofs and green roofs) are thin layers of engineered soil and vegetation constructed on top of a conventional roof. Vegetated roofs consist of four basic components: a waterproof membrane, drainage layer, lightweight growth medium, and vegetation. Deeper installations, referred to as **intensive** roofs, are comprised of at least 6 inches of growth media and are planted with groundcovers, grasses, shrubs and sometimes trees. These intensive systems require regular landscape maintenance. Shallower installations, referred to as **extensive** roofs, are comprised of less than 6 inches of growth media and use a planting palette of drought-tolerant, low maintenance groundcovers. The procedures outlined below focus on extensive roof systems, and different procedures for intensive roofs are noted.

Facility elements that are typically associated with vegetated roofs include:

- **Waterproof membrane:** Waterproof membranes are installed on the roof deck below the vegetated roof system. Systems also include a protection layer and root barrier to preserve the integrity of the waterproof membrane. These components are not visible, so inspection is typically not possible unless a leak detection system is installed.
- **Drainage layer:** All vegetated roofs have a drainage component that routes excess water to the roof drain system. Usually this takes the form of a manufactured drain mat or granular drainage media. A separation layer (e.g., filter fabric) is typically installed above the drainage mat or granular drainage media to prevent fine components of the growth media from being washed into the roof drain system. This component is also not visible, so inspection is difficult.
- **Growth media:** Vegetated roofs use a light-weight growth medium with adequate fertility and drainage capacity to support plant growth and allow infiltration and storage of water. In general the media is composed of porous and lightweight mineral aggregates such as pumice, lava rock, expanded shale and expanded slate. The growth media may be covered by a mat (or other erosion control measure) to prevent surface erosion due to rain and wind scour before plants are established.
- **Vegetation:** The plants on vegetated roofs are typically succulents, grass, herbs, and/or wildflowers adapted to the harsh conditions (minimal soils, seasonal drought, high winds, and strong sun exposure) prevalent on rooftops. A wider variety of vegetation types may be used on intensive roofs, but these typically require additional maintenance.
- **Structural drainage elements:** The roof drainage system routes water from the vegetated roof drainage layer to a nearby drainage system. There are also other structural components of a roof that may interface with the vegetated roof (e.g., flashing, roof ventilation points, utilities).
- **Border zone:** This zone forms an area, composed of gravel and devoid of vegetation, around the perimeter of the vegetated roof, typically used as a fire prevention method and to prevent water damage.

- Gravel stops: These are sheet metal edges, typically installed outside of the border zone, along the perimeter of the roof to prevent growth medium from blowing or washing off of the roof.
- Signage: Signage is recommended to identify the planted areas of the vegetated roof as a stormwater BMP and educate maintenance crews and the general public about protecting the facility's function (e.g., no walking on the facility). Clear walkways or pathways should be present to discourage foot traffic on the planted portions of the vegetated roof.

Key Operations and Maintenance Considerations

- Similar to bioretention facilities, filtration can be reduced if the growth media is subject to compaction (e.g., foot traffic). The planted area of the vegetated roof should be protected from external loads. The risk of compaction is higher when soils are saturated, therefore any type of loading in the planted areas of the vegetated roof (including foot traffic) should be avoided or minimized during wet conditions.
- During maintenance, sharp tools, lawn staples, and stakes should be avoided to prevent damage to waterproof membrane and drainage layer.
- Regular maintenance activities associated with green roof vegetation include weeding and pruning. Plants also require watering during establishment and extended dry periods.
- Maintain unobstructed outlet pipes and structures to ensure that stormwater is safely conveyed from the roof to a discharge point.

Maintenance Standards

The table below provides the minimum required maintenance standards for vegetated roof components.

Each vegetated roof installation will have specific O&M guidelines provided by the manufacturer and installer. The following guidelines provide a general set of standards for prolonged vegetated roof performance. Note that some maintenance recommendations are different for extensive versus intensive vegetated roof systems.

Vegetated Roof			
Drainage System Feature	Potential Defect	Conditions When Maintenance Is Needed	Minimum Performance Standard
Note: table spans multiple pages.			
General	Standing Water	Standing water remains for more than 3 days after the end of a storm.	Conditions corrected per design specifications such that standing water does not remain for more than 3 days following a storm.
	Pests Causing Damage/ Hazards	Nuisance animals causing erosion, damaging plants, or depositing large volumes of feces.	Pests have been addressed by reducing site conditions that they find attractive (e.g. no prolonged water ponding, plantings at proper densities, etc.) and using approved IPM measures.
	Access and Safety Issues	Insufficient egress/ingress routes and fall protection.	Sufficient egress/ ingress routes and fall protection provided per design standards.
Growth Medium	Water Not Permeating	Water permeates slowly or does not permeate growth media (ponds or runs off soil surface) or crusting is observed.	Water permeates growth media per design function.
	Growth Medium Too Thin	Growth medium thickness is less than design thickness (due to erosion and plant uptake).	Growth medium is restored to the design thickness.
	Erosion/ Scouring	Growth media erosion/scour is visible (e.g., gullies).	Eroded/ scoured areas have been repaired per design standards and steps have been taken to prevent further erosion.
	Damage to Erosion Control Measures	Mat or other erosion control is damaged or depleted during plant establishment period.	Erosion control measures repaired/ replaced per design standards and functioning to prevent erosion.
Roof Drain	Reduced Inlet Capacity	Sediment, vegetation, or debris reducing capacity of inlet structure.	Inlet cleaned and functioning at full capacity per design.
	Clogged Pipe	Pipe is clogged.	Pipe is cleared and functioning per design.
	Inlet Pipe Damaged/ Worn	Inlet pipe is in poor condition.	Inlet pipe repaired/ replaced and is functioning per design.
Flashing, Gravel Stops, Utilities, Or Other Structures On Roof	Deterioration of Materials	Flashing, utilities or other structures on roof are deteriorating (can serve as source of metal pollution in vegetated roof runoff).	Deteriorated materials are replaced per design specifications.
Vegetation	Inadequate Plant Coverage	Vegetative coverage falls below 90% (unless design specifications stipulate less than 90% coverage).	At least 90% of planted vegetation is healthy with generally good appearance. Any conditions found that were deleterious to plant health have been corrected where possible.

Stormwater Treatment, Flow Control, and Conveyance Facility Components

Vegetated Roof			
Drainage System Feature	Potential Defect	Conditions When Maintenance Is Needed	Minimum Performance Standard
Note: table spans multiple pages.			
			Routine maintenance schedule, including watering, has been updated as necessary to ensure continued plant health and satisfactory appearance.
	Poor Establishment	Poor plant establishment and possible nutrient deficiency in growth medium.	Growth media amended as needed per specifications to achieve satisfactory plant establishment and growth.
	Vegetation Encroaching Into Border Zone	Vegetation is encroaching into border zone aggregate.	Vegetation has been trimmed or removed per established maintenance practices such that it does not encroach into border zone aggregate (non-vegetated area).
	Noxious Weeds Present	Noxious weeds are present among the site vegetation. Remove, bag, and dispose of Class A & B noxious weeds immediately per WA law. Make reasonable attempts to remove and dispose of Class C noxious weeds. See http://www.nwcb.wa.gov/ . Follow Integrated Pest Management (IPM) protocols.	Noxious weeds are not present on site above thresholds established by state and local law.

Sand Filter Open (Above Ground)

A sand filter functions by filtering stormwater runoff through a sand bed typically 18 inches in depth. The treated runoff is collected in the underdrain system and routed to a detention/retention facility or a downstream conveyance system. A typical sand filtration system consists of a pretreatment system for removing larger sediment and debris from the runoff, a flow spreader, a sand bed, and an underdrain piping. The sand filter bed typically includes a woven (geotextile) fabric between the sand bed and the underdrain system.

An above ground sand filter looks similar to a detention pond with a sand-lined bottom.

Facility objects that are typically associated with an open sand filter include:

- access road or easement
- fence, gate, and water quality sign
- control structure/flow restrictor
- energy dissipaters
- conveyance stormwater pipe

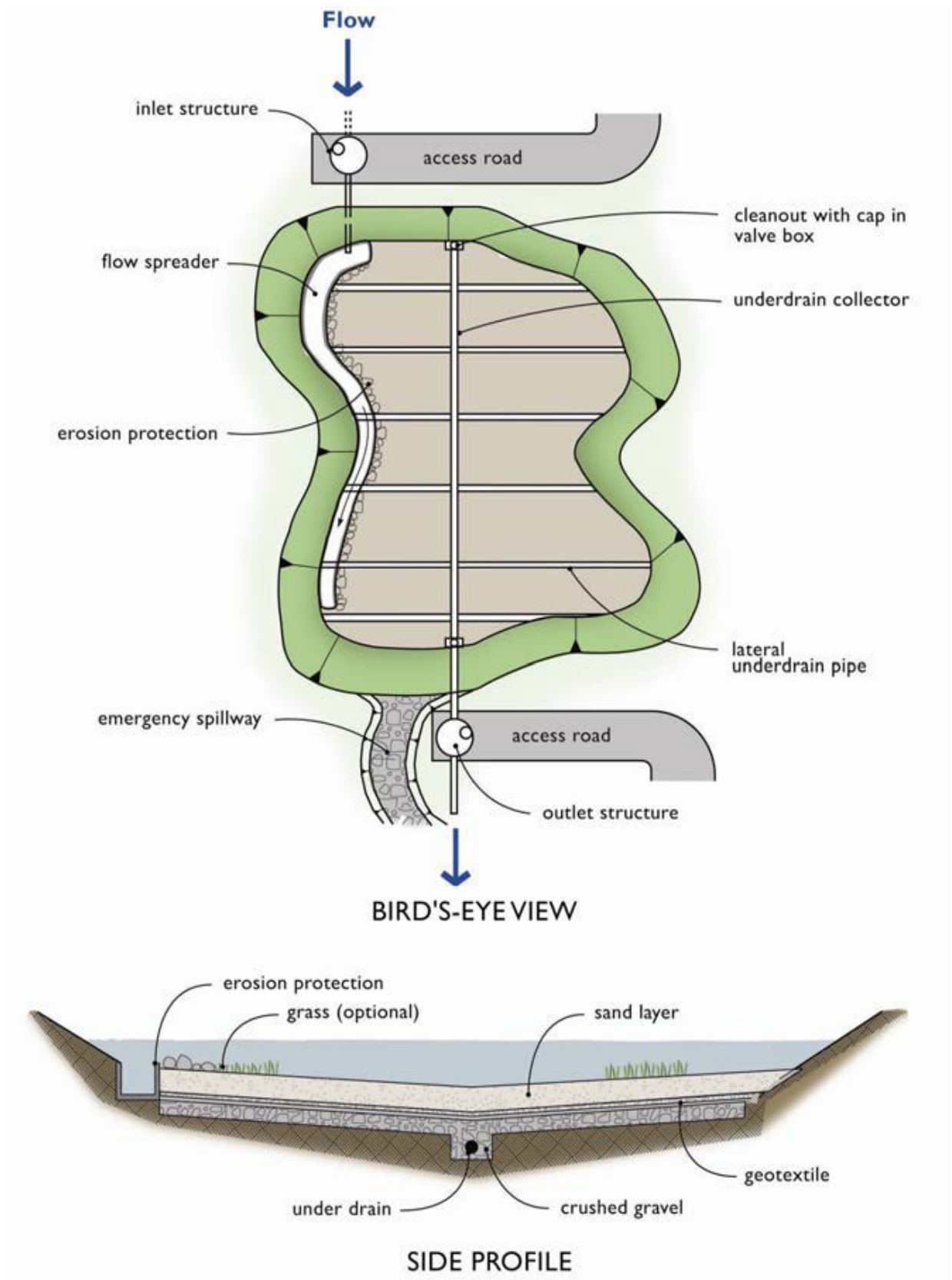

Key Operations and Maintenance Considerations

- Accumulated silt should be scraped off during dry periods with steel rakes or other devices. Once sediment is removed, the design permeability of the filtration media can typically be restored by then striating the surface layer of the media. Finer sediments that have penetrated deeper into the filtration media can reduce the permeability to unacceptable levels, necessitating replacement of some or all of the sand.
- Sand replacement frequency is not well established and will depend on suspended solids levels entering the filter (the effectiveness of the pretreatment BMP can be a significant factor).
- A sand filter should empty in 24 hours following a storm event (24 hours for the pre-settling chamber), depending on pond depth. If the hydraulic conductivity drops to one (1) inch per hour corrective action is needed, e.g.:
 - Scraping the top layer of fine-grain sediment accumulation (mid-winter scraping is suggested)
 - Removal of thatch
 - Aerating the filter surface
 - Tilling the filter surface (late-summer rototilling is suggested)
 - Replacing the top 4 inches of sand
 - Inspecting geotextiles for clogging
- Drawdown tests for the sand bed could be conducted, as needed, during the wet season. These tests can be conducted by allowing the filter to fill (or partially fill) during a storm event, then measuring the decline in water level over a 4-8 hour period. An inlet and an underdrain outlet valve would be necessary to conduct such a test.
- Avoid driving heavy equipment on the filter to prevent compaction and rut formation.

Sand Filter Open (Above Ground)			
Drainage System Feature	Potential Defect	Conditions When Maintenance Is Needed	Minimum Performance Standard
Above Ground (open sand filter)	Sediment Accumulation on Top Layer	Sediment depth exceeds 1/2 inch.	No sediment deposit on grass layer of sand filter that would impede permeability of the filter section.
	Trash and Debris Accumulations	Trash and debris accumulated on sand filter bed.	Trash and debris removed from sand filter bed.
	Sediment/ Debris in Clean-Outs	When the clean-outs become full or partially plugged with sediment and/or debris.	Sediment has been removed from clean-outs.
	Sand Filter Media Clogged	Drawdown of water through the sand filter media takes longer than 24 hours, and/or flow through the overflow pipes occurs frequently.	Top several inches of sand have been replaced and drawdown occurs within 24 hours of a storm event. (May require replacement of entire sand filter depth depending on extent of plugging; a sieve analysis is helpful to determine if the lower sand has too high a proportion of fine material.)
	Prolonged Flows	Sand is saturated for prolonged periods of time (several weeks) and does not dry out between storms due to continuous base flow or prolonged flows from detention facilities.	Low, continuous flows are limited to a small portion of the facility (e.g. by using a low wooden divider or slightly depressed sand surface).
	Short Circuiting	When flows become concentrated over one section of the sand filter rather than dispersed.	Flow and percolation of water through sand filter is uniform and dispersed across the entire filter area.
	Erosion Damage to Slopes	Erosion over 2 inches deep where cause of damage is prevalent or potential for continued erosion is evident.	Slopes have been stabilized using proper erosion control measures.
	Rock Pad Missing or Out of Place	Soil beneath the rock is visible.	Rock pad replaced or rebuilt to design function.
	Flow Spreader	Flow spreader uneven or clogged so that flows are not uniformly distributed across sand filter (may be indicated by rills or gullies on filter surface).	Spreader leveled and cleaned so that flows are spread evenly over sand filter. Rills or gullies not forming on sand filter surface.
	Damaged Pipes	Any part of the piping is crushed or deformed more than 20% or any other failure to the piping.	Pipe repaired or replaced to design specifications.

Sand Filter Vault (Below Ground/Enclosed)

A sand filter vault is similar to an open sand filter except that the sand layer and underdrains are installed below ground in a vault. It consists of presettling and sand filtration cells and functions by filtering stormwater runoff through a sand bed. Treated runoff is collected in the underdrain system and routed to a detention/retention facility or a downstream conveyance system.

Facility objects that are typically associated with a below ground sand filter include:

- access road or easement
- fence, gate, and water quality sign
- conveyance stormwater pipe

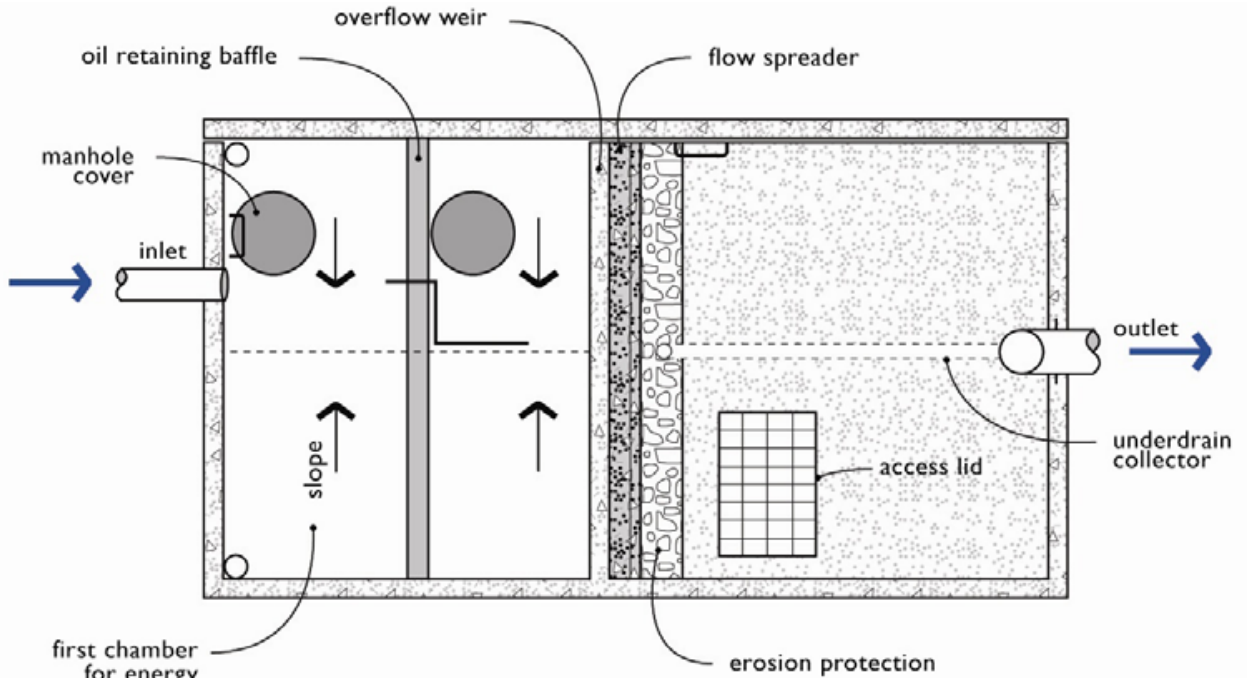

BIRD'S-EYE VIEW

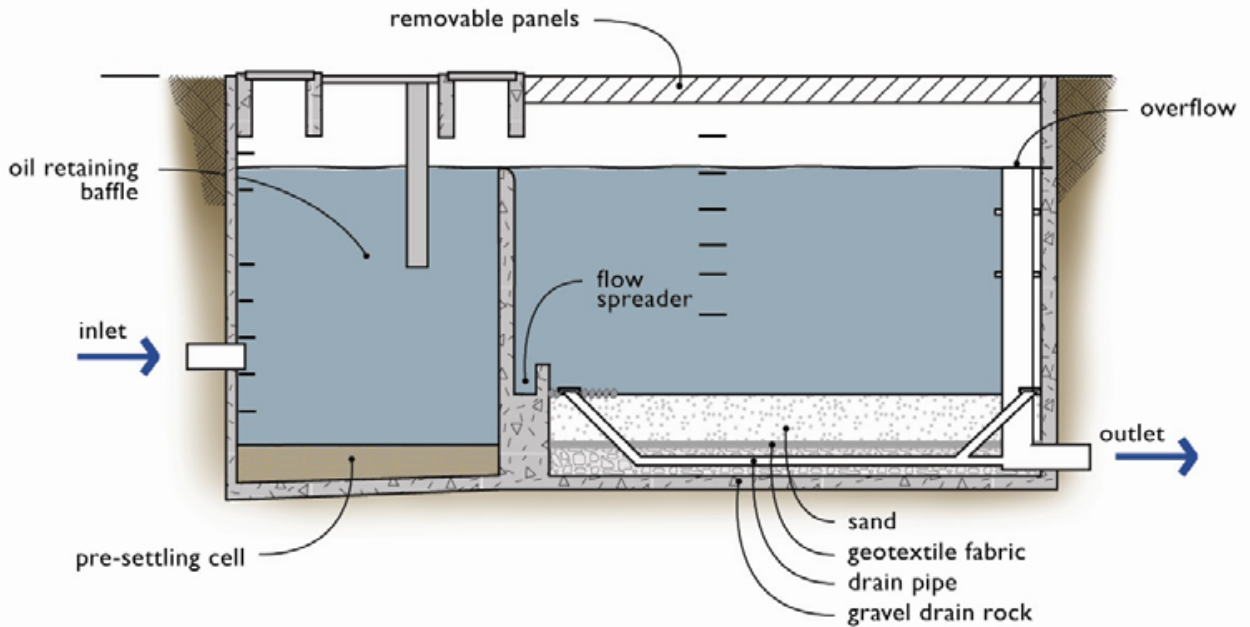

SIDE PROFILE

Key Operations and Maintenance Considerations

- Sand filter vaults are enclosed spaces where harmful chemicals and vapors can accumulate. Therefore, the inspection and maintenance of these facilities should be conducted by an individual trained and certified to work in hazardous confined spaces.
- Sand replacement frequency is not well established and will depend on suspended solids levels entering the filter (the effectiveness of the pretreatment BMP can be a significant factor).
- A sand filter should empty in 24 hours following a storm event (24 hours for the presettling chamber), depending on pond depth. If the hydraulic conductivity drops to one (1) inch per hour corrective action is needed, e.g.:
 - Scraping the top layer of fine-grain sediment accumulation (mid-winter scraping is suggested)
 - Aerating the filter surface
 - Replacing the top 4 inches of sand
 - Inspecting geotextiles for clogging
- Rapid drawdown in the sand bed (greater than 12 inches per hour) indicates short-circuiting of the filter. Inspect the cleanouts on the underdrain pipes and along the base of the embankment for leakage.
- Drawdown tests for the sand bed could be conducted, as needed, during the wet season. These tests can be conducted by allowing the filter to fill (or partially fill) during a storm event, then measuring the decline in water level over a 4 to 8 hour period. An inlet and an underdrain outlet valve would be necessary to conduct such a test.

Sand Filter Vault (Below Ground/Enclosed)			
Drainage System Feature	Potential Defect	Conditions When Maintenance Is Needed	Minimum Performance Standard
Note: table spans multiple pages.			
Below Ground Sand Filter Vault	Sediment Accumulation on Sand Media Section	Sediment depth exceeds 1/2 inch.	No sediment deposits on sand filter section that which would impede permeability of the filter section.
	Sediment Accumulation in Presettling Portion of Vault	Sediment accumulation in vault bottom exceeds the depth of the sediment zone plus 6-inches.	No sediment deposits in first chamber of vault.
	Trash/Debris Accumulation	Trash and debris accumulated in vault, or pipe inlet/outlet, floatables and non-floatables.	Trash and debris have been removed from vault and inlet/outlet piping.
	Sediment in Drain	When drain pipes, cleanouts become full with sediment and/or debris.	Sediment and debris have been removed.

Stormwater Treatment, Flow Control, and Conveyance Facility Components

Sand Filter Vault (Below Ground/Enclosed)			
Drainage System Feature	Potential Defect	Conditions When Maintenance Is Needed	Minimum Performance Standard
Note: table spans multiple pages.			
	Pipes/Cleanouts		
	Short Circuiting	When seepage/flow occurs along the vault walls and corners. Sand eroding near inflow area.	Sand filter media section re-laid and compacted along perimeter of vault to form a semi-seal. Erosion protection added to dissipate force of incoming flow and curtail erosion.
	Damaged Pipes	Inlet or outlet piping damaged or broken and in need of repair.	Pipe repaired and/or replaced.
	Access Cover Damaged/Not Working	Cover cannot be opened, corrosion/deformation of cover. Maintenance person cannot remove cover using normal lifting pressure.	Cover repaired to proper working function or replaced.
	Ventilation Blocked	Ventilation area blocked or plugged.	Blocking material removed or cleared from ventilation area. A specified % of the vault surface area must provide ventilation to the vault interior (see design specifications).
	Vault Structure Damaged; Includes Cracks in Walls, Bottom, Damage to Frame and/or Top Slab.	Cracks wider than 1/2 inch or evidence of soil particles entering the structure through the cracks, or maintenance/inspection personnel determine that the vault is not structurally sound.	Vault replaced or repairs made so that vault meets design specifications and is structurally sound.
		Cracks wider than 1/2 inch at the joint of any inlet/outlet pipe or evidence of soil particles entering through the cracks.	Vault repaired so that no cracks exist wider than 1/4-inch at the joint of the inlet/outlet pipe.
	Defects in Baffles/ Internal Walls	Baffles or walls corroding, cracking, warping and/or showing signs of failure as determined by maintenance/inspection person.	Baffles repaired or replaced to design specifications.
	Access Ladder Damaged	Ladder is corroded or deteriorated, not functioning properly, not securely attached to structure wall, missing rungs, cracks, and misaligned.	Ladder replaced or repaired to design specifications, and is safe to use as determined by inspection personnel.

Infiltration Trench

A stormwater infiltration trench is a closed basin or an open-topped trench built by excavating below existing ground. Infiltration trenches temporarily store stormwater runoff during rain events. Infiltration trenches do not discharge to a downstream conveyance system or nearby surface water. Instead, infiltration trenches rely on the ability of the site's soils to infiltrate the stormwater into the ground.

Facility objects that are typically associated with an infiltration trench include:

- access road or easement
- fence, gate, and water quality sign
- bioswale
- sediment trap
- field inlet
- drywell

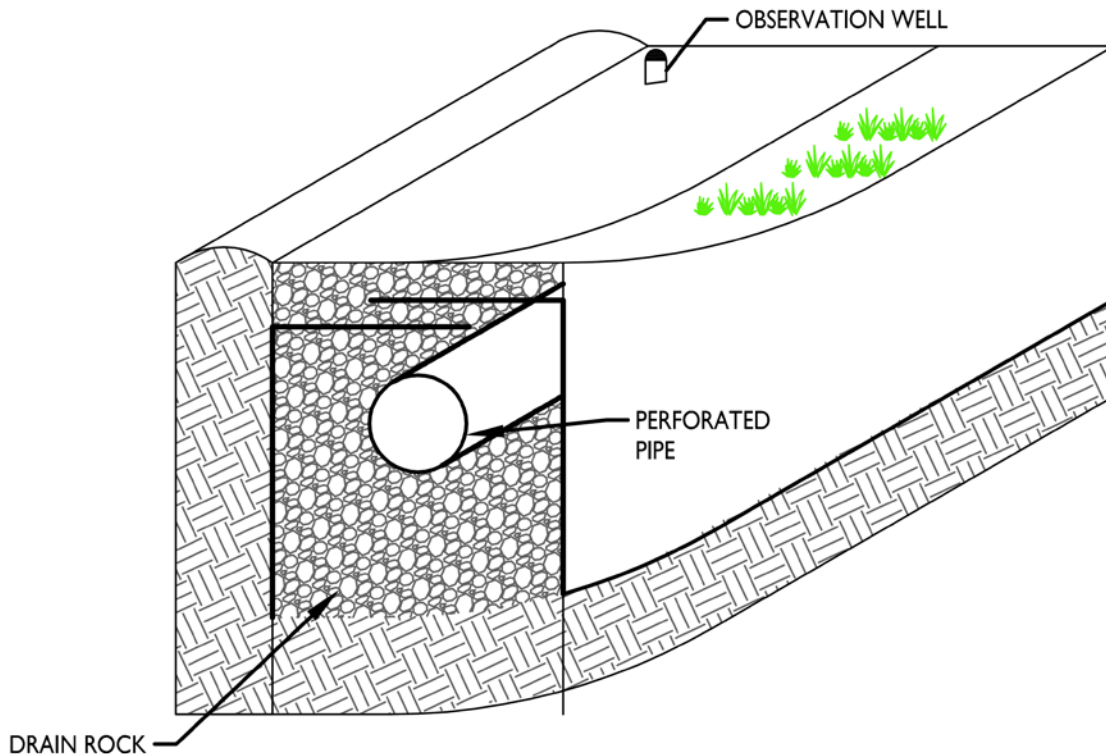

Key Operations and Maintenance Considerations

- Maintenance should be performed as indicated by routine inspections. The principal maintenance objective is to prevent clogging, which may lead to trench failure.
- Infiltration trenches and any pretreatment BMPs should be inspected after large storm events and any accumulated debris or material removed. A more thorough inspection of the trench should be conducted at least annually. Annual inspection should include monitoring the observation well (if one exists) to confirm that the trench is draining within the specified time.
- Monitor sediment buildup in the top foot of stone aggregate or the surface inlet on the same schedule as the observation well.
- Trenches with filter fabric should be inspected for sediment deposits by removing a small section of the top layer. If inspection indicates that the trench is partially or completely clogged, it should be restored to its design condition.
- The most common tools for cleaning infiltration trenches are hand tools to remove built-up sediments and the tops layers of clogged infiltration media from the trench.

Infiltration Trench			
Drainage System Feature	Potential Defect	Conditions When Maintenance Is Needed	Minimum Performance Standard
General	Contaminants and Pollution	Any evidence of oil, gasoline, contaminants or other pollutants. Sheen, obvious oil or other contaminants present. <ul style="list-style-type: none"> • Identify and remove source, AND • Report to Clark County Clean Water Program. 	No contaminants or pollutants present.
	Sediment Depth (via Surface/Observation Well Inspection)	Sediment depth greater than one foot above stone aggregate or the surface inlet.	No sediment in infiltration trench.
	Drainage Slow	Decreased capacity that indicates slow drainage. Does not meet facility design infiltration rate. The Water Quality Design Storm Volume does not infiltrate within 48 hours. Water remains in the trench for greater than 24 hours after the end of most moderate rainfall events.	Perforated drain pipe has been cleaned and drainage rates are per design specifications. (Do not allow removed sediment and water to discharge back into the storm sewer.)

Infiltration Basin

A stormwater infiltration basin disposes of water by holding it in an area where it can soak into the ground. These are open facilities that may either drain rapidly and have grass bases, or have perpetual ponds where water levels rise and fall with stormwater flows. Infiltration facilities may be designed to handle all of the runoff from an area or they may overflow and bypass larger storms. Since the facility is design to pass water into the ground, anything that can cause the base to clog will reduce performance and is a concern. Generally, infiltration basins are managed like detention ponds but with greater emphasis on maintaining the capacity to infiltrate stormwater.

Facility objects that are typically associated with an infiltration facility include:

- access road or easement
- fence, gate, and water quality sign
- energy dissipaters
- conveyance stormwater pipe

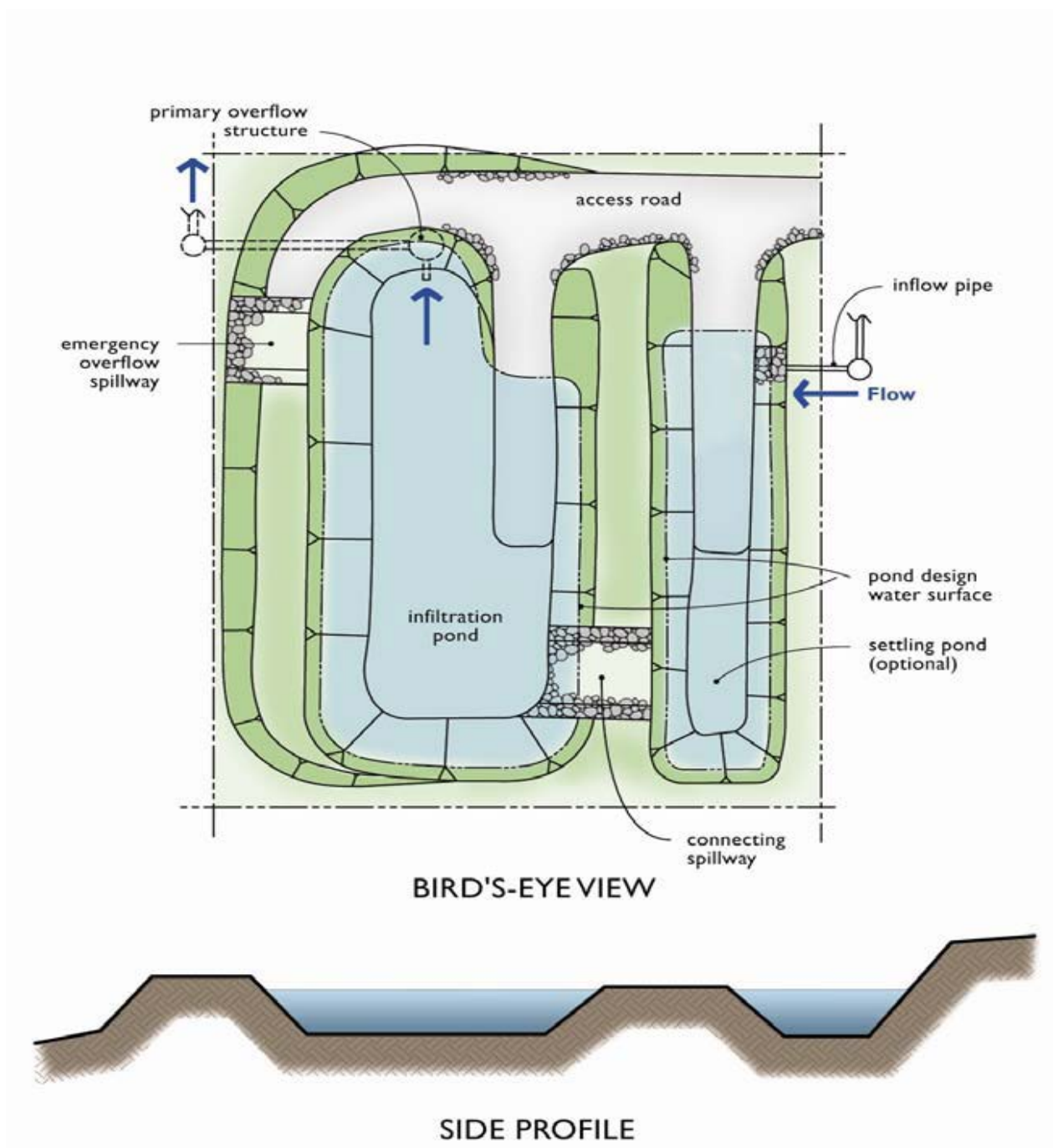

Key Operations and Maintenance Considerations

- Maintenance should be performed per typical schedule and as indicated by routine inspections. The principal maintenance objective is to prevent clogging, which may lead to basin failure.

- Maintain basin floor and side slopes to promote dense turf with extensive root growth. This enhances infiltration, prevents erosion and consequent sedimentation of the basin floor, and prevents invasive weed growth. Immediately stabilize and revegetate bare spots.
- Do not allow vegetation growth to exceed 18 inches in height. Mow the slopes periodically and check for clogging and erosion.
- Use seed mixtures recommended in the table below or functionally similar mixes per the facility's design specifications. The use of slow-growing, stoloniferous grasses will permit long intervals between mowing. Mowing twice a year is generally satisfactory.
- Apply fertilizers only as necessary and in limited amounts to avoid contributing to groundwater pollution. Consult the local agricultural or gardening resources such as Washington State University Extension for appropriate fertilizer type, including slow release fertilizers, and application rates.
- The most common tools for cleaning infiltration basins are hand tools such as rakes and shovels to remove built-up sediments and debris from the surface of the basin.

Plant Material

Table 8: Stormwater Tract "Low Grow" Seed Mix for Infiltration Basin

Stormwater Tract "Low Grow" Seed Mix*		
<u>Botanical Name</u>	<u>Common Name</u>	<u>% By Weight</u>
<i>Festuca arundinacea var.</i>	Dwarf tall fescue	40%
<i>Lolium perenne var. barclay</i>	Dwarf perennial rye** 'Barclay'	30%
<i>Festuca rubra</i>	Red fescue	25%
<i>Agrostis tenuis</i>	Colonial bentgrass	5%
Selected plants shall not include any plants from the State of Washington Noxious Weed List. Refer to clark.wa.gov/weed/ for a current list of noxious weeds.		
*Adapted from Ecology 2012, v.III, Ch 3.2.		
** If wildflowers are used and sowing is done before Labor Day, the amount of dwarf perennial rye can be reduced proportionately to the amount of wildflower seed used.		

Stormwater Treatment, Flow Control, and Conveyance Facility Components

Infiltration Basin			
Drainage System Feature	Potential Defect	Conditions When Maintenance Is Needed	Minimum Performance Standard
Note: table spans multiple pages.			
General	Trash and Debris	Any trash and debris which exceed 1 cubic foot per 1,000 square feet. In general, there should be no visual evidence of dumping. If less than threshold all trash and debris will be removed as part of next scheduled maintenance.	Site is free of trash and debris.
	Poisonous Plants and Noxious Weeds	Any poisonous or nuisance vegetation which may constitute a hazard to maintenance personnel or the public. Any evidence of noxious weeds as defined by State or local regulations. (Apply requirements of adopted IPM policies for the use of herbicides.)	No danger of poisonous vegetation where maintenance personnel or the public might normally be. (Coordinate with Clark County Weed Management department) Complete eradication of noxious weeds may not be possible. Compliance with State or local eradication policies required.
	Contaminants and Pollution	Any evidence of oil, gasoline, contaminants or other pollutants. (Coordinate removal/cleanup with local water quality response agency.)	No contaminants or pollutants present.
	Rodent Holes	Any evidence of rodent holes if facility is acting as a dam or berm, or any evidence of water piping through dam or berm via rodent holes.	Rodents destroyed and dam or berm repaired. (Coordinate with Clark County Maintenance and Operations department; coordinate with Ecology Dam Safety Office if pond exceeds 10 acre-feet.)
Storage Area	Sediment Reducing Infiltration Rate	Water ponding in infiltration pond after rainfall ceases and appropriate time allowed for infiltration. Treatment basins should infiltrate Water Quality Design Storm Volume within 48 hours, and empty within 24 hours after cessation of most rain events. (A percolation test pit or test of facility indicates facility is only working at 90% of its designed capabilities. Test every 2 to 5 years. If two inches or more sediment is present, remove.)	Sediment is removed and/or facility is cleaned so that infiltration system works according design standards.
Filter Bags (If Applicable)	Filled with Sediment and Debris	Sediment and debris fill bag more than 1/2 full.	Filter bag has been replaced or system is redesigned.
Rock Filters	Sediment and Debris	By visual inspection, little or no water flows through filter during heavy rain storms.	Gravel in rock filter is replaced.

Infiltration Basin			
Drainage System Feature	Potential Defect	Conditions When Maintenance Is Needed	Minimum Performance Standard
Note: table spans multiple pages.			
Side Slopes of Pond	Erosion	Eroded damage over 2 inches deep where cause of damage is still present or where there is potential for continued erosion. Any erosion observed on a compacted berm embankment.	Slopes have been stabilized using appropriate erosion control measure(s), e.g., rock reinforcement, planting of grass, compaction. If erosion is occurring on compacted berms a licensed civil engineer should be consulted to resolve source of erosion.
Pond Berms (Dikes)	Settlement	Any part of berm which has settled 4 inches lower than the design elevation.	Dike has been built back to the design elevation.
		If settlement is apparent, measure berm to determine amount of settlement.	
		Settling can be an indication of more severe problems with the berm or outlet works. A licensed civil engineer should be consulted to determine the source of the settlement.	
Emergency Overflow/ Spillway and Berms Over 4 Feet in Height	Tree Growth	Tree growth on emergency spillways creates blockage problems and may cause failure of the berm due to uncontrolled overtopping. Tree growth on berms over 4 feet in height may lead to piping through the berm which could lead to failure of the berm.	Trees removed. If root system is small (base less than 4 inches) the root system may be left in place. Otherwise the roots should be removed and the berm restored. A licensed civil engineer should be consulted for proper berm/spillway restoration.
	Piping	Discernible water flow through pond berm. Ongoing erosion with potential for erosion to continue. (Recommend a Geotechnical engineer be called in to inspect and evaluate condition and recommend repair of condition.)	Piping eliminated. Erosion potential resolved.
Emergency Overflow/ Spillway	Rock Missing	Only one layer of rock exists above native soil in area five square feet or larger, or any exposure of native soil at the top of flow path of spillway. (Rip-rap on inside slopes need not be replaced.)	Rocks and pad depth are restored to design standards.
Emergency Overflow/ Spillway	Erosion	Eroded damage over 2 inches deep where cause of damage is still present or where there is potential for continued erosion. Any erosion observed on a compacted berm embankment.	Slopes have been stabilized using appropriate erosion control measure(s), e.g., rock reinforcement, planting of grass, compaction. If erosion is occurring on compacted berms

Stormwater Treatment, Flow Control, and Conveyance Facility Components

Infiltration Basin			
Drainage System Feature	Potential Defect	Conditions When Maintenance Is Needed	Minimum Performance Standard
Note: table spans multiple pages.			
			a licensed civil engineer should be consulted to resolve source of erosion.
Presettling Ponds and Vaults	Facility or Sump Filled With Sediment and/or Debris	6" or designed sediment trap depth of sediment.	Sediment is removed.

Drywell

A drywell is a perforated, open-bottomed manhole used to infiltrate stormwater into the ground. Drywells temporarily store stormwater runoff during rain events. Drywells do not discharge to a downstream conveyance system or nearby surface water. Instead, drywells rely on the ability of the site's soils to infiltrate the stormwater into the ground.

While not the intended use, drywells trap sediment and some of the oily pollutants in runoff. They are more likely to fill with oily sediment in areas that lack swales or other treatment facilities. Fine soil sediment can clog drywells and lead to localized street flooding. Also, pollutants discharged into drywells can migrate into groundwater. Drywells were often installed in closed topographic depressions, areas with well-drained soils, or areas having inadequate storm sewers. Because drywells can be easily clogged and tend to concentrate pollutants in one place; pollution and sediment control practices should be used to protect them.

Facility objects that are typically associated with a drywell include:

- access road or easement
- fence, gate, and water quality sign
- infiltration trench
- catch basin
- field inlet
- bioswale
- media cartridge filter

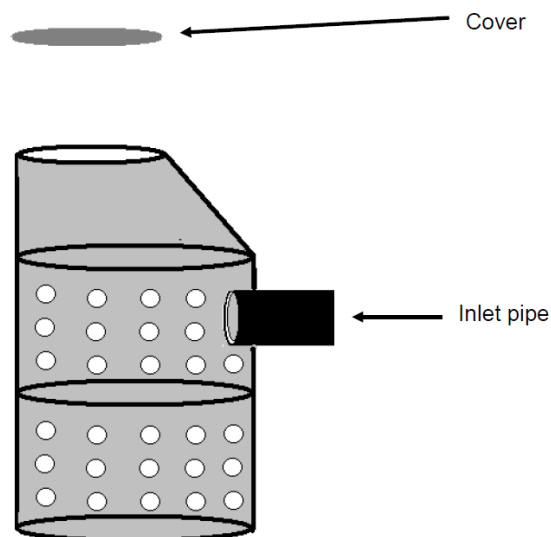



Drywell with Accumulated Trash

Key Operations and Maintenance Considerations

- The most common tool for cleaning drywells is a truck with a tank and vacuum hose (Vactor® truck) to remove sediment and debris from the facility.
- If water remains in a drywell after extended dry periods, that suggests the drywell is in direct contact with groundwater and must be retrofitted to meet state water quality standards and the requirements of the state Underground Injection Control rules. Contact Clark County Environmental Services or the Washington Department of Ecology for more information.

Drywell			
Drainage System Feature	Potential Defect	Conditions When Maintenance Is Needed	Minimum Performance Standard
General	Does Not Dissipate Stormwater	Does not dissipate stormwater.	Replace or repair.
	Opening Clogged	Openings are clogged, reducing capacity.	Openings have been cleared (e.g. by water-jetting); or Convert existing, clogged drywell to a sediment trap and install a new drywell or drainage trench. To convert to a sediment trap, required are grouting holes, covering the base with concrete, and adding piping.
	Standing Water	Standing water indicates the drywell is into the water table.	Rebuild drywell to prevent stormwater from going directly into groundwater.
	Trash and Debris	Trash, debris, or floatables that may exit through pipes.	No trash or debris in drywell.
		Trash or debris in any inlet or outlet pipe.	Inlet and outlet pipes free of trash or debris.
	Sediment	Sediment in drywell exceeds 60 percent of the depth below the inlet pipe.	No sediment in drywell.
	Structure Damage	Maintenance person judges that structure is unsound.	Drywell replaced or repaired to design standards.
Contaminants and Pollution	Any evidence of oil, gasoline, contaminants or other pollutants. <ul style="list-style-type: none"> • Identify and remove source, AND • Report to Clark County Clean Water Program Illicit Discharge and Detection Elimination Program. 	No contaminants or pollutants present.	
Drywell Manhole	Cover Not in Place	Cover is missing or only partially in place. Any open catch basin requires maintenance.	Catch basin cover is closed
	Cover Difficult to Remove	One maintenance person cannot remove lid after applying normal lifting pressure (Intent is to keep cover from sealing off access to maintenance).	Cover can be removed by one maintenance person.
Metal Grates (If Applicable)	Grate opening Unsafe	Grate with opening wider than 7/8 inch.	Grate opening meets design standards.
	Trash and Debris	Trash and debris that is blocking more than 20% of grate surface inletting capacity.	Grate free of trash and debris.
	Damaged or Missing	Grate missing or broken member(s) of the grate.	Grate is in place and meets design standards.

Access Road and Easement

Many stormwater facilities have access roads to bring in heavy equipment for facility maintenance. These roads should be maintained for inspection access and ease of equipment access.

All facilities should allow access for the inspection process.

The easement area should be adequately landscaped. Landscaping is an essential component of stormwater management. Bare soil areas may generate higher levels of stormwater runoff and increase erosion and sedimentation in stormwater facilities. The following checklist gives some general guidance for management.

Access Road/Easement			
Drainage System Feature	Potential Defect	Conditions When Maintenance Is Needed	Minimum Performance Standard
General	Erosion	Soils are bare or eroded.	Erosion repaired and soils have been protected (through seeding/matting/etc).
	Road Surface	Condition of road surface may lead to erosion of the facility or limit access.	Road repaired.
	Erosion of Ground Surface	Noticeable rills are seen in landscaped areas.	Eroded areas are filled, contoured, and seeded. Affected areas regraded as necessary. Steps have been taken to eliminate source of erosion (dispersing flows, energy dissipation, etc.).
	Trash & Debris / Litter	Litter accumulation exceeds 1 cubic foot per 1,000 square feet.	No trash or debris present.
	Poisonous Plants and Noxious weeds	Any poisonous plants or nuisance vegetation which may constitute a hazard to maintenance personnel or the public. Any evidence of noxious weeds as defined by State or local regulations. (Coordinate with Clark County Environmental Services, Vegetation Management program.)	Eradication of Class A weeds as required by State law. Control of Class B weeds designated by Clark County Weed Board. Control of other listed weeds as directed by local policy. Apply requirements of adopted IMP plan for use of herbicides.
	Tree Growth and Hazard Trees	Tree growth does not allow maintenance access or interferes with maintenance activity (i.e., slope mowing, silt removal, vacuuming, or equipment movements). If trees are not interfering with access or maintenance, do not remove. If dead, diseased, or dying trees are identified. (Use a certified Arborist to determine health of tree or removal requirements.)	Trees do not hinder maintenance activities. Harvested trees should be recycled into mulch or other beneficial uses (e.g., alders for firewood).
			Remove hazard trees.
	Trees or shrubs that have been blown down or knocked over.	Vegetation has been replanted if feasible, or replaced.	
	Weeds (Nonpoisonous)	Weeds growing in more than 20% of the landscaped area (trees and shrubs only).	Weeds present in less than 5% of the landscaped area.
	Insects	When insects such as wasps and hornets interfere with maintenance activities.	Insects destroyed or removed from site. Apply insecticides in compliance with adopted Clark County Maintenance and Operations policies.

Fence, Gate, and/or Water Quality Sign

Stormwater facilities such as detention ponds or treatment wetlands often have fences to protect them from damage and keep children away from ponds or hazardous areas. Some facilities are required to have informational signs telling the public that the site is a stormwater facility.

Fence, Gate and/or Water Quality Sign			
Drainage System Feature	Potential Defect	Conditions When Maintenance Is Needed	Minimum Performance Standard
General	Gate or Fence Allows Unauthorized Entry	Openings in fence, missing gate, openings beneath fence allowing unauthorized access.	Gate and/or fence repaired to prevent unauthorized access.
	Locking Mechanism	Mechanism cannot be opened by one maintenance person with proper tools.	Lock repaired/replaced.
		No lock on gate allows unauthorized entry.	Lock replaced.
	Damaged Parts	Posts out of plumb more than six inches.	Post plumb to within 1-1/2 inches of plumb.
		Top rails of plumb more than six inches.	Top rails free of bends greater than 1 inch.
	Erosion	Erosion has resulted in an opening under a fence that allows entry by people or pets.	Soil replaced under fence so that no opening exceeds 4 inches in height.
	Water Quality Sign	Water quality sign is leaning more than 8 inches off vertical.	Sign reset to plumb.
		Water quality sign is missing or 20% of the surface is unreadable.	Sign replaced.

Vegetation

Many stormwater facilities use vegetation as part of the functional design. Vegetation must be maintained to contribute to the function of the facility and to prevent damage to structural elements of the facility (e.g. earthen berms). Another reason to maintain vegetation is aesthetics.

Vegetation maintenance can include trimming, plant replacement, weeding, and pest control. Vegetation maintenance in native vegetation retention areas carries specific requirements.

Objectives for vegetation management in stormwater facilities:

- Maintain healthy plant communities
- Reduce or eliminate sources of pollution related to vegetation care
- Cover bare soil areas with plants
- Control Class A and Class B noxious weeds; control unlisted invasive plants where needed to achieve management objectives
- Tolerance for natural appearance and weeds that do not interfere with facility functions

Key Operations and Maintenance Considerations

- The vegetation management focus is establishing and maintaining healthy low-maintenance native plantings and sustaining the design function of vegetated filters such as biofiltration swales. This includes controlling invasive plants where appropriate, and planting cover on bare soils.
- Use plants appropriate to the facility type, as listed in this manual. In Clark County street Rights of Way, ensure plants used are approved for ROW use by Clark County Public Works.
- In some cases, the original plantings may not be appropriate for the actual condition at a facility. One example is a frequently flooded swale that cannot support normal turf. In cases like this, replace turf with appropriate wetland plants if the underlying drainage problem cannot be fixed.
- Consider the use of soil amendments such as compost before using fertilizer.
- Limit mulch use to covering bare soil while establishing plantings.
- When a chemical control method is chosen, carefully follow the manufacturer's label directions for use. When deciding on and using a chemical control, consider stormwater facilities and drainage systems as leading to water bodies and apply chemicals per the label directions for use over or near water.
- Allow a 5-foot buffer from mature established plantings to fence lines and access roads.
- Within a maintenance easement, select plants that allow for future access and maintenance.

- Trees or shrubs that block access roads may be trimmed (or removed if within the access road) when access is required for maintenance by heavy equipment.
- Trees that pose a risk to stormwater structures due to root growth may be removed and replaced by smaller shrubs.

Use Only Appropriate Plants

Use plants that will thrive in the growing conditions of each facility. Growing conditions are affected by moisture, soil conditions, and light. Plants native to western Washington are preferred. Plant lists for biofiltration swales, bioretention systems, rain gardens, and other facility types are given in the respective BMP maintenance sheets.

Native Vegetation Retention Areas

BMP T5.40 - Preserving Native Vegetation is one of the site design Best Management Practices that may be followed during site development. If this BMP has been used for a site, avoid removing vegetation and trees from the natural growth retention area, except for approved timber harvest activities, the removal of dangerous and diseased trees, and control and removal of noxious weeds. Replace areas cleared of dangerous trees or of noxious weeds with approved native plantings.

Vegetation and Pest Management in Stormwater Facilities

Generally, vegetation should be maintained to blend into surrounding areas. Stormwater facilities can provide habitat for aquatic life and birds. Promoting natural vegetation where feasible improves habitat. Swales often blend into intensively managed landscapes. Pond perimeters can include natural vegetation.

The use of fertilizer is often not compatible with the task of pollutant removal or the direct connection of stormwater facilities to streams and groundwater.

Features of stormwater facility vegetation:

- There is a mix of native and non-native plants
- Generally not used by the public
- Include areas managed to promote design function, such as turf in swales
- Managed landscapes may be nearby
- May be used by fish and wildlife

Integrated Pest Management

Landscape management decisions for controlling unwanted vegetation, diseases, and pests in stormwater facilities should follow Integrated Pest Management principles.

An IPM program might consist of the following steps:

Step 1: Correctly identify problem pests and understand their life cycle.

IPM starts with an understanding of the soil, water, natural resources, and human impacts on site. Identify and research the pest species, including basic physiology and best timing for control. Many pests are a problem during certain seasons or can only be treated in specific phases of the life cycle. Local pest identification help can be obtained from Clark County Weed Board and WSU Extension Master Gardeners, or through online resources such as Washington State Noxious Weed Control Board and Washington Invasive Species Council.

Step 2: Establish tolerance thresholds for pests.

Every landscape has a population of some pest insects, weeds, and diseases. Once the pest has been identified and studied, determine if low levels of the pest are tolerable. Small numbers of certain pests may not be harmful. If this is the case, simply continue to monitor the pest population.

In other cases, the pest may require control. Examples include a pest population that is rapidly increasing in numbers, or an invasive weed that requires control according to state law. Early detection, rapid response (EDRR) plays an important role in the control of pests that are known to be a severe problem in other regions but not yet occurring in ours. In this instance, the tolerance threshold is zero; a quick response to eliminate a future ongoing pest problem is the safest and least expensive control.

Step 3: If pests exceed tolerance thresholds, choose a safe and effective control method.

IPM identifies physical, cultural, biological, and chemical control methods tailored specifically for the pest of concern and the site. Research the available options and choose a control method that is effective. Preferred control methods are economical, low risk to people, and mindful of environmental processes.

Physical control works on a pest directly: digging, hand-pulling, mowing, tilling, trapping, etc.

Cultural control changes the pest's environment: landscape fabric, mulch, soil amendments, altering the irrigation method or duration, crop rotation, crop covers, etc.

Biological control uses natural enemies: beneficial insects, managed grazing, bird boxes and perches, etc.

Chemical control is the use of pesticides: insect bait stations, synthetic and organic foliar herbicides, microbial-based insecticides, oils, soaps, etc.

These control methods should be looked at as tools in a toolbox; IPM selects the right tools for the job at hand. Both short-term control and long-term management is best achieved by using more

than one tool. Often, implementing cultural control methods reduces the amount of physical and chemical control needed.

Step 4: Monitor and evaluate.

Observe and record the results of the control treatment. Evaluate the effectiveness. If necessary, modify maintenance practices to support a healthy landscape and prevent recurrence of the pest.

IPM emphasizes that pest control is not a one-time proposition; the pest control process should be viewed as a cycle that rotates through planning, control, and evaluation. As pest issues change over time, the IPM plan adapts.

- Proper planning and management decisions begin the IPM process. All control methods are considered during the information-gathering and planning process. Often a combination of methods is best.
- Cultural methods of vegetation and pest control are preferred.
- Mechanical means of vegetation and pest control are next in line of preference, and are utilized where appropriate.
- Biological methods of vegetation and pest control are considered before chemical means, where they are appropriate.
- Botanical and synthetic pesticides are used in an appropriate manner when other control methods are deemed ineffective or not cost-efficient.

This page intentionally left blank.

On-site Stormwater Management

The BMPs in this section are generally located on residential sites and landscaped areas. This section does not include maintenance criteria for all types of on-site stormwater management BMPs because some are also considered treatment and flow control facilities, and therefore are described in the previous section, and others will be rare or absent in Clark County.

Downspout Infiltration

Roof downspout infiltration systems are simple pre-engineered designs for infiltrating roof runoff in residential yards.

Facility objects that are typically associated with downspout infiltration include:

- Downspout drywell
- Downspout infiltration trench

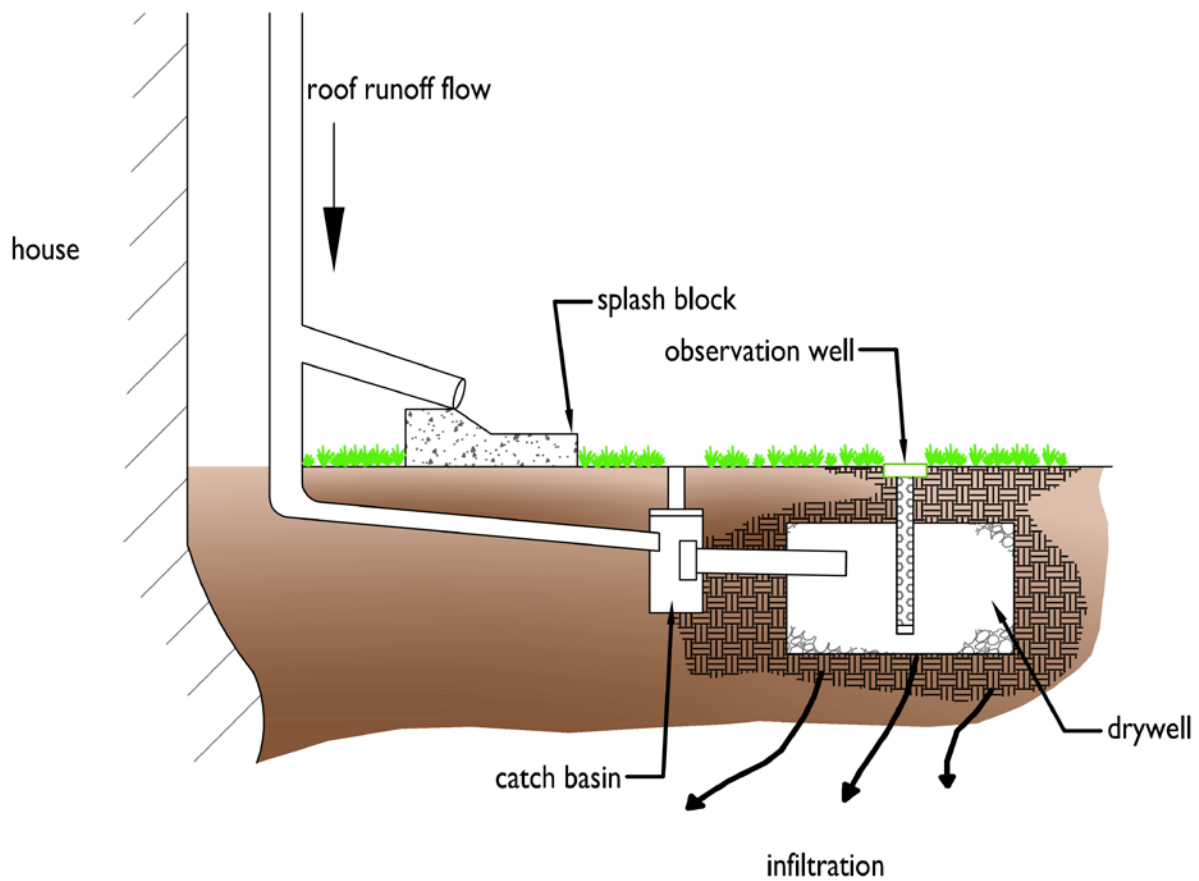

Downspout Drywell

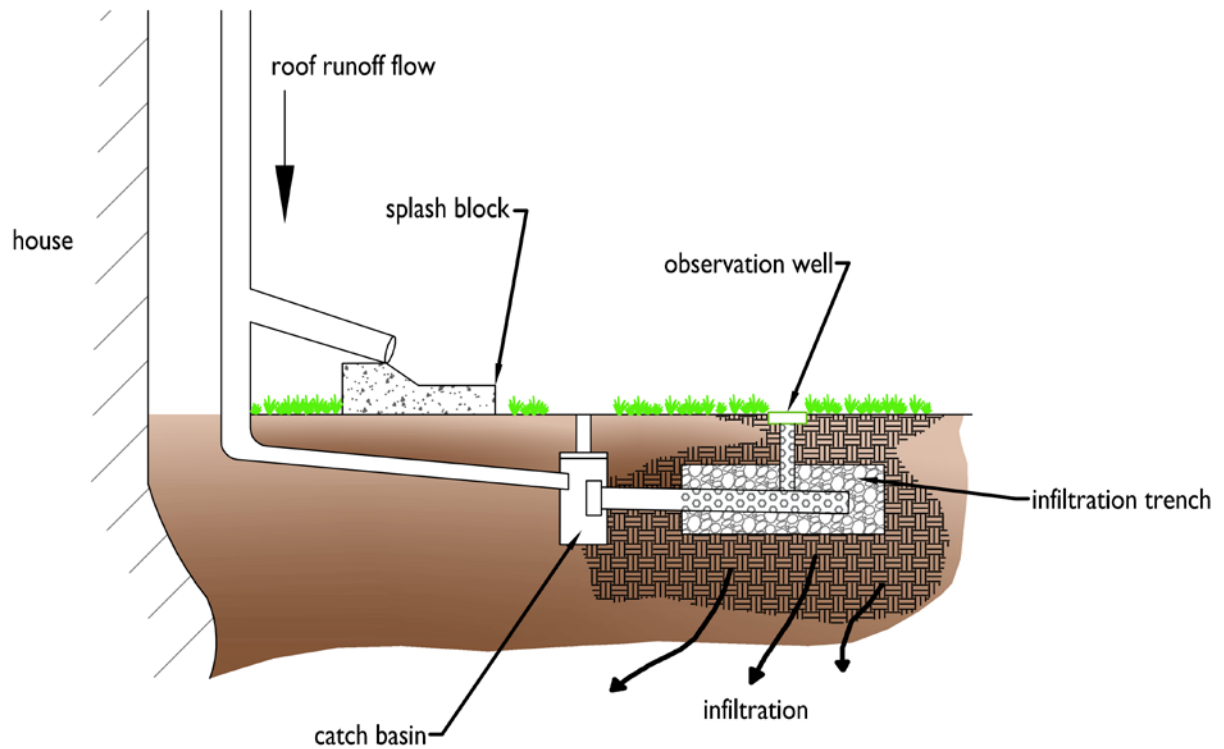

Downspout Infiltration Trench

Key Operations and Maintenance Considerations

- Keep gutters free of debris and sediment or use a downspout insert to prevent debris or sediment from entering the downspout from the gutter while still allowing water to pass into the downspout.
- The most common tool for cleaning these systems is a hose to flush downspouts.

Downspout Infiltration			
Drainage System Feature	Potential Defect	Conditions When Maintenance Is Needed	Minimum Performance Standard
Infiltration Trench	Drainage Slow	Decreased capacity that indicates slow drainage.	Perforated drain pipe has been cleaned and drainage rates are per design specifications. (Do not allow removed sediment and water to discharge back into the storm sewer.)
	Damage to or Trash/Sediment Accumulation Around Pipes	Accumulation of trash, debris, or sediment in roof drains and gutters. Pipe from sump to trench has accumulated sediment or is plugged. Cracked, collapsed, broken, or misaligned drain pipes.	Trash, debris, and sediment is cleared from dispersion trench components (gutters, pipes, etc.). Pipes are free of damage or defects that hinder system from functioning according to design.
Downspout Drywell	Drainage Slow	Decreased capacity that indicates slow drainage. Does not meet facility design infiltration rate.	Drywell has been cleaned and drainage rates are per design specifications. (Do not allow removed sediment and water to discharge back into the storm sewer.)
	Standing Water	Standing water indicates the drywell is into the water table.	Rebuild drywell to prevent stormwater from going directly into groundwater.
	Sediment	Sediment in drywell exceeds 60 percent of the depth below the inlet pipe.	No sediment in drywell.

Downspout Dispersion

Downspout dispersion systems consist of splash blocks or gravel-filled trenches, which serve to spread roof runoff over vegetated pervious areas.

Facility objects that are typically associated with downspout dispersion include:

- Splash block
- Downspout extension
- Dispersion trench: Gravel-filled trenches used to spread stormwater runoff from a downspout drain over a vegetated pervious area. Downspout drains are routed to a trench via a perforated or slotted pipe. The trench typically includes a notched grade board or other device to distribute flow equally along the length of the trench.
- Dispersal area: Stormwater is dispersed to an area vegetated with well-established lawn or pasture, landscaping with well-established groundcover, or native vegetation with natural groundcover. The required vegetated flow path is 50 feet for splash blocks and concentrated dispersion, 25 feet when using a dispersion trench and varies for sheet flow dispersion.

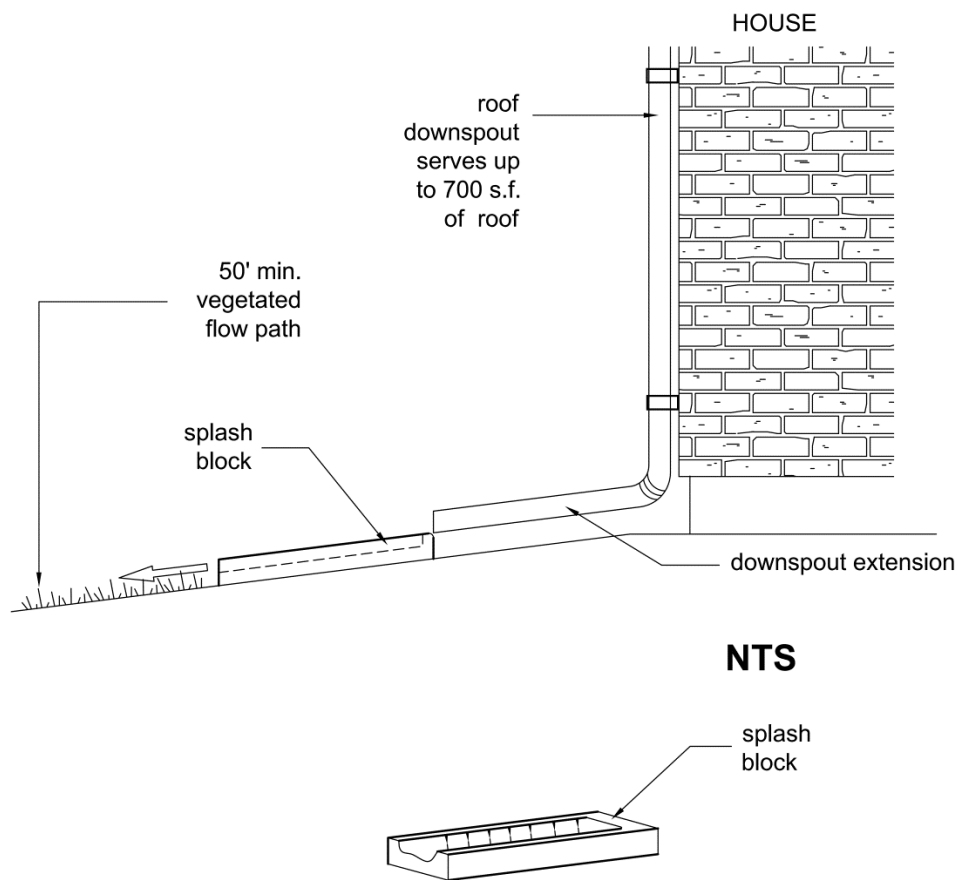

Downspout Dispersion using Splash Blocks

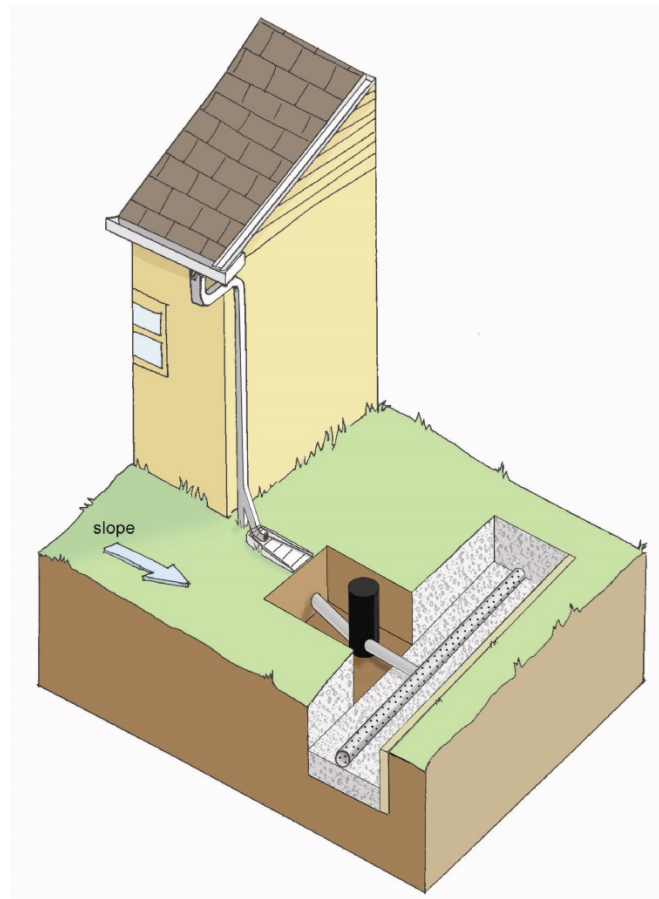

Schematic Downspout Dispersion using Dispersion Trench

Key Operations and Maintenance Considerations

- For dispersion practices to be effective, the dispersion area must remain covered with dense, well-established vegetation. Site uses should protect vegetation and avoid compaction.
- A notched grade board at a dispersion trench must be maintained at a level grade to prevent concentrated flow. Downspout drains are directed to the trench via a storage sump that must be maintained to remove accumulated sediment.
- The groundcover for the extent of the flow in any dispersal area must be maintained to be dense enough to help disperse and infiltrate flows and to prevent erosion.
- The most common tools for cleaning these systems are hand tools to redistribute material disturbed by concentrated flows and a hose to flush downspouts.

Downspout Dispersion			
Drainage System Feature	Potential Defect	Conditions When Maintenance Is Needed	Minimum Performance Standard
Note: table spans multiple pages.			
General	Pests	Signs of pest infestations (IPM protocol threshold(s) are exceeded), including rodent holes or mounds that disturb dispersion flow paths.	Pests are not present or engaged in activities that present a significant public health risk or compromise to the intended design function of the facility. Pests that have exceeded acceptable thresholds have been addressed using appropriate IPM measures.
Splash Block	Water Directed Towards Building	Water is being directed towards building structure.	Water is directed away from foundations and other building structures.
	Erosion	Water disrupts soil media.	Water is dispersed into soil/mulch/plantings in a manner that does not create erosion or other issues due to concentrated flows.
Dispersion Trench	Concentrated Discharge	Visual evidence of water discharging at concentrated points along trench (normal condition is a "sheet flow" from edge of trench; intent is to prevent erosion damage).	Water is discharging as a sheet flow and any disruptive material (e.g. trash, debris, sediment accumulation) has been removed from trench surface.
	Surface of Trench	Accumulated trash, debris, or sediment on drain rock surface impedes sheet flow from facility. Vegetation/moss present on drain rock surface impedes sheet flow from facility.	Surface of drain rock is free of trash, debris, and sediment accumulation. Rock surface is open, free of vegetation buildup, and drains freely.
	Damage to or Trash/Sediment Accumulation Around Pipes	Accumulation of trash, debris, or sediment in roof drains, gutters, driveway drains, area drains, etc. Pipe from sump to trench or drywell has accumulated sediment or is plugged. Cracked, collapsed, broken, or misaligned drain pipes.	Trash, debris, and sediment is cleared from dispersion trench components (gutters, pipes, etc.). Pipes are free of damage or defects that hinder system from functioning according to design.
Storage Sump	Sediment in Sump	Sediment in the sump.	Sediment not present in sump. Sediment has also been removed from adjacent components (inlet/outlet pipes, etc.) to prevent immediate re-accumulation.
	Access Lid Not Working	Cannot be easily opened; buried; or cover missing.	Access lid present and functioning per design standards.
	Erosion	Erosion of the pond's side slopes and/or scouring of the pond bottom, which exceeds 6-inches, or where continued erosion is prevalent.	Slopes stabilized using proper erosion control measures and repair methods.
Rock Pad	General	Only one layer of rock exists above native soil in area 6 square feet or larger, or any exposure of native soil. Soil erosion in or adjacent to rock pad.	Rock pad has been repaired or replaced to meet design standards.

Downspout Dispersion			
Drainage System Feature	Potential Defect	Conditions When Maintenance Is Needed	Minimum Performance Standard
Note: table spans multiple pages.			
Dispersal Area	Erosion or Sediment Accumulation	Erosion (gullies/ rills) greater than 2 inches deep in dispersal area. Accumulated sediment or debris to extent that blocks or channelizes flow path.	Cause of erosion has been eliminated and the damaged area has been repaired and stabilized.
	Standing Water After Storm Event	Standing surface water in dispersion area remains for more than 3 days after the end of a storm event.	Standing water drains within 72 hours of a storm event.
	Transition Zone Erosion and Sizing	Adjacent soil erosion; uneven surface creating concentrated flow discharge; or less than two feet of width.	Transition zone meets design criteria and does not exhibit erosion or other evidence of concentrated flows.
	Poor Vegetation Cover	Poor vegetation cover such that erosion is occurring.	Vegetation has been properly watered and established to meet facility design specifications.
	Excessive Vegetation Cover	Vegetation inhibits dispersed flow along flow path.	Vegetation has been weeded, trimmed, pruned, or thinned to meet facility design criteria.

Sheet Flow and Concentrated Flow Dispersion

Dispersion attenuates peak flows by slowing the runoff entering into the conveyance system, allowing some infiltration, and providing some water quality benefits. The following two types of dispersion systems are covered in this section:

- Sheet flow dispersion systems: Sheet flow dispersion is the simplest method of runoff control. This BMP can be used for any impervious or pervious surface that is graded to avoid concentrating flows. Because flows are already dispersed as they leave the surface, they need only traverse a narrow band of adjacent vegetation for effective attenuation and treatment.
- Concentrated dispersion systems: Dispersion of concentrated flows from driveways or other pavement through a vegetated pervious area.

Facility objects that are typically associated with sheet flow and concentrated dispersion include:

- Transition zone (sheet flow dispersion): A 2-foot-wide transition zone is typically included to discourage channeling between the edge of the impervious surface (or building eaves) and the downslope vegetation. This transition zone may consist of an extension of subgrade material (crushed rock), modular pavement, drain rock, or other material.
- Rock pad at discharge point (concentrated flow dispersion): A rock pad must be maintained to provide energy dissipation and initial dispersion at any point that a concentrated flow enters a dispersion area.
- Dispersal area: Stormwater is dispersed to an area vegetated with well-established lawn or pasture, landscaping with well-established groundcover, or native vegetation with natural groundcover. The required vegetated flow path is 50 feet for splash blocks and concentrated dispersion, 25 feet when using a dispersion trench and varies for sheet flow dispersion.

Key Operations and Maintenance Considerations

- For dispersion practices to be effective, the dispersion area must remain covered with dense, well-established vegetation. Site uses should protect vegetation and avoid compaction.
- The groundcover for the extent of the flow in any dispersal area must be maintained to be dense enough to help disperse and infiltrate flows and to prevent erosion.
- The most common tools for cleaning these systems are hand tools to redistribute material disturbed by concentrated flows.

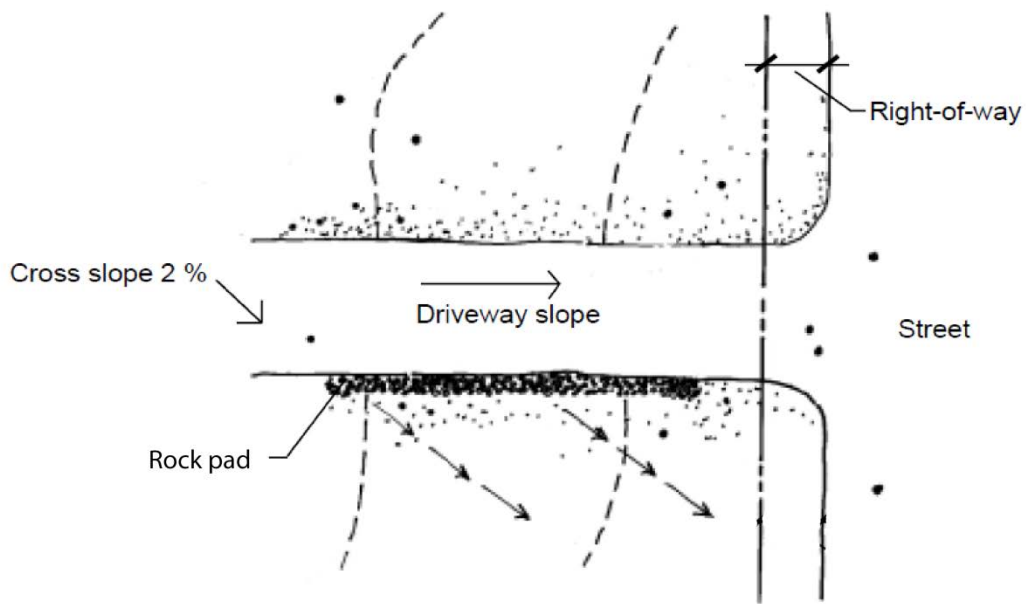

Sheet Flow Dispersion

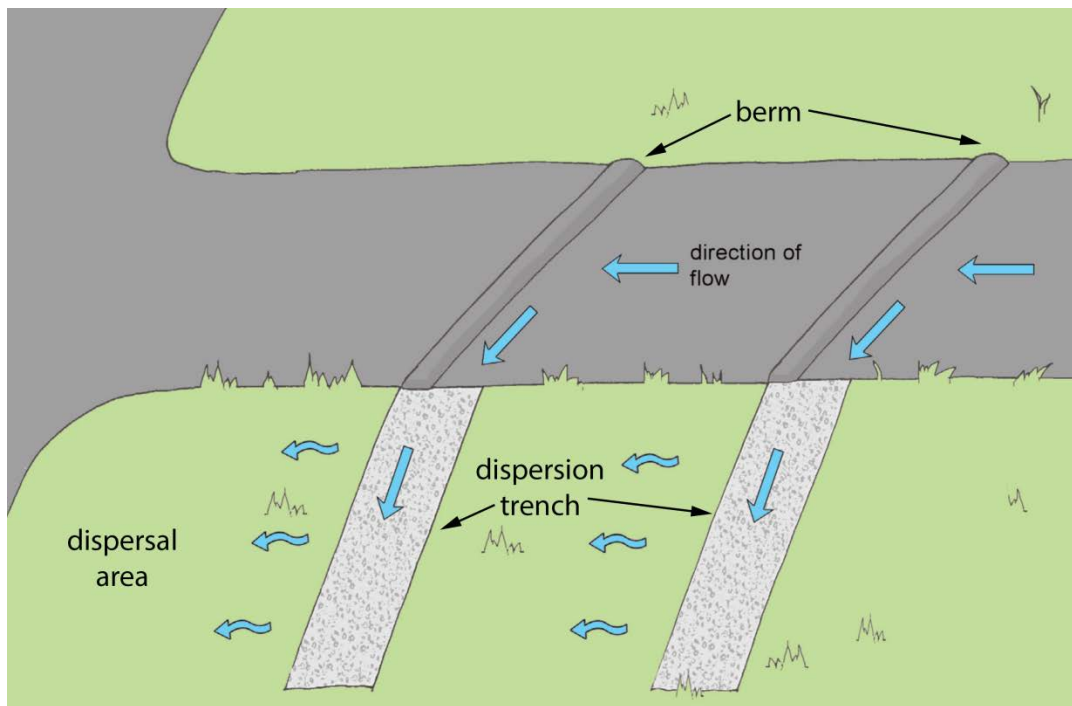

Concentrated Flow Dispersion

Sheet Flow and Concentrated Flow Dispersion			
Drainage System Feature	Potential Defect	Conditions When Maintenance Is Needed	Minimum Performance Standard
General	Pests	Signs of pest infestations (IPM protocol threshold(s) are exceeded), including rodent holes or mounds that disturb dispersion flow paths.	Pests are not present or engaged in activities that present a significant public health risk or compromise to the intended design function of the facility. Pests that have exceeded acceptable thresholds have been addressed using appropriate IPM measures.
Dispersion Trench	Concentrated Discharge	Visual evidence of water discharging at concentrated points along trench (normal condition is a "sheet flow" from edge of trench; intent is to prevent erosion damage).	Water is discharging as a sheet flow and any disruptive material (e.g. trash, debris, sediment accumulation) has been removed from trench surface.
	Surface of Trench	Accumulated trash, debris, or sediment on drain rock surface impedes sheet flow from facility. Vegetation/moss present on drain rock surface impedes sheet flow from facility.	Surface of drain rock is free of trash, debris, and sediment accumulation. Rock surface is open, free of vegetation buildup, and drains freely.
	Damage to or Trash/Sediment Accumulation Around Pipes	Accumulation of trash, debris, or sediment in driveway drains and area drains, etc. Pipe from sump to trench has accumulated sediment or is plugged. Cracked, collapsed, broken, or misaligned drain pipes.	Trash, debris, and sediment is cleared from dispersion trench components. Pipes are free of damage or defects that hinder system from functioning according to design.
Rock Pad	General	Only one layer of rock exists above native soil in area 6 square feet or larger, or any exposure of native soil. Soil erosion in or adjacent to rock pad.	Rock pad has been repaired or replaced to meet design standards.
Dispersal Area	Erosion or Sediment Accumulation	Erosion (gullies/ rills) greater than 2 inches deep in dispersal area. Accumulated sediment or debris to extent that blocks or channelizes flow path.	Cause of erosion has been eliminated and the damaged area has been repaired and stabilized.
	Standing Water After Storm Event	Standing surface water in dispersal area remains for more than 3 days after the end of a storm event.	Standing water drains within 72 hours of a storm event.
	Transition Zone Erosion and Sizing	Adjacent soil erosion; uneven surface creating concentrated flow discharge; or less than two feet of width.	Transition zone meets design criteria and does not exhibit erosion or other evidence of concentrated flows.
	Poor Vegetation Cover	Poor vegetation cover such that erosion is occurring.	Vegetation has been properly watered and established to meet facility design specifications.
	Excessive Vegetation Cover	Vegetation inhibits dispersed flow along flow path.	Vegetation has been weeded, trimmed, pruned, or thinned to meet facility design criteria.

Compost-Amended Soil

Naturally occurring (undisturbed) soil and vegetation provide important stormwater functions including: water infiltration; nutrient, sediment, and pollutant adsorption; sediment and pollutant biofiltration; water interflow storage and transmission; and pollutant decomposition.

Compaction from construction can reduce the soil's natural ability to provide these functions. Compost-amended soils are intended to replace these lost functions by establishing a minimum soil quality and depth in the post-development landscape.

Sufficient organic content is a key to soil quality. Soil organic matter can be attained through numerous amendments such as compost, composted woody material, biosolids, and forest product residuals. The full benefits of compost-amended soils are realized when desired soil media depths are maintained and soil compaction is minimized.

Key Operations and Maintenance Considerations

- Replenish soil media as needed (as a result of erosion) and address compacted, poorly draining soils.
- Site uses should protect vegetation and avoid soil compaction. Care should be taken to prevent compaction of soils via vehicular loads and/or excessive foot traffic, especially during wet conditions.
- The table below provides the recommended maintenance frequencies, standards, and procedures for compost-amended soils. The level of routine maintenance required and the frequency of corrective maintenance actions may increase for facilities prone to erosion due to site conditions such as steep slopes or topography tending to concentrate flows.

Compost-Amended Soil			
Drainage System Feature	Potential Defect	Conditions When Maintenance Is Needed	Minimum Performance Standard
Soil Media	Soils Waterlogged or Not Infiltrating	Soils become waterlogged, or otherwise do not appear to be infiltrating.	Soils have been aerated or amended such that infiltration occurs and soils do not remain completely saturated, per design specifications.
	Erosion/Scouring	Areas of potential erosion are visible, such as gullies or scouring.	Any eroded areas have been repaired, and sources of erosion addressed to prevent further soil erosion.
Vegetation	Vegetation in Poor Health	Less than 75% of planted vegetation is healthy with a generally good appearance.	At least 75% of planted vegetation is healthy with generally good appearance. Any conditions found that were deleterious to plant health have been corrected where possible. Routine maintenance schedule has been updated as necessary to ensure continued plant health and satisfactory appearance.
	Poisonous Plants and Noxious Weeds	Any poisonous plants or nuisance vegetation which may constitute a hazard to maintenance personnel or the public. Any evidence of noxious weeds as defined by State or local regulations. (Coordinate with Clark County Environmental Services Department, Vegetation Management Program.)	No danger of poisonous vegetation where maintenance personnel or the public might normally be. Eradication of Class A weeds as required by State law. Control of Class B weeds designated by Clark County Weed Board. Control of other listed weeds as directed by local policies. Apply requirements of adopted IPM policy for the use of herbicides.
	Other Weeds Present	Other weeds (not listed on County/State noxious weed lists) are present on site.	Weeds have been removed per the routine maintenance schedule, following IPM protocols.

Rain Garden

Rain gardens are non-engineered, shallow, landscaped depressions with compost-amended soils and adapted plants. The depression temporarily stores stormwater runoff from adjacent areas. Some or all of the influent stormwater passes through the amended soil profile and into the underlying native soil. Stormwater that exceeds the storage capacity is designed to overflow to an adjacent drainage system.

The main components of rain gardens (and the associated maintenance considerations) are very similar to those listed for bioretention facilities. However, rain gardens do not require an engineered soil mix (native soils may be amended) and usually do not have underdrains or other control structures.

Signage can also be used to identify the vegetated area as a stormwater BMP and inform maintenance crews and the general public about protecting the rain garden's function (e.g., no walking in the garden).

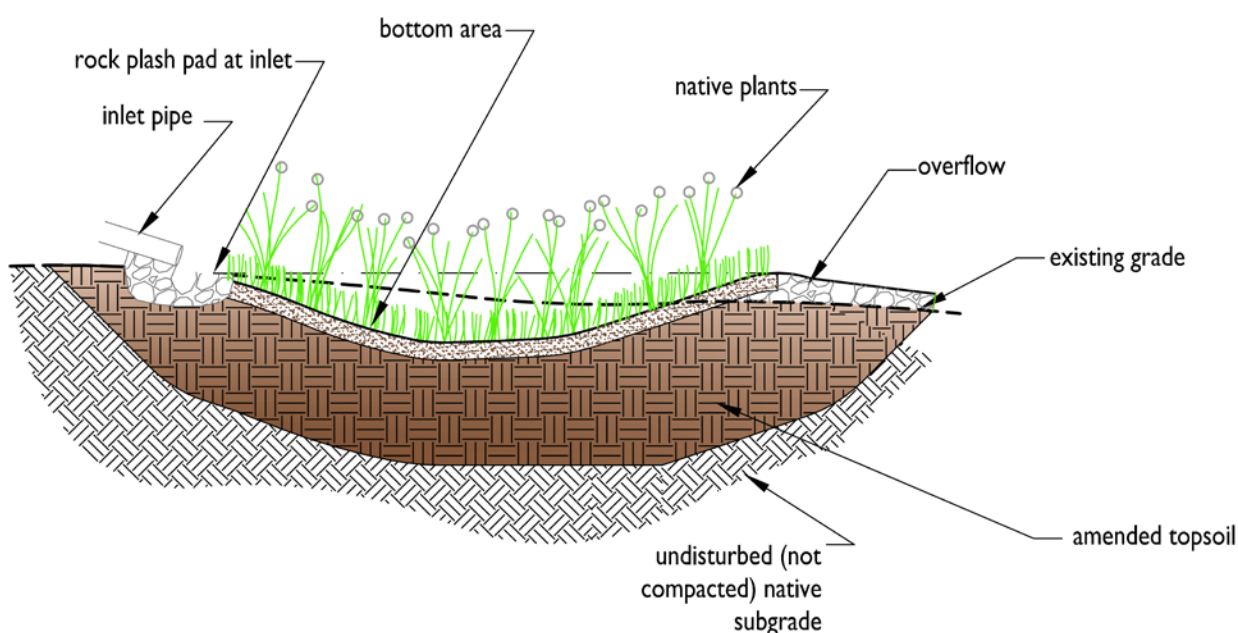

Source: Redrawn from Oregon State University Extension LID 1.06 Infiltration Rain Garden with Planting Soil

Key Operations and Maintenance Considerations

- Fertilizer use should be avoided in rain gardens, particularly those located in watersheds draining to phosphorous-sensitive water bodies.
- Inspect any inlets and pipes which are part of the rain garden at least annually and clean out any debris which might be blocking inlets or pipe structures.

- Rain gardens must be protected from foot traffic, vehicles and other loads, particularly during wet conditions, to prevent compaction of the amended soil and preserve infiltration capacity.
- The most common tools for maintenance of rain gardens are hand tools to remove built up sediment and debris in the garden, to redistribute media displaced, and to prune plants as required.

Plant Material

Table 9: Plant List for Bioretention System and Rain Garden*

Moist to Wet Soil Conditions (Facility Bottom to Bottom of Overflow)			Table continues next page	
Type	Botanical Name	Common Name	O.C. Spacing	Allowed ROW**
Herbaceous	<i>Carex densa</i>	Dense sedge	12"	Y
Herbaceous	<i>Carex morrowii</i>	Ice Dance	12"	Y
Herbaceous	<i>Carex obnupta</i>	Slough Sedge	12"	N
Herbaceous	<i>Deschampsia cespitosa</i>	Tufted Hair Grass	12"	N
Herbaceous	<i>Juncus patens</i>	Spreading Rush	12"	Y
Shrub	<i>Cornus sericea 'Kelseyii'</i>	Kelsey Dogwood	24"	Y
Shrub	<i>Spiraea betulifolia</i>	Birchleaf Spiraea	24"	N
Shrub	<i>Spiraea densiflora</i>	Sub-alpine Spiraea	24"	Y
Shrub	<i>Spiraea japonica</i>	Japanese spirea cultivars	24"	Y
Groundcover	<i>Rubus calcynoides & pentalobus</i>	Creeping Bramble	12"	N
Accent	<i>Camassia leichtinii</i>	Great Camas	12"	N
Accent	<i>Camassia quamash</i>	Common Camas	12"	N
Tree	<i>Acer campestre 'Evelyn'</i>	Elizabeth Hedge Maple	30'	Y
Tree	<i>Betula jacquemontii</i>	Jacquemontii Birch	60'	N
Tree	<i>Celtis occidentalis</i>	Hackberry	50'	N
Tree	<i>Koelreuteria paniculata</i>	Goldenrain Tree	30'	Y
Tree	<i>Nyssa sylvatica</i>	Black tupelo	50'	Y
Tree	<i>Prunus virginiana 'Canada Red'</i>	Canada Red Chokecherry	25'	Y
Tree	<i>Quercus shumardii</i>	Shumard Oak	70'	Y
Tree	<i>Rhamnus purshiana</i>	Cascara	30'	N
Dry Soil Conditions (Overflow and Above)				
Type	Botanical Name	Common Name	O.C. Spacing	Allowed ROW
Herbaceous	<i>Deschampsia cespitosa</i>	Tufted Hair Grass	12"	N
Herbaceous	<i>Helictotrichon sempervirens</i>	Blue Oat Grass	12"	Y
Shrub	<i>Cornus sericea 'Kelseyii'</i>	Kelsey Dogwood	24"	Y
Shrub	<i>Euonymous japonicas 'Microphyllus'</i>	Boxleaf Evergreen	24"	Y
Shrub	<i>Mahonia aquifolium 'Compacta'</i>	Oregon Grape	24"	Y
Shrub	<i>Spiraea betulifolia</i>	Birchleaf Spiraea	24"	N

Shrub	<i>Spiraea densiflora</i>	Sub-alpine Spiraea	24"	Y
Shrub	<i>Spiraea japonica</i>	Japanese spirea cultivars	24"	Y
Groundcover	<i>Arctostaphylos uva-ursi</i>	Kinnickinnick	12"	Y
Groundcover	<i>Fragaria chiloensis</i>	Coastal Strawberry	12"	Y
Groundcover	<i>Mahonia repens</i>	Creeping Oregon Grape	12"	N
Accent	<i>Camassia leichtinii</i>	Great Camas	12"	N
Accent	<i>Camassia quamash</i>	Common Camas	12"	N
Accent	<i>Iris douglasiana</i>	Douglas Iris	12"	N
Accent	<i>Iris tenax</i>	Oregon Iris	12"	N
Tree	<i>Acer campestre</i> 'Evelyn'	Elizabeth Hedge Maple	30'	Y
Tree	<i>Betula jacquemontii</i>	Jacquemontii Birch	60'	N
Tree	<i>Celtis occidentalis</i>	Hackberry	50'	N
Tree	<i>Koelreuteria paniculata</i>	Goldenrain Tree	30'	Y
Tree	<i>Prunus virginiana</i> 'Canada Red'	Canada Red Chokecherry	25'	Y
Tree	<i>Quercus shumardii</i>	Shumard Oak	70'	Y
Tree	<i>Rhamnus purshiana</i>	Cascara	30'	N
Selected plants shall not include any plants from the State of Washington Noxious Weed List. Refer to clark.wa.gov/weed/ for a current list of noxious weeds.				
*Adapted from Portland Bureau of Environmental Services <i>2014 Stormwater Management Manual</i> , Appendix F.4., Planting Templates and Plant Lists				
** Plant species allowed in Clark County street Rights of Way				

Rain Garden			
Drainage System Feature	Potential Defect	Conditions When Maintenance Is Needed	Minimum Performance Standard
General	Trash and Debris	Trash or debris present in rain garden.	Rain garden is free of trash or debris.
Side Slopes	Erosion on Slopes	Side slopes or other areas of the rain garden exhibit signs of erosion (gullies, channels, fine soils washed away, etc.).	Any eroded areas have been repaired/replanted per design, and sources of erosion addressed to prevent further soil erosion.
	Rockery Side Walls Insecure	Rockery side walls are insecure. May have loose stones, signs of backfill erosion, collapsing areas, etc.	Rockery walls repaired or re-installed to design specifications. Professional engineer has been consulted as necessary for design/inspection.
Bottom Area	Visible Sediment Deposition	Visible sediment deposition in the rain garden that reduces drawdown time of water in the rain garden.	Bottom area is free of sediment deposition that reduces drawdown time.
	Accumulated Leaves or Dead Vegetation	Accumulated leaves in rain garden (may reduce infiltration capacity of rain garden or clog overflow).	Bottom and side slopes of rain garden are largely clear of leaves and other dead vegetation.
	Excessive Ponding	Excessive ponding water: Poned water remains in the basin more than 3 days after the end of a storm.	Rain garden drains within 3 days of the end of a storm.
Inlet (General)	Erosion at Inlet	Rock or cobble is removed or missing and concentrated flows are contacting soil.	Rock or cobble is present per design and concentrated flows are slowed/dispersed before soil contact.
Splash Block Inlet	Water Direction	Water is not being directed properly to the rain garden and away from the building.	Water is being directed to the rain garden per design, and is not flowing towards a building or other non-stormwater structure.
Pipe Inlet/Outlet	Reduced Pipe Capacity	Pipe capacity is reduced by sediment or debris (can cause backups and flooding).	Pipes are free of sediment and debris and are functioning properly per design.
	Damaged Pipes	Damaged/cracked drain pipes.	Damaged pipes have been repaired or replaced and inlet/outlet elements are functioning properly per design.
Vegetation	Poor Plant Health	Less than 75% of planted vegetation is healthy with a generally good appearance.	At least 75% of planted vegetation is healthy with generally good appearance. Any conditions found that were deleterious to plant health have been corrected where possible. Routine maintenance schedule has been updated as necessary to ensure continued plant health and satisfactory appearance.
	Overgrown Vegetation	Vegetation inhibits sight distances and sidewalks.	Sidewalks and sightlines on roadways are clear.
	Overgrown Vegetation	Vegetation is crowding inlets and outlets	Water inlets and outlets in the rain garden are clear of vegetation.

